



EE75 Series



Air / Gas Velocity
Transmitter

Manual

Hardware and Software

YOUR PARTNER IN SENSOR TECHNOLOGY



ELEKTRONIK®
Ges.m.b.H.

E+E Elektronik® Ges.m.b.H. doesn't accept warranty and liability claims neither upon this publication nor in case of improper treatment of the described products.

The document may contain technical inaccuracies and typographical errors. The content will be revised on a regular basis. These changes will be implemented in later versions. The described products can be improved and changed at any time without prior notice.

**© Copyright E+E Elektronik® Ges.m.b.H.
All rights reserved.**

USA

FCC notice:

This equipment has been tested and found to comply with the limits for a Class B digital device, pursuant to part 15 of the FCC Rules. These limits are designed to provide reasonable protection against harmful interference in a residential installation. This equipment generates, uses and can radiate radio frequency energy and, if not installed and used in accordance with the installation manual, may cause harmful interference to radio communications. However, there is no guarantee that interference will not occur in a particular installation. If this equipment does cause harmful interference to radio or television reception, which can be determined by turning the equipment off and on, the user is encouraged to try to correct the interference by one or more of the following measures:

- Reorient or relocate the receiving antenna.
- Increase the separation between the equipment and receiver.
- Connect the equipment into an outlet on a circuit different from that to which the receiver is connected.
- Consult the dealer or an experienced radio/TV technician for help.

Caution:

Any changes or modifications not expressly approved by the party responsible for compliance could void the user's authority to operate this device.

CANADIAN

ICES-003 notification:

This Device B digital apparatus complies with Canadian ICES-003.
Cet appareil numérique de la classe B est conforme à la norme NMB-003 du Canada.

TABLE OF CONTENTS

<u>HARDWARE</u>		
1. GENERAL		4
1.1 Symbol assertion		4
1.2 Safety instructions		4
1.3 Environmental information		4
2. PRODUCT DESCRIPTION		4
3. INSTALLATION		5
3.1 Installing the housing		5
3.2 Mounting Model A (wall mounting)		5
3.3 Mounting Model B (duct mounting)		5
3.4 Mounting Model P (duct mounting, pressure-tight to 10 bar)		6
3.5 Mounting Model C (remote probe)		6
3.6 Mounting Model E (remote probe, pressure-tight to 10 bar)		7
4. ELECTRICAL CONNECTIONS		8
4.1 Connection diagram		8
4.2 Connection diagram with plug connections (optional)		8
4.3 Assignment USB interface cable		8
5. OPERATING COMPONENTS		9
5.1 Circuit board		9
5.2 Jumpers for setting the output signal		9
5.3 Jumpers for setting the velocity response time		9
5.4 Display module with buttons (optional)		10
6. VELOCITY/TEMPERATURE CALIBRATION		11
6.1 Selecting the appropriate calibration method		11
6.1.1 General information on 1-point v/T calibration		11
6.1.2 General information on 2-point v/T calibration		11
6.2 Velocity calibration		12
6.2.1 Calibration procedure using configuration software		12
6.2.2 Calibration procedure using buttons on the display module (optional)		12
6.3 Temperature calibration		12
6.3.1 Calibration procedure using configuration software		12
6.3.2 Calibration procedure using buttons on the display module (optional)		12
6.4 Resetting to factory calibration		13
6.4.1 Resetting v/T to factory calibration		13
6.4.2 Resetting v to factory calibration		13
6.4.3 Resetting T to factory calibration		13
7. SELF-HELP / MAINTENANCE		14
8. REPLACEMENT PARTS / ACCESSORIES		14
9. TECHNICAL DATA		14
<u>CONFIGURATION SOFTWARE</u>		
1. GENERAL INFORMATION		15
2. INSTALLATION		15
2.1 Installing the USB-interface		15
2.2 Using the USB-interface		18
3. MENU ITEMS		18
3.1 File		18
3.2 Help		18
4. EE75 CONFIGURATOR		18
4.1 Start		18
4.2 Analog		19
4.3 Display		19
4.4 Response Time		19
4.5 Cross Section		20
4.6 Probe Cable		20
4.7 Switching off		21
4.8 Media Correction		21
4.9 Calibration		21
4.9.1 Information on 1-point v/T calibration		22
4.9.2 Information on 2-point v/T calibration		22
4.9.3 v calibration procedure using the configuration software		22
4.9.4 T calibration procedure using the configuration software		22
4.9.5 Activating factory calibration		22
4.10 Measuring Values		23
4.11 Information		23

1. GENERAL

This manual forms part of the scope of supply and serves to ensure proper handling and optimum functioning of the instrument.

Consequently, it is essential to read the manual before commissioning.

The manual is also to be brought to the attention of any person involved in transport, setup, operation, maintenance or repair.

This manual must not be used for competition purposes without the written consent of E+E Elektronik® and must not be forwarded to third parties.

Copies for personal use are permitted.

All information, technical data and illustrations contained in this manual are based on the information available at the time of publication.

1.1 Symbol assertion



This symbol indicates a safety instruction.

Safety instructions must always be followed. Failure to do so can result in injuries or damage, for which E+E Elektronik® accepts no liability.



This symbol indicates a note.

These notes should be observed to achieve optimum functioning of the equipment.



1.2 Safety instructions

- Excessive mechanical stress and improper use must be avoided.
- As the sensor element is sensitive to electrostatic discharge (ESD), appropriate protective measures should be taken when touching it.
- Installation, electrical connection, maintenance and commissioning must only be carried out by qualified personnel.



1.3 Environmental information



E+E Elektronik® products are developed with due consideration to all major environmental issues. Bearing this in mind, care should also be taken to avoid polluting the environment when disposing of equipment. When disposing of the transmitter, the individual components must be sorted according to type.

Electronic components must be kept together and disposed of in the proper manner for electronic scrap.

2. PRODUCT DESCRIPTION

The EE75 series velocity transmitters were developed to obtain accurate measuring results over a wide range of velocities and temperatures.

They have a robust metal housing to protect them against possible damage in rough industrial environments and come in five different models, providing a comprehensive range of mounting options:

- Model A for wall mounting
- Model B for duct mounting
- Model C with remote probe
- Model E with remote probe, pressure-tight to 10 bar (145psi)
- Model P duct probe, pressure-tight to 10 bar (145psi)

3. INSTALLATION



Before starting the installation please make sure that the upper and lower modules of the housings are not mixed up! Only with identical serial numbers the function of the transmitter can be guaranteed within the specifications (see chapter 9. "Technical Data").

all dimensions in mm

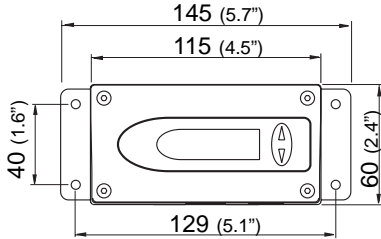

cross-section of bore:

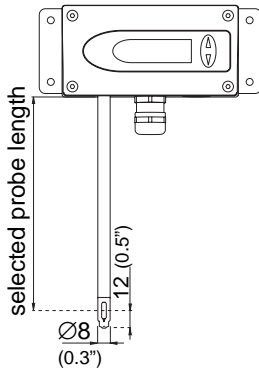
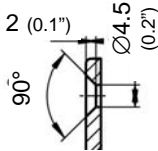

3.1 Installing the housing

1. On delivery, the two mounting brackets (on the left and right of the housing base plate) are attached to the lower part of the housing with two screws each, facing inwards. For installation, the brackets can be swung out and screwed down (see drawing).
2. The dimensions of the mounting holes are as shown in the adjacent drawing.
3. The bottom part of the housing is fitted using 4 screws (not included). Max. screw diameter 4.5 mm (0.18"), for example 4.2 x 38mm (0.17 x 1.5") - DIN 7983H screws.
4. Connecting the transmitter (see Section 4 - Electrical Connections)
5. Lift the upper part of the housing into position and screw it into place using the four Allen screws included (Allen key provided).

3.2 Mounting Model A (wall mounting)

See Section 3.1 - Installation of the housing

3.3 Mounting Model B (duct mounting)

There are two types of duct mounting:

3.3.1 Mounting with brackets

See Section 3.1 - Installation of the housing

OR:

3.3.2 Mounting with a flange

The stainless steel mounting flange allows for the transmitter to be mounted on the outside wall of the duct in which the measurement takes place and adjusted to any insertion depth.

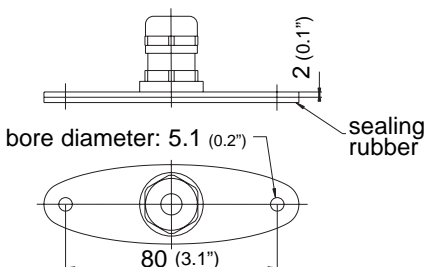
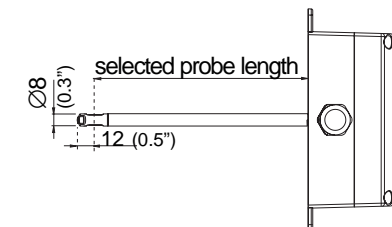

Hardware

3.4 Mounting Model P (duct mounting, pressure-tight to 10 bar / 145psi)



General safety instructions for installation using pressure-tight movable screw connections

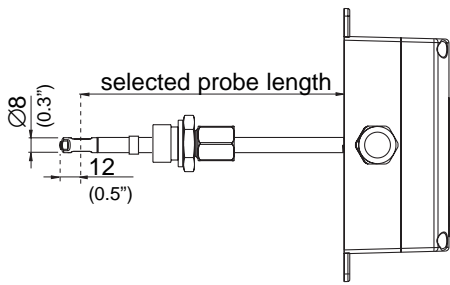

As the sensing probe can be exposed to very high pressures in the measuring environment, there is a risk of sudden, unintentional expulsion of the probe during or after improper installation. Special care should therefore be taken when working on or in the vicinity of the sensing probe. Do not, under any circumstances, bend directly over the probe.

When installing the sensor probe, be careful not to damage the surface of the sensing probe.

This could damage the seals (resulting in leakage and pressure loss) or cause problems when removing the probe (may get stuck).

Before installing the sensing probe, make sure it is free from any impurities such as grease or dirt.

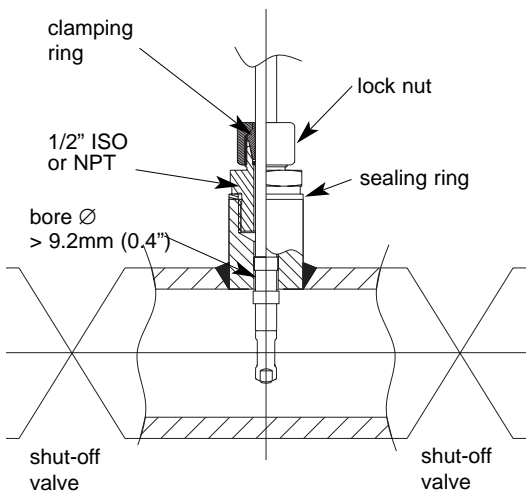

Installing the probe

There should be a shut-off valve on both sides of the probe insert when installing the probe. This makes it easy to remove the transmitter for maintenance and calibration.

1. Install the probe with the shut-off valves closed.
2. Insert the sensor probe into the process.
3. To ensure the probe is installed securely, the lock nut must be tightened to a specified torque of 10 Nm. If no torque spanner is available, tighten the lock nut by hand as far as possible and then turn it a further $\sim 90^\circ$ with an appropriate open-ended spanner.



An inadequate torque results in a low tension force (fixing force) on the clamping sleeve. This brings with it a risk of injury due to sudden expulsion of the sensing probe. An excessive torque can lead to permanent deformation of the clamping sleeve and sensing probe, making removal and re-installation more difficult or even impossible.

Removing the probe



1. If the sensor probe is installed in a pressure chamber, make sure that the **pressure in the chamber and the ambient pressure are in equilibrium before removing the probe.**
2. Hold the sensing probe/housing firmly. (Attention: Do not bend the connection cable)
3. Slowly loosen the lock nut using a spanner (spanner width 24).
4. The entire probe can now be removed.

3.5 Mounting Model C (remote probe)

3.5.1 Installing the housing

See Section 3.1 - Installing the housing

3.5.2 Installing the probe

See Section 3.3.2 - Mounting with a flange

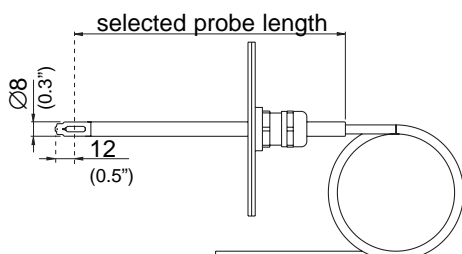

Hardware

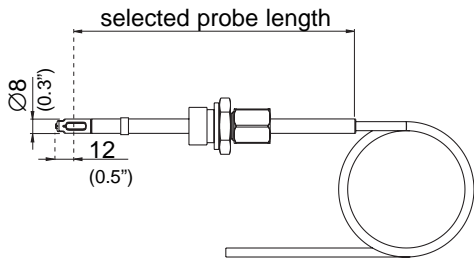

3.6 Mounting Model E (remote probe, pressure-tight to 10 bar / 145psi)

3.6.1 Installing the housing

See Section 3.1 - Installing the housing

3.6.2 Installing the probe

See Section 3.4 - Mounting Model P (duct mounting, pressure-tight to 10 bar)



General installation instructions:

Scaling the insertion depth on the probe

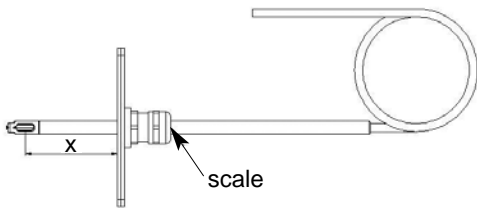

The insertion depth can be read off directly on the probe. The depth is measured from the centre of the velocity measuring slot (= middle of the sensor). The scaling on the probe has an offset of 30mm (1.2"). This allows for the insertion depth "X" (= distance between middle of sensor and mounting plate) to be read off directly above the screwed cable gland (see sketch).

Flow direction

Flow direction:

The arrow on the sensor probe should be pointing exactly in the direction of flow!

- ⊙ indicates the orientation of the tip of the arrow.
- ⊗ indicates the orientation of the tail of the arrow.



Model A (wall mounting):

- ⊙ indicates the orientation of the tip of the arrow.

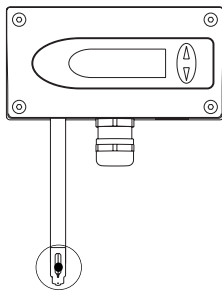

Models B and P (duct mounting):

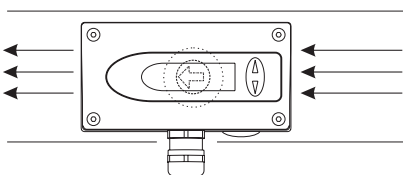

Models C and E (remote probe):

To be able to read off the orientation of the remote sensor head beyond the measuring line, a mark • has been punched at the end of the sensing probe. This corresponds with: ⊙ flow

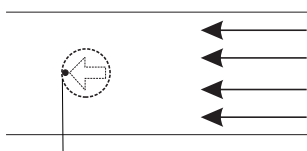

- ⊙ corresponds to the tip of the arrow

4. ELECTRICAL CONNECTIONS

4.1 Connection diagram

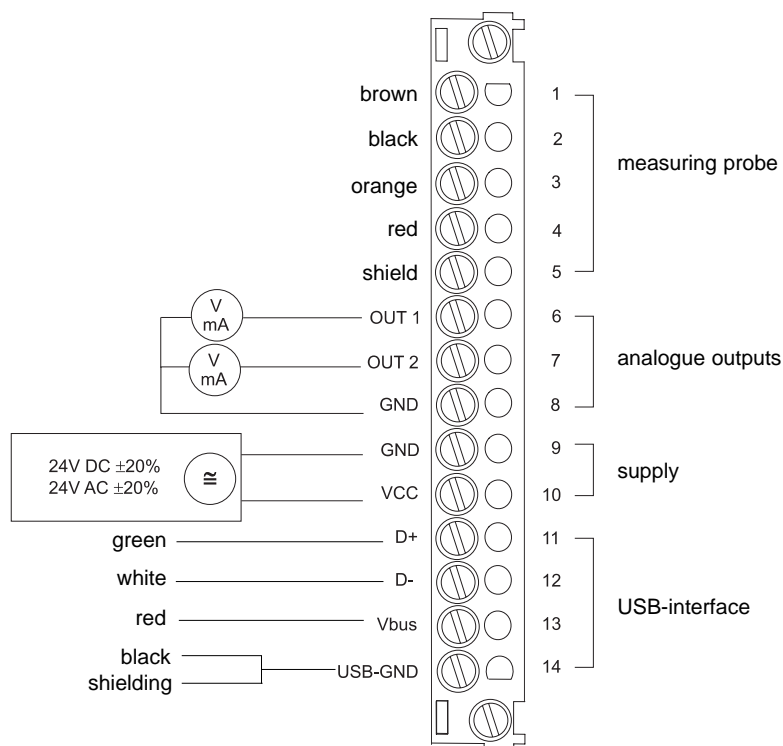

4.2 Connection diagram with plug connections (optional)

Coupling for supply and analogue outputs (front view)



Euro-Standard

Description:

VCC
GND
GND
OUT2
OUT1

Connection assignment:

5
4
3
2
1

Plug for USB interface (front view)

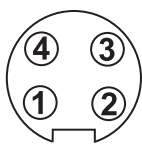

Euro-Standard

Description:

D+
D-
V-bus
GND

Connection assignment:

3
1
2
4



Cable connection to the plugs should be as indicated by the numbers above.

4.3 Assignment USB - interface cable

colour of wire:

green

white

red

black

shielding

signal:

D+

D-

Vbus

USB-GND

terminal no.:

11

12

13

14

5. OPERATING COMPONENTS

5.1 Circuit board

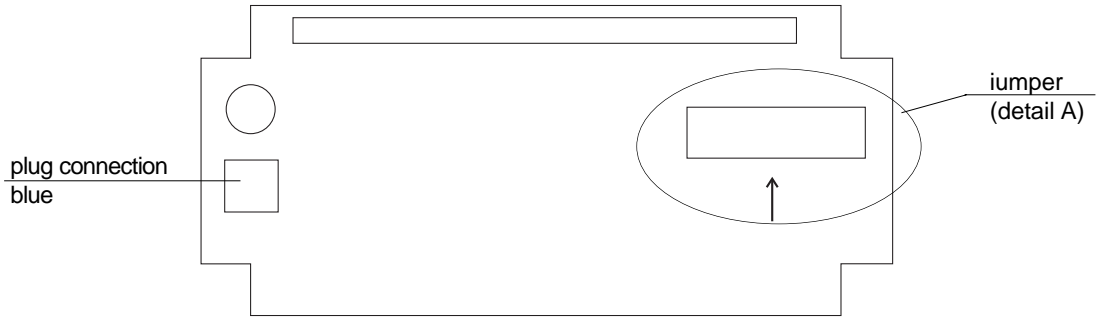

detail A:

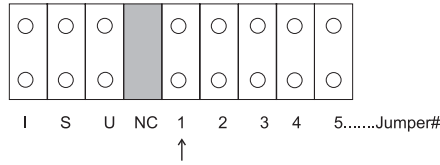

Jumper#

I
S
U
1 (arrow)
2
3
4
5

Function

current output signal
signal
voltage output signal
 τ_{90-1} -velocity (2s)
 τ_{90-2} -velocity (4s)
 τ_{90-3} -velocity (10s)
free
free

5.2 Jumpers for setting the output signal

If the transmitter output signal is set from current to voltage by use of the configuration software, additionally 2 jumpers must be set on the circuit board as follows:

EE75-VTx6

(for current output, e.g. 4-20mA)

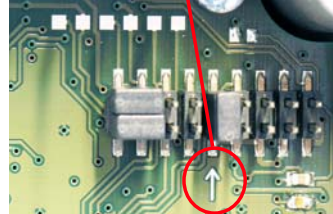
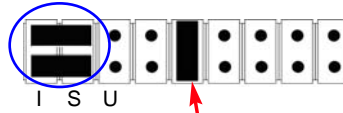

EE75-VTx3

(for voltage output, e.g. 0-10V)

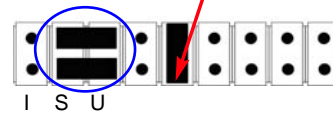

5.3 Jumpers for setting the velocity response time

The EE75 series allows users to set the velocity response time:

a) Setting the velocity response time using jumpers:

Jumper position (Also see Section 5.1 - Circuit board):

no jumper
jumper at pos. 1
jumper at pos. 2
jumper at pos. 3

Response time:

1.5sec
2sec (factory setting)
4sec (factory setting)
10sec (factory setting)

b) Setting the velocity response time using configuration software:

The response time (τ_{90}) can also be set to any value between 1.5 and 40 s using the configuration software, without changing the jumpers on the circuit board. See Configuration Software, Section 4.4 - Response Time.

5.4 Display module with buttons (optional)

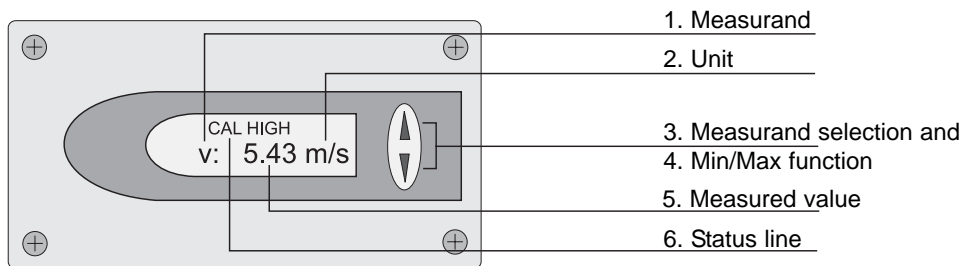

1. MEASURAND:		2. UNIT:		3. MEASURAND SELECTION:
SI		SI	US	
v	Velocity	m/s	ft/min	Pressing the Δ or ∇ button switches between the various physical quantities (measurands).
T	Temperature	$^{\circ}\text{C}$	$^{\circ}\text{F}$	
\bar{v}	Volume	m^3/min	ft^3/min	

4. MIN / MAX FUNCTION:

The MIN/MAX function can be used to record the lowest and highest values measured for each measurand since the last reset or the last interruption of the power supply.

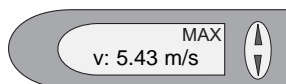

Highest measured value: MAX

1. Select the required measurand (UP / DOWN button)
2. To display the maximum value, press the UP button and hold it for approx. 5 s.
3. To return to the normal operating mode, press the UP button again and hold it for approx. 5 s.

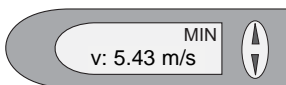

Lowest measured value: MIN

1. Select the required measurand (UP / DOWN button)
2. To display the minimum value, press the DOWN button and hold it for approx. 5 s.
3. To return to the normal operating mode, press the DOWN button again and hold it for approx. 5 s.

By pressing the UP and DOWN buttons simultaneously in normal operating mode the stored MIN/MAX values for all measurands can be reset by selecting "CLEAR MIN/MAX BUFFER"; recording can then be restarted (for details see Section 5.3 - Display module with buttons, point 7 - Menu navigation).

5. MEASURED VALUE:

The measured value of the respective measurand is indicated.

6. STATUS LINE:

The status line indicates the transmitter's current operating status:

- no indication: normal operating mode / measurement in progress
- MIN or MAX: see point 4 - MIN/MAX function
- CAL LOW: V or T calibration routine for the low adjustment point selected.
- CAL HIGH: V or T calibration routine for the high adjustment point selected.

7. MENU NAVIGATION:

Pressing the UP and DOWN buttons simultaneously for approx. 5 s during a measurement (in normal operating mode) a 4-line menu is displayed with the following options:

- CALIBRATION: (Calibration)
- FACTORY SETTINGS: (Factory settings)
- CLEAR MIN/MAX BUFFER: (Clear Min/Max buffer)
- EXIT: (returns to normal operating mode without executing any of the menu items)

Pressing the UP and DOWN buttons moves the cursor ">" on the left-hand side of the display up and down to select one of the adjacent menu items.

Pressing the UP and DOWN buttons simultaneously for approx. 5 s confirms the selection and executes the selected menu item.

6. VELOCITY/TEMPERATURE CALIBRATION

The EE75 can be calibrated / adjusted using either the buttons on the optional display module or the USB interface and configuration software provided.

6.1 Selecting the appropriate calibration method (1-point or 2-point calibration)

The EE75 transmitter series can be calibrated in 2 different ways:

- 1-point v/T calibration:
Quick and easy option for obtaining precise measuring results at a specific working point. 1-point calibration should only be used for very limited working ranges.
- 2-point v/T calibration:
With 2-point calibration, precise measuring results can be obtained over the entire v/T measuring range. The more complicated 2-point calibration procedure is preferable to 1-point calibration, if higher precision or a wider working range is required.

6.1.1 General information on 1-point v/T calibration:

If possible the selected calibration point should be similar to the working point (of the limited working range) of the transmitter.

Example: Working range v 8 - 12m/s (1600 - 2400ft/min) > calibration point at 10m/s (2000ft/min); working range T 18 - 22°C (64.4 - 71.6°F) - > calibration point at 20°C (68°F).

- If the selected calibration point is < 50% of the max. measuring range, V/T-CAL LOW should be selected for calibration / adjustment.
- If the selected calibration point is > 50% of the max. measuring range, V/T-CAL HIGH should be selected for calibration / adjustment.

Example: v measuring range 0 - 10m/s (0 - 2000ft/min); actual working range 6 - 8m/s (1200 - 1600ft/min); selected calibration point 7m/s (1400ft/min); perform 1-point calibration, selecting V-CAL HIGH.

6.1.2 General information on 2-point v/T calibration:

With 2-point calibration, v/T calibration / adjustment is performed at 2 different calibration points.

To ensure the smallest possible deviation in measuring results over the entire measuring range, the two calibration points should be selected as follows:

- The low calibration point should be in the lower third of the measuring range. Calibration / adjustment must be performed using the V/T-CAL LOW function.
- The high calibration point should be in the upper third of the measuring range. Calibration / adjustment must be performed using the V/T-CAL HIGH function.

Example: EE75 vT**1 - measuring range = 0 - 2m/s (0 - 400ft/min).
Low calibration point (V-CAL LOW) should be around 0.4 m/s (0...0.7).
High calibration point (V-CAL HIGH) should be around 1.8 m/s (1.4...2).

6.2 Velocity calibration

6.2.1 Calibration procedure using configuration software

See Configuration Software, Section 4.9.3 - v calibration process using a configurator

6.2.2 Calibration procedure using buttons on the display module (optional)

1. Position the sensor head in the middle of the reference system (wind tunnel).
2. Stabilise the probe at the reference velocity (for at least 1 minute). The temperature of the measuring probe and the reference system must be approximately the same.
3. Press both buttons for approx. 5 s to display the menu window.
4. Use the buttons and cursor so select the menu item "CALIBRATION" and confirm the selection.
5. Select "V-Cal" and confirm the selection.
- 6.1 "1-point calibration":
 - Select the calibration point as described in Section 6.1.1.
 - If calibration point > 50% of measuring range, select "V-CAL HIGH" and confirm the selection.
 - If calibration point < 50% of measuring range, select "V-CAL LOW" and confirm the selection.
- 6.2 "2-point calibration":
 - Select the low (high) calibration point as described in Section 6.1.2.
 - Approach the low (high) calibration point in the reference system, select "V-CAL LOW" ("V-CAL HIGH") on the transmitter and confirm the selection.
7. The status line should display either CAL LOW (CAL HIGH).
8. The measuring value can now be adjusted with the reference value in 0.1 m/s (20ft/min) increments by pressing the UP or DOWN button. The updated value is displayed immediately and present at the analogue output.
9. To save the adjusted measuring value in the instrument, press both buttons simultaneously for approx. 5 s, then select "YES" in the "SAVE" menu and confirm the selection. This exits the calibration routine and the transmitter returns to normal operating mode.

Selecting "NO" in the "SAVE" menu exits the calibration routine without saving the adjusted measuring value.
10. In the case of 1-point v calibration, the procedure is now complete.
11. For 2-point v calibration, repeat steps 6.2-9 with the (high) calibration point.

6.3 Temperature calibration

6.3.1 Calibration procedure using configuration software

See Configuration Software, Section 4.9.4 - T calibration procedure using a configurator

6.3.2 Calibration procedure using buttons on the display module (optional)

1. Insert the sensor head in the temperature reference system.
2. Allow it to stabilise (min. 15 minutes). The greater the difference in temperature between the measuring probe and the reference system, the longer the required stabilisation time.

3. Press both buttons for approx. 5 s to display the menu window.
4. Use the buttons and cursor to select the menu item "CALIBRATION" and confirm the selection.
5. Select "T-Cal" and confirm the selection.
- 6.1 "1-point calibration":
 - Select the calibration point as described in Section 6.1.1.
 - If calibration point > 50% of measuring range, select "T-CAL HIGH" and confirm the selection.
 - If calibration point < 50% of measuring range, select "T-CAL LOW" and confirm the selection.
- 6.2 "2-point calibration":
 - Select the low (high) calibration point as described in Section 6.1.2.
 - Approach the low (high) calibration point in the reference system, select "T-CAL LOW" ("T-CAL HIGH") on the transmitter and confirm the selection.
7. The status line should display either CAL LOW (CAL HIGH).
8. The measuring value can now be adjusted with the reference value in 0.1°C (32.18°F) increments by pressing the UP or DOWN button. The updated value is displayed immediately and present at the analogue output.
9. To save the adjusted measuring value in the instrument, press both buttons simultaneously for approx. 5 s, then select "YES" in the "SAVE" menu and confirm the selection. This exits the calibration routine and the transmitter returns to normal operating mode.

Selecting "NO" in the "SAVE" menu exits the calibration routine without saving the adjusted measuring value.
10. In the case of 1-point T calibration, the procedure is now complete.
11. For 2-point T calibration, repeat steps 6.2-9 with the (high) calibration point.

6.4 Resetting to factory calibration

If necessary the transmitter can be reset to the factory settings (factory calibration data), after a v or T customer calibration has been performed.

6.4.1 *Resetting v/T to factory calibration:*

1. Press both buttons for approx. 5 s to display the menu window.
2. Select "Factory settings" and confirm the selection.
3. Select "Restore Settings" and confirm the selection.
4. The customer calibration data (v, T) has now been reset to the factory calibration data.

6.4.2 *Resetting v to factory calibration:*

1. Press both buttons for approx. 5 s to display the menu window.
2. Select "Calibration" and confirm the selection.
3. Select "V-CAL" and confirm the selection.
4. Select "V-FACTORY SETTINGS" and confirm the selection.
5. Select "Restore Settings" and confirm the selection.
6. The customer calibration data (v) has now been reset to the factory calibration data.

6.4.3 *Resetting T to factory calibration:*

1. Press both buttons for approx. 5 s to display the menu window.
2. Select "Calibration" and confirm the selection.
3. Select "T-CAL" and confirm the selection.
4. Select "T-FACTORY SETTINGS" and confirm the selection.
5. Select "Restore Settings" and confirm the selection.
6. The customer calibration data (T) has now been reset to the factory calibration data.

7. SELF-HELP / MAINTENANCE



- If the measuring values are unrealistic, the first thing to check is the angle of inflow.
- Also check the sensor element for soiling. If dust has collected on the element, blow it off carefully with oil-free compressed air. If there is anything else on the sensor, clean it carefully using isopropyl alcohol and allow it to dry. Do not touch the velocity sensor with your fingers!
- If there is no output and indication, check the power supply.

8. REPLACEMENT PARTS / ACCESSORIES

- Stainless steel mounting plate HA010207
- USB interface cable HA010310

9. TECHNICAL DATA

Measuring value

Air velocity

Working range	0... 2m/s (0...400ft/min)	
	0... 10m/s (0...2000ft/min)	
	0... 40m/s (0...8000ft/min)	
Accuracy ¹⁾ in air at 25°C (77°F) ²⁾ at 45% RH and 1013hPa	0.06... 2m/s (12...400ft/min)	± 0.03m/s / 6ft/min
	0.15...10m/s (30...2000ft/min)	± (0.10m/s / 20ft/min + 1 % of measuring value)
	0.2... 40m/s (40...8000ft/min)	± (0.20m/s / 40ft/min + 1 % of measuring value)
Uncertainty of factory calibration ¹⁾	± (1% of measuring value, min. 0.015m/s (3ft/min))	
Temperature dependence electronics	typ. -0.005 % of measuring value / °C	
Temperature dependence probe	± (0.1% of measuring value/°C)	
Dependence	of angle of inflow:	< 3% for $\alpha < 20^\circ$
	of direction of inflow:	< 3%
Response time τ_{90} ³⁾	< 1.5...40s (configurable)	
Temperature		
Working range	probe:	-40...120°C (-40...248°F)
	probe cable:	-40...105°C (-40...221°F)
	electronic:	-40...60°C (-40...140°F)
	electronic with display:	-30...60°C (-22...140°F)
Accuracy at 20°C (68°F)	±0.5°C (±0.9°F)	
Temperature dependence electronics	typ. -0.01°C / °C	
Response time τ_{90} ³⁾	10s	

Outputs

output signals and display ranges are freely scaleable (see ranges below)

voltage	0-10V (e.g: 0-5V, 1-5V etc.)	-1mA < I_L < 1mA
current (3-wire)	0-20mA (e.g: 4-20mA etc.)	$R_L < 350 \text{ Ohm}$
v-scaling	0...2 / 10 / 40m/s (0...400 / 2000 / 8000ft/min)	
T-scaling	-40...120°C (-40...248°F)	
Vol-scaling	0...10000m ³ /min (0...353147ft ³ /min)	

General

Supply voltage	24V DC/AC ± 20%	
Current consumption	max. 100mA; max. 160mA (with display)	
Connection	screw terminals max. 1.5mm ² (AWG 16)	
Electromagnetic compatibility	EN 61000-6-3	ICES-003 ClassB
	EN 61000-6-2	FCC Part15 ClassB
Pressure range	Model E and P pressure tight up to 10bar (145psi)	
Material	housing / protection class:	metal (AISI3Cu) / IP65; Nema 4
	measuring probe:	stainless steel
	measuring head:	PBT (polybutylenterephthalat)
System requirements for configuration software	Windows 2000 or Windows XP	
Interface	USB 1.1	

1) The accuracy statement includes the uncertainty of the factory calibration with an enhancement factor k=2 (2-times standard deviation).
The accuracy was calculated in accordance with EA-4/02 and with regard to GUM (Guide to the Expression of Uncertainty in Measurement).
2) Accuracy refers to measurement in air
3) Response time τ_{90} is measured from the beginning of a step change to the moment of reaching 90% of the step.

CONFIGURATION SOFTWARE

LIMITED LIABILITY

E+E Elektronik® shall not be held liable for any damages or consequential damages (for example, but not restricted to, loss of earnings, interruption of business, loss of information and data or any other financial losses) resulting from the installation, use or impossibility of use of an E+E Elektronik® software product and any associated support services or non-performance of support services.

1. GENERAL INFORMATION

The configuration software included in the scope of supply provides a user-friendly alternative to the use of the buttons on the optional display module for adjusting the transmitter to suit the relevant application or to calibrate / adjust the velocity and temperature settings. System requirements: Windows 2000 or Windows XP, USB 1.1 interface

2. INSTALLATION



NOTE:

Administrator authorisations may be required for problem-free installation of the EE75 configuration software.



1. Insert the CD-ROM supplied in the appropriate drive on your PC.
2. **Do NOT yet connect the EE75 to the PC using the USB Port.**
3. Run "Setup.exe" to install the EE75 configuration software.
4. The InstallShield Wizard for the EE75 configurator is launched.
5. Follow the instructions to install the software.
6. Clicking the "Finish" button completes configuration software installation.

2.1 Installing the USB-interface



NOTE:

The USB interface software must also be installed to allow your PC and the EE75 velocity transmitter to communicate properly.

1. **You can now connect the EE75 to your chosen USB Port on your PC (max. transmission distance 3 m).**
2. The menu window shown below appears:



3. Select "No, not this time" and then "Next" to bring up the next menu window.



4. Select "Install the software automatically" and "Next" to continue installation.



5. Please ignore the Windows logo test prompt shown above by clicking "Continue Anyway".



Note: The EE75 velocity transmitter is not recognised as standard Microsoft hardware, triggering the prompt shown above.

E+E expressly states that continuing installation will result in neither technical nor legal problems for the user.



6. Clicking "Finish" closes the Found New Hardware Wizard.

If the EE75 configuration software and the associated USB interface have been set up correctly, a connection has been assigned to the EE75 USB to UART Bridge Controller on your PC's Control Panel.

See Start/Settings/Control Panel/System/Hardware/Device Manager

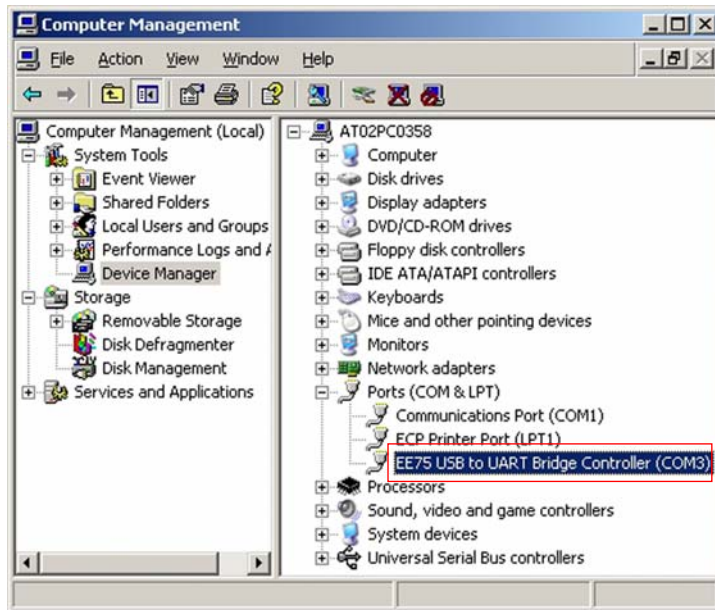

7. The configuration software can now be opened by double-clicking the EE75 icon on your desktop.

8. Specify the selected USB Port (for details, see Configuration Software, Section 3.1 - File)



9. Pressing the "Read" button will start the communication with the EE75 and downloads its configuration.

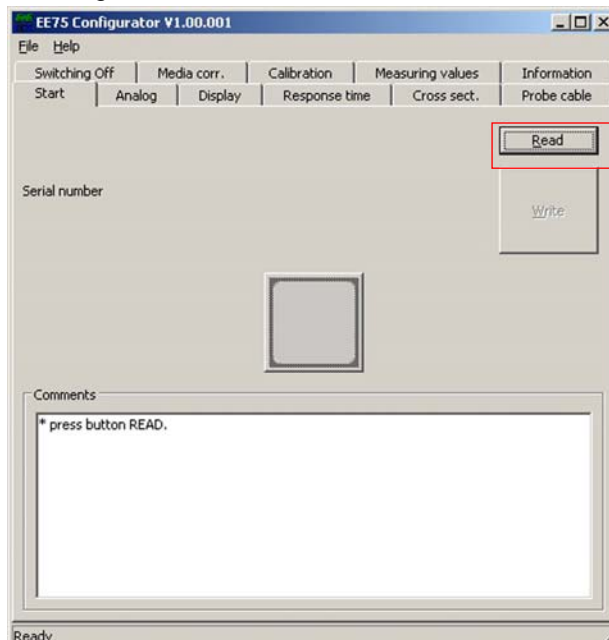

2.2 Using the USB-interface



Install configuration software and USB-interface (refer to manual "configuration software", chapter 2).
Important: Starting the procedure the transmitter should be disconnected from any power supply!

1. Connect terminals and USB-interface located in the back module of the EE75 housing under zero-potential conditions
2. Replace and secure the upper module of the housing
3. Connect EE75 to the supply voltage (VCC)
4. Connect the computer with the EE75 using the USB interface cable
Attention: Connect USB-cable first to EE75 and afterwards to PC
5. Start configuration software
6. Enter assigned COM-port-number, which can be found in the system properties of MS Windows:
Start -> Settings -> Control Panel -> System -> Hardware -> Device Manager -> Ports (COM and LPT) – expand to Communications Port
7. Enter configuration modifications
Attention: USB-connection must not be disconnected during configuration process due to the possibility that this could cause a hang-up of the USB-interface of the PC. In that case please close EE75 configuration software while USB-connection is interrupted. Thereafter please proceed again from point 4.
8. Exit configuration software
9. Disconnect the USB interface cable at the computer first; than disconnect the EE75 transmitter!

3. MENU ITEMS

3.1 File

Load Settings:

Opens the saved transmitter configuration settings from an archive file on the PC.

Save Settings:

Saves the displayed configuration settings in an archive file on the PC.

Select COM Port:

Selects the USB interface used on your PC.

If the "Remember next time" box is checked, the selected interface will always be used in future.
The number of the USB Port can be found under:

Start -> Settings -> Control Panel -> System -> Hardware -> Device Manager



Exit:

Closes the configuration software.

3.2 Help

Provides general information on the configuration software.

4. EE75 CONFIGURATOR

4.1 Start

The "Start" tab is used to initiate communication with the connected transmitter.

Read:

This function downloads the current transmitter configuration and serial number.

Write:

The configuration changes made on the other tabs can be uploaded to the transmitter using the "Write" command.



Note: Execute the "Read" function before making any new configuration change!



4.2 Analog

The "Analog" tab allows free configuration and scaling of the two analogue outputs

Range:

The drop-down input field is used either to select a standardised output signal (0-5 V, 0-10 V, 0-20 mA, 4-20 mA) or to specify a user-defined current/voltage output range (e.g. 1-9 V).

Measurement value:

Specifies the physical quantities the outputs will represent.



If the measurement value "volumetric flow rate" is selected, the cross section has to be defined (see chapter 4.5 cross section).

Upper / Lower Limit:

Specifies the required display range. The limits must lie within the maximum span as indicated.

Physical quantity:

Allows a user to choose whether measuring results are displayed and output in SI units (m/s; °C; m³/min) or US units (ft/min.; °F; ft³/min.).

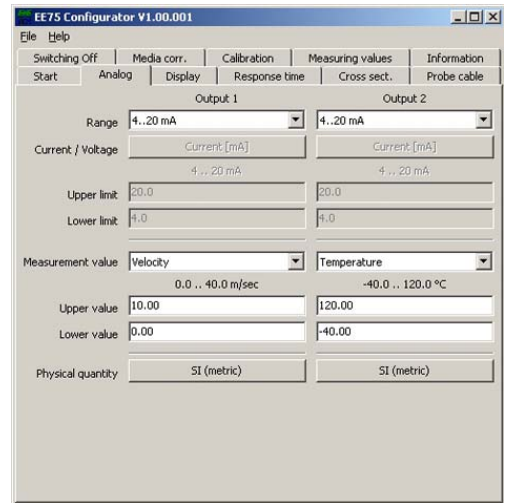

4.3 Display

With an optional display, the following can be set on the Display tab:

"Display Mode" drop-down input field:

- Single-line display
- Two-line display (factory setting)

"Backlight on" check box

- Activated = ON
- Not activated = OFF

4.4 Response Time

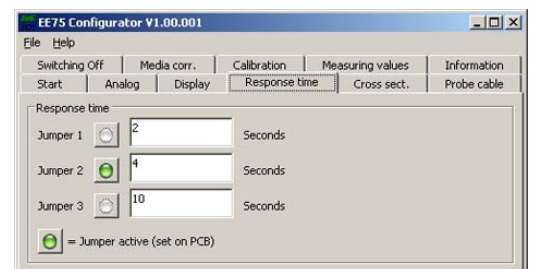

As described under Hardware, Section 5.2 - Jumpers for setting the velocity response time, three different response times can be set.

In the factory settings, the following response times are assigned to the 3 jumper positions:

Jumper at position 1: $\tau_{90} = 2$ s

Jumper at position 2: $\tau_{90} = 4$ s

Jumper at position 3: $\tau_{90} = 10$ s

Users can also assign a response time of between 1.5 and 40 s to each jumper position using the configuration software.

Example:

Jumper at position 1: changes from 2 s (factory setting) to 35 s.

The green pilot lamp next to the jumper position indicates which jumper position is currently set and consequently active.



Note: If the response time of the jumper currently active is changed and uploaded using the "Write" function, the transmitter's velocity response is switched without changing the hardware (jumper position).

4.5 Cross Section

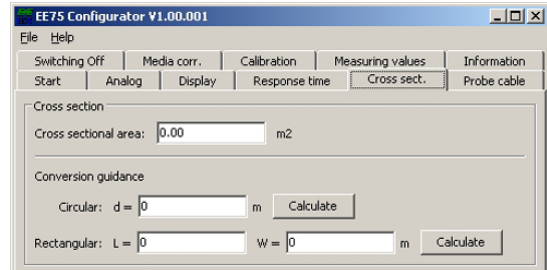

The EE75 allows volumetric flow to be displayed in [m³/min] or [ft³/min.] (see Hardware, Section 5.3 - Display module with buttons - Measurands).

The volume is calculated based on the flow velocity measured and the cross section. Consequently, the cross sectional area of the duct must be entered in [m²] or [ft²].

To make it easier to calculate the cross sectional area, the "Cross sect." tab provides input assistance:

Circular:

Measure and enter the duct diameter in [m] or [ft]

- Press "calculate"
- The cross section is calculated and entered in the "Cross sectional area" field

Rectangular:

Measure and enter the duct length and width in [m] or [ft]

- Press "calculate"
- The cross section is calculated and entered in the "Cross sectional area" field

If the duct has a different shape or the cross-sectional area is already known, the value can, of course, also be entered directly in the "Cross sectional area" field, in [m²] or [ft²].

4.6 Probe Cable

The length of the probe cable (transmitter with remote probe) should not normally be changed.

However, if it is necessary to do so, the new (modified) probe cable length must be entered on the "Probe Cable" tab. This virtually rules out additional measuring errors due to the modified cable length.

Example: You order an EE75 VTC***K500 (5m / 16.4ft cable length) and then cut the cable with 3m (9.8ft). The new cable length of 2m (6.6ft) should be entered and uploaded using the "Write" function.



Notes:

- The cable length is measured from the centre of the sensor element in the sensor head to the point where it enters the housing (PG / screw connection).
- To increase the length of the probe cable, the instrument must be returned to E+E Elektronik.

4.7 Switching Off

The low flow cut-off is intended to prevent the display or output signal fluctuating if the flow is cut off. Small differences in temperature in the duct can produce small flow fluctuations, which would be recorded by the transmitter without the low flow cut-off.

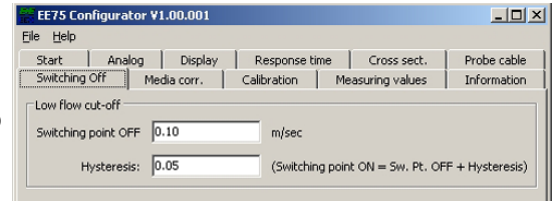

Switching point OFF and Hysteresis: (switching point OFF + hysteresis = switching point ON) can be defined in the input fields of the "Switching Off" tab.



Note:

The EE75 comes with the low flow cut-off function activated, with a switching point OFF of 0.1m/s (20ft/min) and a hysteresis of 0.05m/s (10ft/min).

Should you require smaller flow velocities to be displayed, deactivate the low flow cut-off (switching point OFF + hysteresis = 0m/s or ft/min.).

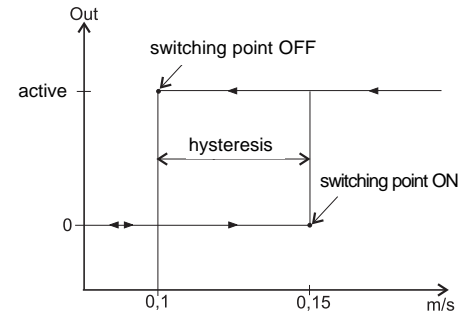

4.8 Media Correction

E+E thin film sensor elements are based on the hot film anemometer principle and record the mass flow rate of a medium. This mass flow rate is significantly affected by the pressure and relative humidity of the medium.

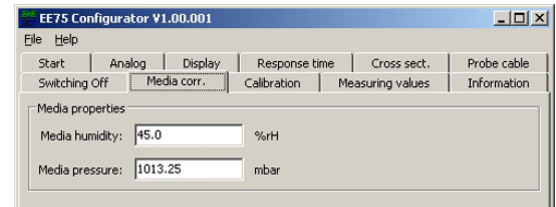

The EE75 is standardised to 45% relative humidity and an air pressure of 1013.25 mbar at the factory. If the media pressure is significantly different, the actual values can be defined in the input field on the "Media corr." tab to obtain the best possible measuring results.

4.9 Calibration

Velocity and temperature calibration is not only possible using the buttons on the integrated display, the EE75 can also easily be calibrated / adjusted using the configuration software.

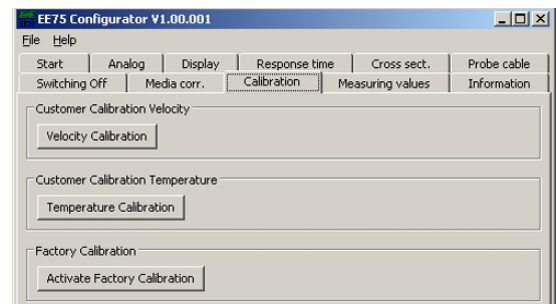

Note:

The configuration software automatically distinguishes between the low and high calibration points.

- If the selected calibration point is BELOW the centre of the measuring range, it is automatically recognised as the "low calibration point" (CAL LOW).

- If the selected calibration point is ABOVE the centre of the measuring range, it is automatically recognised as the "high calibration point" (CAL HIGH).

Example:

EE75 VT**1: Measuring range = 0-2m/s (0-400ft/min) -> centre of measuring range = 1m/s (200ft/min)

- 0.5m/s (100ft/min) -> calibration point lies below 1m/s (200ft/min) -> CAL LOW

- 1.6m/s (300ft/min) -> calibration point lies above 1m/s (200ft/min) -> CAL HIGH

4.9.1 Information on 1-point v/T calibration

If possible the selected calibration point should be similar to the working point (of the limited working range) of the transmitter.

Example:

Working range v 8 - 12m/s (1600 - 2400ft/min) > calibration point at 10m/s (2000ft/min);
working range T 18 - 22°C (64.4 - 71.6°F) > calibration point at 20°C (68°F).

4.9.2 Information on 2-point v/T calibration

v/T calibration / adjustment is performed at 2 different calibration points. To ensure the smallest possible deviation in measuring results over the entire measuring range, the two calibration points should be selected as follows:

- The low calibration point should be in the lower third of the measuring range.
- The high calibration point should be in the upper third of the measuring range.

Example:

EE75 vT**1 - measuring range = 0 - 2 m/s (0 - 400ft/min)

- Low calibration point (V-CAL LOW) should be around 0.4 m/s (0...0.7).
- High calibration point (V-CAL HIGH) should be around 1.8 m/s (1...4-2).

4.9.3 v calibration procedure using the configuration software

1. Position the sensor head in the middle of the reference system (wind tunnel).
2. Set the required calibration point in the reference system (wind tunnel).
3. Stabilise the probe at the reference velocity (for at least 1 minute).
4. Clicking on the "Velocity calibration" button opens the menu window shown below.

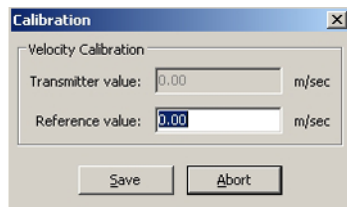

5. Enter the velocity displayed by the reference system in the "Reference value" input field.
6. Clicking "Save" adjusts the EE75 measuring value with the reference value.
7. In the case of 1-point calibration, the process is now complete.
8. For 2-point calibration, repeat steps 2-7.

4.9.4 T calibration procedure using the configuration software

Click on the "Temperature calibration" button. The 1 or 2-point temperature calibration procedure is similar to the velocity calibration (see Section 4.9.3 - v calibration process using a configurator).

4.9.5 Activating factory calibration

Clicking the "Activate factory calibration" button deletes the customer calibration data set for velocity and temperature and restores the factory settings.

4.10 Measuring Values

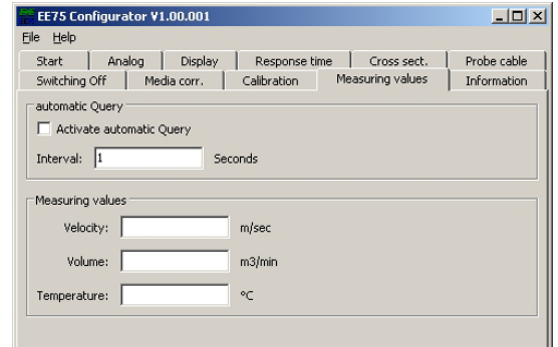

The configuration software allows the EE75 measuring values to be queried periodically on the "Measuring Values" index card.

If the "Activate automatic Query" function is activated, all measuring values are downloaded according to the specified interval and displayed in the desingated fields.

This function is particularly useful for checking transmitters, which do not have the (optional) display module.

4.11 Information

The "Information" tab contains general information on the transmitter. It also saves the date of the last customer calibration done with the configuration software.

Model:

Type of transmitter.

Serial number:

Reference to the serial number of the connected transmitter.

Software version:

Version of the firmware used.

Production date:

Date of production.

Last customer V adjustment:

Date of last velocity adjustment.

Last customer T adjustment:

Date of last temperature adjustment.

HEAD OFFICE:

E+E ELEKTRONIK Ges.m.b.H.

Langwiesen 7

A-4209 Engerwitzdorf

Austria

Tel: ++43/7235/605-0

Fax: ++43/7235/605-8

info@epluse.com

TECHNICAL OFFICES:

E+E CHINA

B0820, Hui Bin Office Building,

No. 8, Bei Chen Dong St., Chao Yang District,

Beijing 100101, P.R. China

Tel: ++86/10/84992361; ++86/10/84992362

Fax: ++86/10/84992363

info@epluse.cn

E+E FRANCE

Le Norly III; 136 chemin du Moulin Caron

F-69130 Ecully

Tél : ++33/4 7472 35 82

Fax : ++33/4 7833 44 39

info@epluse.fr

E+E GERMANY

Schöne Aussicht 8c

D-61348 Bad Homburg

Tel: ++49/6172/13881 0

Fax: ++49/6172/13881 26

info@ee-elektronik.de