



LI-7500 RS

Open Path CO₂/H₂O
Gas Analyzer

Instruction Manual

LI-COR[®]

LI-7500RS

Open Path CO₂/H₂O Gas Analyzer

LI-COR Biosciences

Global Headquarters

4647 Superior Street
Lincoln, Nebraska 68504
Phone: +1-402-467-3576 • Toll free: 800-447-3576 • Fax: +1-402-467-2819
envsales@licor.com • envsupport@licor.com • www.licor.com/env

Regional Offices

LI-COR GmbH, Germany

Serving Andorra, Albania, Cyprus, Estonia, Germany, Iceland, Latvia, Lithuania, Liechtenstein, Malta, Moldova, Monaco, San Marino, Ukraine, and Vatican City.
LI-COR Biosciences GmbH
Siemensstraße 25A • 61352 Bad Homburg
Germany
Phone: +49 (0) 6172 17 17 771 • Fax: +49 (0) 6172 17 17 799
envsales-gmbh@licor.com • envsupport-gmbh@licor.com

LI-COR Ltd., United Kingdom

Serving Denmark, Finland, Ireland, Norway, Sweden, and UK.
LI-COR Biosciences UK Ltd.
St. John's Innovation Centre
Cowley Road • Cambridge • CB4 0WS
United Kingdom
Phone: +44 (0) 1223 422102 • Fax: +44 (0) 1223 422105
envsales-UK@licor.com • envsupport-UK@licor.com

LI-COR Distributor Network:

www.licor.com/env/distributors

The LI-COR logo is displayed in a bold, italicized, sans-serif font. The letters 'LI-COR' are in a dark grey or black color, with a registered trademark symbol (®) at the end.

NOTICE

The information contained in this document is subject to change without notice.

LI-COR MAKES NO WARRANTY OF ANY KIND WITH REGARD TO THIS MATERIAL, INCLUDING, BUT NOT LIMITED TO THE IMPLIED WARRANTIES OF MERCHANTABILITY AND FITNESS FOR A PARTICULAR PURPOSE. LI-COR shall not be liable for errors contained herein or for incidental or consequential damages in connection with the furnishing, performance, or use of this material.

This document contains proprietary information which is protected by copyright. All rights are reserved. No part of this document may be photocopied, reproduced, or translated to another language without prior written consent of LI-COR, Inc.

The LI-7500RS is covered by U.S. patents 6,317,212; 9,121,793, and foreign equivalents. Other patents pending.

EddyPro® Software and the SMARTFlux System are trademarks of LI-COR, Inc. Microsoft® and Windows® are registered trademarks of Microsoft Corporation. Eurofast® is a registered trademark of Turck, Inc. Campbell Scientific® is a registered trademark of Campbell Scientific, Inc. Dropbox and the Dropbox logo are trademarks of Dropbox, Inc. All other trademarks or registered trademarks are property of their respective owners.

Printing History

Publication Number 984-15811

© Copyright 2015, LI-COR, Inc.

New editions of this manual will incorporate all material since the previous editions. Update packages may be used between editions which contain replacement and additional pages to be merged into the manual by the user. The manual printing date indicates its current edition. The printing date changes when a new edition is printed. (Minor corrections and updates which are incorporated at reprint do not cause the date to change).

Version Number	Publication Date	Changes
1st Printing	November, 2015	Not applicable.

Updated on Wednesday, January 20, 2016.

LI-7500						
Material Composition or Impurity						
Component Name	Lead (Pb)	Mercury (Hg)	Cadmium (Cd)	Chromium VI Compounds (Cr ^{VI})	Polychlorinated Biphenyls (PCBs)	Polycyclic Aromatic Hydrocarbons (PAHs)
Lead (Pb)	0.0001	0.0001	0.0001	0.0001	0.0001	0.0001
Mercury (Hg)	0.0001	0.0001	0.0001	0.0001	0.0001	0.0001
Cadmium (Cd)	0.0001	0.0001	0.0001	0.0001	0.0001	0.0001
Chromium VI Compounds (Cr ^{VI})	0.0001	0.0001	0.0001	0.0001	0.0001	0.0001
Polychlorinated Biphenyls (PCBs)	0.0001	0.0001	0.0001	0.0001	0.0001	0.0001
Polycyclic Aromatic Hydrocarbons (PAHs)	0.0001	0.0001	0.0001	0.0001	0.0001	0.0001
2. The component does not contain the hazardous substance above the maximum concentration values in homogeneous mixture specified in the EU's REACH 2006 regulatory annexes for the RoHS.						
3. The component does contain the hazardous substance above the maximum concentration values in homogeneous mixture specified in the EU's REACH 2006 regulatory annexes for the RoHS.						
LI-7500 11-001-CO2/H2O 11-010						
11-001-CO2/H2O 11-010						
Component Name	Lead (Pb)	Mercury (Hg)	Cadmium (Cd)	Chromium VI Compounds (Cr ^{VI})	Polychlorinated Biphenyls (PCBs)	Polycyclic Aromatic Hydrocarbons (PAHs)
Lead (Pb)	0.0001	0.0001	0.0001	0.0001	0.0001	0.0001
Mercury (Hg)	0.0001	0.0001	0.0001	0.0001	0.0001	0.0001
Cadmium (Cd)	0.0001	0.0001	0.0001	0.0001	0.0001	0.0001
Chromium VI Compounds (Cr ^{VI})	0.0001	0.0001	0.0001	0.0001	0.0001	0.0001
Polychlorinated Biphenyls (PCBs)	0.0001	0.0001	0.0001	0.0001	0.0001	0.0001
Polycyclic Aromatic Hydrocarbons (PAHs)	0.0001	0.0001	0.0001	0.0001	0.0001	0.0001
4. The component does not contain the hazardous substance above the maximum concentration values in homogeneous mixture specified in the EU's REACH 2006 regulatory annexes for the RoHS.						
5. The component does contain the hazardous substance above the maximum concentration values in homogeneous mixture specified in the EU's REACH 2006 regulatory annexes for the RoHS.						

CE Marking

This product is a CE-marked product. For conformity information, contact LI-COR Support at envsupport@licor.com. Outside of the U.S., contact your local sales office or distributor.

A bit of history...

The LI-7500RS model is the followup to the LI-7500A, and the LI-7500 before that. Developed initially to be a component of homemade eddy covariance systems, the LI-7500 was the first open path gas analyzer to find widespread use in eddy covariance measurements. The LI-7500A brought datalogging, networking capabilities, and a number of improvements to the measurement, but most significantly, it grew into the core component of a stand-alone, full featured eddy covariance system.

The RS models present improvements to the optical hardware, and these improvements will directly affect the quality of data collected and the cleaning frequency of optical components.

New instruments will provide a noticeable difference in measurements in many circumstances. Older instruments can be upgraded to the new hardware. If you don't want to purchase the upgrade, you can still update your instrument software to the most current version—so you are not left behind by the new model number.

Even if you do not upgrade your instrument hardware, you can use this manual to guide your use of an original LI-7500A. We invite you to install the new software on older instruments. It is available for free from the LI-COR web site. We also invite your feedback—what do you like? What do you dislike? What do you want to measure that you can't measure now?

Contents

A bit of history...	iv
---------------------	----

Section 1. General Information

What's What	1-2
Spare Parts Kits	1-2
Cables	1-3
Air Temperature Sensor	1-4
Calibration Certificate	1-5
LI-7550 Analyzer Interface Unit	1-6

Section 2. Initial Setup

Getting Started Tutorial	2-1
Installing the LI-7500RS and Components	2-4
Mounting the LI-7550 Analyzer Interface Unit	2-4
Mounting the Sensor Head	2-5
Connecting the Sensor Head Cable	2-6
Tips for Successful Use of the LI-7500RS	2-7
Dew	2-7
Rain and Snow	2-7
Dust, Pollen, and Salt Deposits	2-8
Vibrations	2-8
Using the 7550-101 Auxiliary Sensor Interface	2-9
Mounting the ASI	2-9
Terminal Connections	2-10
Electrical Connections	2-11
Connecting Sensors to the ASI	2-11

Section 3. Operation

Installing the PC Software	3-1
Connecting with the Analyzer	3-1
Connect over Ethernet	3-1
Connect over Serial RS-232	3-3
Run Disconnected	3-4
Dashboard	3-5
Instrument Information	3-6

IRGA Status and Connectivity	3-7
Eddy Covariance Flux Graphs	3-8
Data Display	3-10
Configuring Eddy Covariance Measurements	3-13
Eddy Covariance Checklist	3-14
System Clock	3-16
Configuring the USB Log File	3-17
Entering the Site Description	3-18
Entering Anemometer Information	3-20
Entering CO ₂ /H ₂ O Analyzer Information	3-27
Entering LI-7700 Information	3-30
Entering Biomet System Information	3-33
Connecting with the SmartFlux System	3-35
Begin Logging Data	3-36
Transferring Logged Data	3-39
Running SmartFlux	3-41
Express Processing	3-41
Overview of Advanced Processing	3-42
SmartFlux Results Files	3-52

Section 4. Calibration

How Stable are Zero and Span?	4-1
Checking the Zero	4-2
Checking the Span	4-3
Step-by-Step Calibration Instructions	4-5
Considerations for Setting the Secondary Span	4-8
Step-by-Step Secondary CO ₂ Span	4-8
Step-by-Step Secondary H ₂ O Span	4-9
What Actually Happens	4-9

Section 5. Maintenance

Schedule	5-1
Cleaning the Optical Path	5-2
Replacing the Fuses	5-3
Power Supply Fuse	5-3
Accessory Fuse	5-4
Replacing the Internal Chemicals	5-4

Section 6. Troubleshooting

Power On Problems	6-1
Ethernet Connection Problems	6-1
RS-232 serial connection problems	6-2
Bad Temperature Readings	6-3
Bad Pressure Readings	6-4
Bad CO2 or H2O Readings	6-4

Section 7. Software Reference

Settings	7-1
Time	7-1
Network	7-4
Manual	7-7
Advanced—Chopper Housing Temperature	7-7
Integration	7-8
LI-7500RS Menu Overview	7-10
Auxiliary Inputs	7-10
Outputs	7-12
Calibration Overview	7-21
Changing Sensor Heads	7-24
Diagnostic Messages	7-25
General indicators	7-25
Test Point Values	7-26
Waveform	7-29
Charting	7-30
PC Logging	7-32
Configuration Files	7-33
Software Updates	7-33
Embedded Instrument Software	7-34
PC Software Update	7-35

Section 8. Theory of Operation

Relating Absorption to Concentration	8-1
Measuring Absorptance	8-2
Cross Sensitivity	8-3
Zero Drift	8-3
Equation Summary	8-4

H2O	8-4
CO2	8-4
LI-7500RS Implementation	8-6
A Note About Pressure And Temperature	8-7
LI-7500RS Diagnostics	8-7
CO2 Signal Strength	8-7

Appendix A. Specifications

Appendix B. Pin Assignments

Appendix C. Suppliers

Appendix D. Configuration Grammar

Appendix E. Warranty

Index

Section 1. General Information

The LI-7500RS is a high performance, non-dispersive, open path infrared CO₂/H₂O analyzer designed for use in eddy covariance flux measurement systems. Some of its important features include:

- Simultaneous, high-speed measurements of CO₂ and H₂O in the free atmosphere (150 Hz measurements) are digitally filtered to provide true 5, 10, or 20 Hz bandwidth.
- Logging complete eddy covariance data sets.
- Onboard computation of flux data in the SMARTFlux System, which is included as a standard component.

The LI-7500RS is designed for eddy covariance flux measurements, but it is also suitable for profile measurements, relaxed eddy accumulation measurements, gradient flux techniques, or any other application that depends on high-speed CO₂ gas or water vapor measurements.

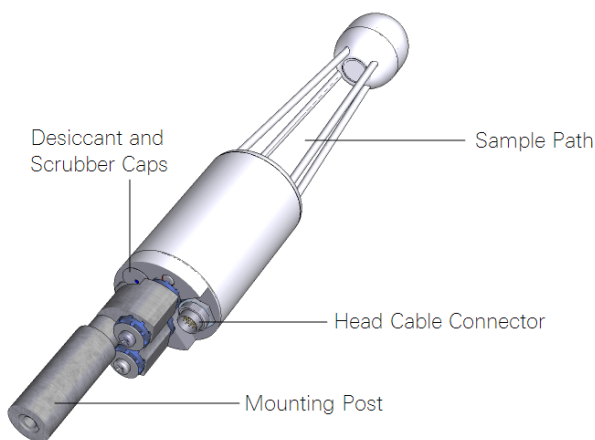

Figure 1-1. Components of the LI-7500RS sensor head.

Note: LI-COR, Inc. does not endorse the use of the LI-7500RS on moving platforms or in applications where the instrument is exposed to corrosive elements (i.e., oceanographic salt water spray). If you have questions about the suitability of the instrument for your application, please contact LI-COR.

What's What

If you have just taken delivery of your LI-7500RS, check the packing list to verify that you have received everything that was ordered.

Note: You need the PC software to configure the instrument. Download it from the LI-COR technical support web site: www.licor.com/env/support. Select your instrument and you'll find the software downloads.

Spare Parts Kits

This LI-7500RS sensor head spare parts kit (part number 7500-028) includes accessories and replacement parts for the sensor head. The LI-7550 Analyzer Interface Unit also has a spare parts kit (part number 9975-023). It includes the cables and mounting bracket. As you become familiar with the analyzer you will learn which items to keep close at hand and which items can be stored away.

Description	Qty.	Part Number
LI-7500RS Spares Kit	1	7500-028
Bev-a-line Tubing (15 feet; 4.6 meters)	1	222-01824
Sensor Head Mounting Post (blue dampers)	1	9975-010
Calibration Accessory	1	9975-024
Calibration Accessory Gaskets	1	9975-014
Air Temperature Sensor	1	9975-026
LI-7550 Analyzer Interface Unit Spares Kit	1	9975-023
Control Unit Mounting Kit	1	9979-022
RS-232 Cable	1	392-10268
Power Cable	1	9975-030
Analog Input/Output Cable	1	392-10109
Ethernet Cable	1	392-10108
Ethernet Adapter Cable	1	392-10107
SDM Interface Cable	1	392-10093
5 Amp Fuse	2	439-04214
16 GB USB Flash Drive	1	616-10723
(Optional) Auxiliary Sensor Interface Spares Kit	1	9975-032

Description	Qty.	Part Number
U-Bolt, 1/4 x 20	2	184-09842
Hex Nut	4	163-00138
Santoprene (1/16" inside diameter; 2 feet; 0.6 meters)	1	22-08325
Quick Connect Plug	10	0300-07393

Cables

Cables are 5 meters long. The sensor head cable can be extended to 10 meters. The other cables can be ordered in custom lengths from the supplier (see *Cables* on page C-2) or homemade (see *Figure 1-4* on page 1-7 for wire assignments).

Power Cable

Part number 9975-030. Connects to the **POWER** terminal on the analyzer interface unit connector panel. The power cable is terminated with black (VIN-) and red (VIN+) wires for connection to a user-supplied 10.5-30 VDC power supply (3 A or greater).

Sensor Head Cable

Part number 392-13984. Connects the sensor head to the LI-7550 Analyzer Interface Unit.

A 5-meter extension (part number 392-13984) can be connected to extend the distance between the sensor head and the LI-7550 Analyzer Interface Unit to 10 meters. Only one extension cable can be used.

Ethernet Cables

Two Ethernet cables are included for connection to a Local Area Network (LAN) or directly to a computer. Part number 392-10108 is a 5-meter cable terminated on both ends with a male Turck connector; one end plugs into the LI-7550 Analyzer Interface Unit, and the other end plugs into the Ethernet Adapter Cable. Part number 392-10107 is a short Ethernet adapter cable that is terminated with an RJ-45 connector, and is used to connect the 5-meter Ethernet cable to an Ethernet wall socket or into your computer's Ethernet port.

RS-232 Serial Cable

This 5-meter null modem cable has a 6-pin female circular connector that plugs into the **RS-232** connector on the LI-7550 Analyzer Interface Unit. The other end has a standard DB-9 female connector for direct connection to a computer. Most modern computers will require an RS-232-to-USB adapter to use this cable.

SDM Cable

Part number 392-10093, for connecting to Campbell Scientific®, Inc.(Logan, UT) dataloggers for Synchronous Device for Measurement (SDM) communications. For more information on using this instruction refer to *SDM Output (LI-7500RS SDM Output* on page 7-15) and the instruction manual for your datalogger. The SDM cable connects to the connector labeled **SDM** on the Analyzer Interface Unit connector panel.

Analog Input and Output Cable

Part number 392-10109. Used to connect external sensors to LI-7550 analog inputs; or for analog outputs.

When used with external input devices, this cable plugs into the connector labeled **AUXILIARY INPUT** on the LI-7550 Analyzer Interface Unit connector panel. When used for outputs, the cable plugs into the connector labeled **DAC OUTPUT** on the LI-7550 Analyzer Interface Unit. If you intend to use both the Auxiliary Input and DAC Output ports on the LI-7550, you will need the 7550-101 Auxiliary Sensor Interface, a Sonic Anemometer Cable, or an additional 392-10109 cable.

Sonic Anemometer Cables

Optional cables to connect a sonic anemometer signals to the LI-7550 analog inputs.

- **Gill WindMaster™/Pro**: Part number 9975-033
- **Gill R3™/HS-50™**: Part number 9975-041
- **CSAT3**: Part number 9975-035

Air Temperature Sensor

Part number 9975-026. An air temperature thermistor is included for measuring ambient temperature outside of the LI-7550 Analyzer Interface Unit.

Calibration Certificate

Provides the calibration coefficients for your sensor head. These values are unique to each sensor head and have been entered into the corresponding LI-7550 at the factory. Keep this sheet in case you need to re-enter these values. You can also acquire a copy of your calibration certificate from the LI-COR support web site.

LI-7550 Analyzer Interface Unit

The LI-7550 Analyzer Interface Unit houses the gas analyzer electronics and a connector for the USB flash drive. A 16 GB industrial-rated drive is included with the instrument. There are three Ethernet connectors inside the LI-7550, two of which are connected to the external ports. The third is connected to the SMARTFlux System.

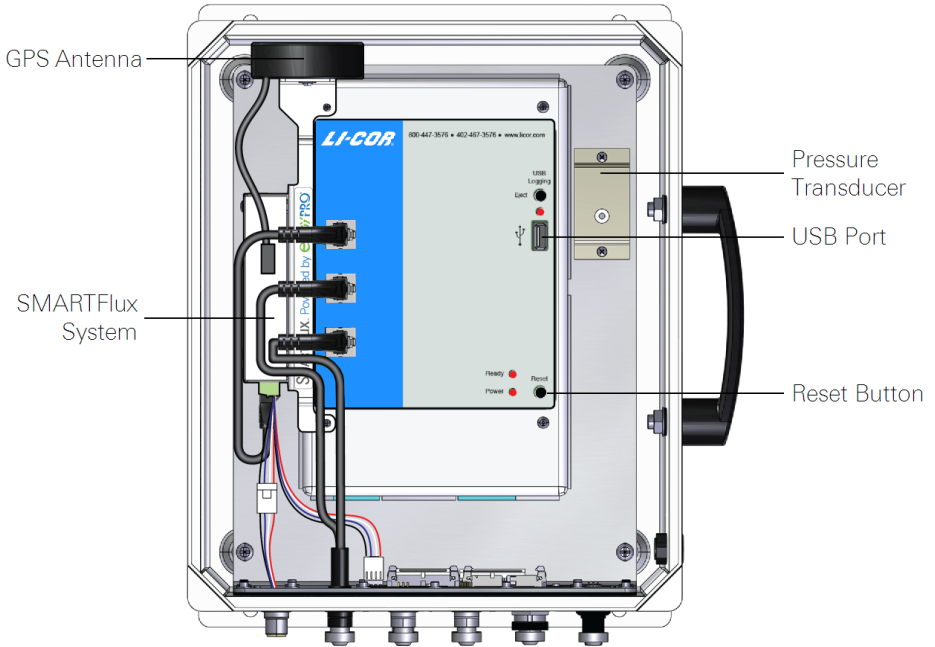

Figure 1-2. LI-7550 interior.

Note: Only use an industrial rated USB flash drive. Standard flash drives can fail, causing you to lose data.

The connection panel has connectors for the sensor head and other cables.

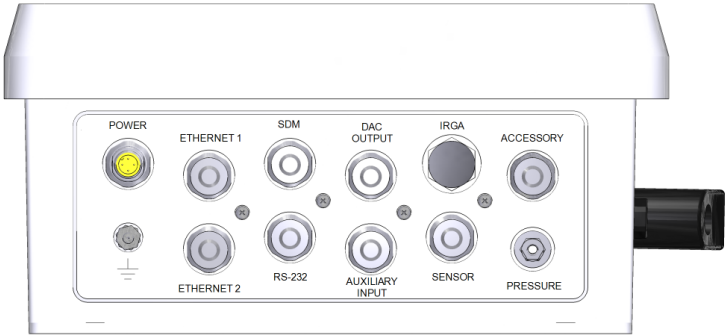

Figure 1-3. LI-7550 connector panel.

LI-7550 Pin Assignments											
SDM			ANALOG IN				ANALOG OUT				
PIN 1	BROWN	SDM_EN	PIN 1	WHITE	AUX1+	PIN 1	WHITE	DAC1			
PIN 2	WHITE	SDM_CLK	PIN 2	BROWN	AUX1-	PIN 2	BROWN	DAC2			
PIN 3	BLUE	SDM_DATA	PIN 3	GREEN	AUX2+	PIN 3	GREEN	DAC3			
PIN 4	BLACK	GND	PIN 4	YELLOW	AUX2-	PIN 4	YELLOW	DAC4			
COUPLING	BARE	EARTH GND	PIN 5	GREY	AUX3+	PIN 5	GREY	DAC5			
POWER			PIN 6	PINK	AUX3-	PIN 6	PINK	DAC6			
PIN 1	BROWN —BLACK	VIN-	PIN 7	BLUE	AUX4+	PIN 7	BLUE	READY			
PIN 2	WHITE /	VIN-	PIN 8	RED	AUX4-	PIN 8	RED	NC			
PIN 3	BLUE /	VIN+	PIN 9	ORANGE	+5V	PIN 9	ORANGE	NC			
PIN 4	BLACK /	VIN+	PIN 10	TAN	GND	PIN 10	TAN	GND			
INPUT: 10 - 30VDC			PIN 11	BLACK	GND	PIN 11	BLACK	GND			
FUSE: 5A F 125/250V			PIN 12	VIOLET	GND	PIN 12	VIOLET	GND			
USB LOGGING - USE INDUSTRIAL GRADE ONLY! <ul style="list-style-type: none"> ● SOLID LED - DRIVE MOUNTED, NOT LOGGING ●●● RAPID BLINK - LOGGING ●● SLOW BLINK - ERROR, EJECT AND RETRY ○ NO LED - DRIVE NOT MOUNTED, OK TO REMOVE <p>WARNING! FAILURE TO PRESS EJECT BUTTON BEFORE REMOVING USB DRIVE WILL RESULT IN LOSS OF DATA!</p>				<p>LI-COR Biosciences 4947 Superior St. Lincoln, NE 68504 1-800-447-3576 (U.S. & Canada) 402-467-3576 FAX: 402-467-2819 envsales@licor.com ● envsupport@licor.com www.licor.com</p>							

Figure 1-4. Pin assignments and wire colors for Power, SDM, Auxiliary Input and DAC Output cables. The lower left section describes indicators given by the USB indicator light.

Section 2. Initial Setup

This section describes how to mount the analyzer and accessories in a typical eddy covariance application.

Getting Started Tutorial

The following section briefly covers the basic steps you might follow to set up the LI-7500RS to collect and record data. Many of these steps are described in greater detail elsewhere in this manual.

1 Connect Head Cable to the Analyzer Head
Align the notches on the cable connectors, then push in and turn the connector clockwise to tighten it. After it gets tight, turn it an additional $\frac{1}{2}$ turn to ensure a watertight seal.

2 Install the Temperature Sensor
The temperature sensor attaches to the LI-7550 connector labeled **SENSOR**.



3 Connect the Head Cable to the LI-7550
It attaches to the connector labeled **IRGA**.

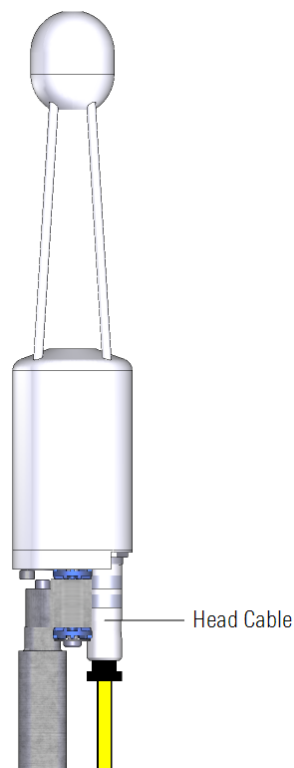

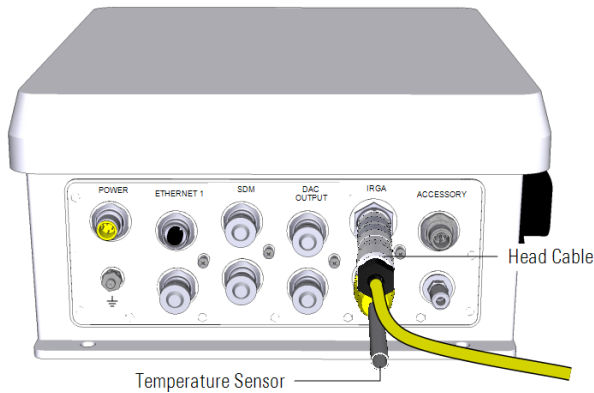
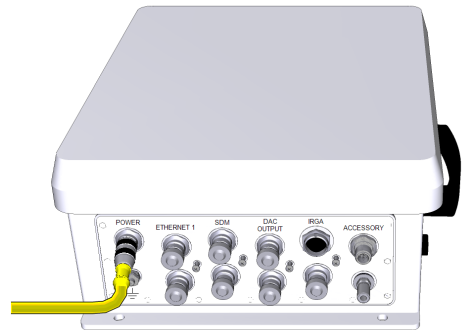

Figure 2-1. Attach the head cable and temperature sensor.

4 Power On the Analyzer

The power cable (part number 9975-030) attaches to the LI-7550 at the location marked **POWER**. The other end has bare wire leads for connection to a 10.5-30 VDC supply (3 A or greater). Connect the red lead to the positive terminal of the power supply, and the black wire to the negative terminal.



5 Connect the Ethernet Cable

Connect the Ethernet and extension cable to the LI-7550 front panel. Plug the RJ45 connector into your computer or a network jack.

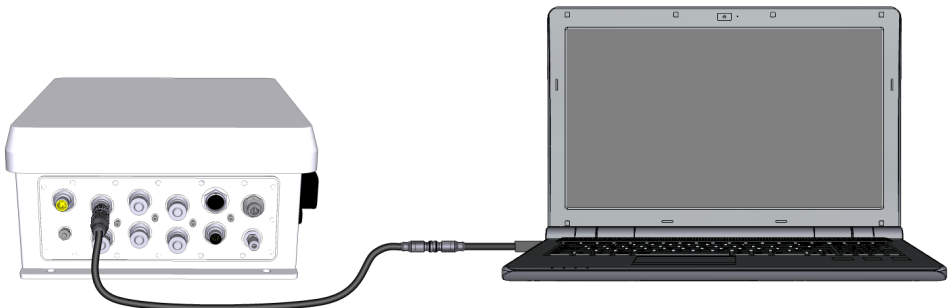

6 Install the PC Software

Go to www.licor.com/env/support, select your instrument and then select Software. Download the software and install it on your computer. The program icon will be in the Programs menu under the LI-COR folder.

7 Connect with the Instrument

Launch the PC software, then select your instrument from the list and click **Connect**.

8 Verify the Instrument Response

If the instrument is indoors it will probably have very high CO₂ readings. Exhale through the sample path. You should see a sudden spike in the CO₂ and H₂O readings.

9 Configure Site Setup

For eddy covariance measurements using EddyPro® Software or the SMARTFlux System, configure the site setup (see *Configuring Eddy Covariance Measurements* on page 3-13).

Installing the LI-7500RS and Components

The LI-7500RS is typically installed on a tripod or tower for eddy covariance applications. This section describes how to install the instrument and its associated components.

Mounting the LI-7550 Analyzer Interface Unit

The mounting kit (part number 9979-022) is used to mount the LI-7550 to a tripod or other post. You can also attach the box directly to a flat surface. The LI-7550 will operate according to specifications in direct sun.

Determine the height at which the sensor head will be mounted, and plan to mount the Analyzer Interface Unit accordingly. The head cable is 5 meters long. An extension cable can extend the total cable length to a maximum of 10 meters.

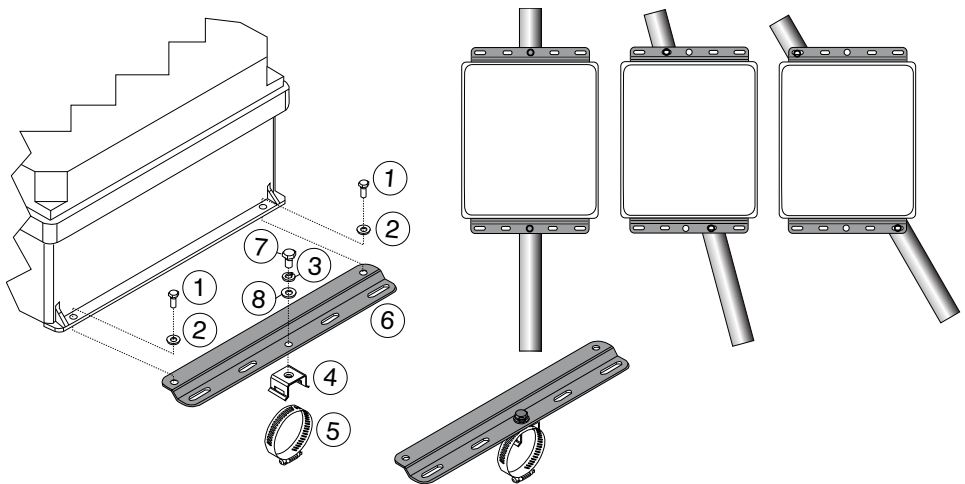

Figure 2-2. Attach mounting plates to Analyzer Interface Unit, attach band clamp mounting brackets to mounting plates, and secure to mounting post using band clamps.

Table 2-1. Mounting kit parts.

Item	Qty.	Part Number	Description
1	4	150-12943	M6x1 × 16 MM Hex Head Bolt
2	4	167-02054	Flat Washer 1/4 × 5/8"
3	2	167-05635	Split Washer 5/16"

Table 2-1. Mounting kit parts. (...continued)

Item	Qty.	Part Number	Description
4	2	235-13234	Single Bolt Flared Leg Mounting Bracket
5	2	300-13293	Hose Clamp, 9/16"
6	2	9879-045	Mounting Plate
7	2	included w/ item #4	5/16-24 × 1/2" Hex Head Bolt
8	2	included w/ item #4	5/16" Flat Washer

Mounting the Sensor Head

The LI-7500RS sensor head should be mounted to a tripod or tower using the mounting kit (part number 7900-340) or a 3/4 inch IPS NuRail® swivel mount. The head should be tilted at a 15° angle to ensure water does not pool on the lower lens.

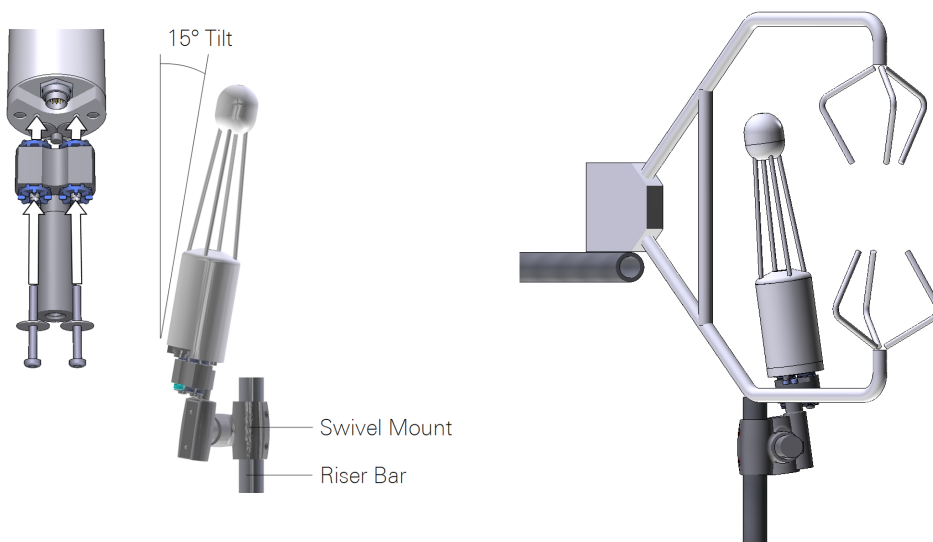

Figure 2-3. Mount the sensor head near the sonic anemometer, at a 15° angle. Position the analyzer to minimize disruption of wind-flow near the sonic anemometer.

The sensor head should be placed as close to the sonic anemometer as possible, with the center of the analyzer and sonic anemometer at equal heights, as shown in *Figure 2-3* above

Connecting the Sensor Head Cable

It is important that the head cable be connected properly to the analyzer sensor head. Follow these guidelines to ensure a good connection and proper strain relief to increase the life of the cable(s):

- There is a gasket in the head cable connector. When tightening the connector, wiggle and push the connector while tightening to compress the gasket.
- Provide a loose bend radius to allow the cable to absorb the energy of the bending over a greater portion of its length. Use a minimum bend radius of 5 times the cable diameter. For the head cable, this is a 1.75" (4.5 cm) minimum bend radius (or 3.5" (9 cm) minimum loop width).
- When tying cables with cable ties, leave the ties loose enough for the cables to slide freely under the tie. Never over tighten the tie to the point where the cable jacket becomes pinched.

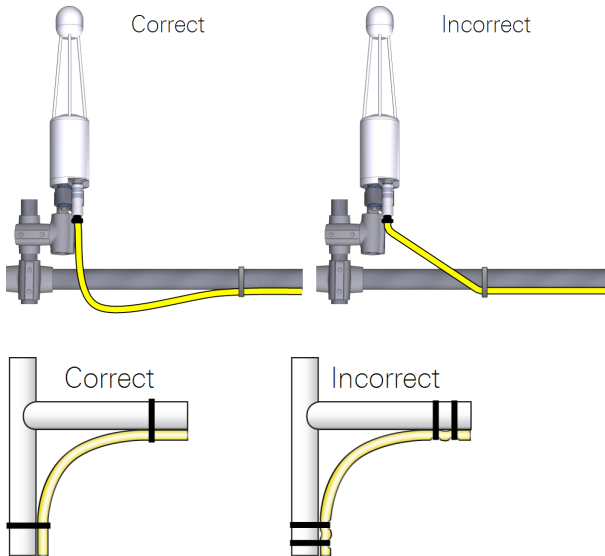

Tips for Successful Use of the LI-7500RS

Dew

The LI-7500RS can tolerate droplets on the windows to a certain extent. The automatic gain control will increase, but the calibration is unchanged. If the droplets coalesce and get big enough, the CO₂ Signal Strength will approach 0, and eventually the readings will become unusable. This can be minimized by tilting the sensor head 10 to 15° from vertical and by applying a water-shedding coating such as RainX® to the lower window.

Rain and Snow

Raindrops and snowflakes in the optical path will affect the performance of the LI-7500RS, even if the total light blockage does not drive the CO₂ Signal Strength close to 0. The reason is that the droplets and flakes are moving, and if one is in the path for a sample measurement, but out of the path for a reference measurement (or vice versa), it will influence the reading. *Figure 2-4* below is data taken during a light snow shower. The spikes are due to blockage changes between sample and reference readings. Notice that in some cases both CO₂ and H₂O are affected, and sometimes just one. Also, the spikes are equally likely to be up or down.

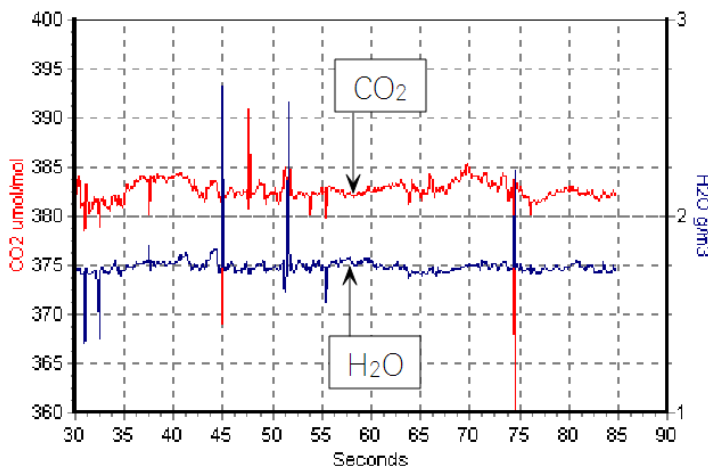

Figure 2-4. Small spikes may be evident when raindrops and snowflakes pass through the optical path.

The higher the bandwidth, the more pronounced this effect, since less averaging is done.

Dust, Pollen, and Salt Deposits

The LI-7500RS is quite tolerant of particulates on the windows, as long as they are small, and spectrally neutral. Pollen and salt deposits may become a problem because they are sticky and can accumulate, so monitor the CO₂ Signal Strength value and clean the windows as needed.

Vibrations

The LI-7500RS is vibration sensitive to frequencies of 150 Hz \pm the bandwidth. Thus, if the bandwidth is 10 Hz, the frequency problem range is 140 to 160 Hz (and upper harmonics). The instrument is completely insensitive to vibrations slower than this, and very slightly sensitive at frequencies higher than this.

For land-based installations, probably the most likely source of vibrational problems would be on a tower with tight guy wires. For other settings (aircraft, ships, etc.) where there may be vibrations in the problem range, you should try to minimize the problem through alternative mounting attachments.

Using the 7550-101 Auxiliary Sensor Interface

The optional Auxiliary Sensor Interface (ASI) is a O-ring sealed, weatherproof junction box that can be used to connect analog inputs and/or outputs. It has connections for up to six analog outputs, four general purpose analog inputs, and a constant 5 VDC source (5 mA maximum).

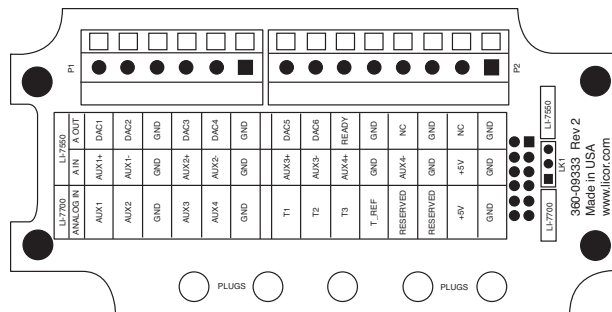

Figure 2-5. Interior label of the ASI.

The ASI can also be configured to work with the LI-7700 Open Path CH₄ Analyzer. There is a small jumper located at position LK1 (far right in Figure 2-5 above). When using the ASI with the LI-7500RS, make sure that the jumper is positioned over the 2 pins nearest the LI-7550 label (the topmost 2 pins).

Mounting the ASI

The ASI mounting bracket can be attached to a 1 to 1½" (2.5 to 4 cm) post. Two U-bolts and hex nuts are included for this purpose. It can be mounted either vertically or horizontally, but to prevent leaks, orient the plugs so they face the ground. If you do not want to use the mounting plate, remove the two screws that hold the mounting bracket and secure it however you want.

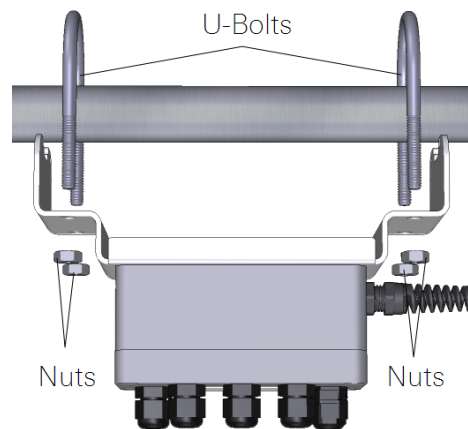





























Figure 2-6. Orient the gland plugs toward the ground to prevent water ingress.

Terminal Connections

Terminal positions for analog inputs are:

	Terminal	Analog Inputs ¹	Description
AUX1+ 	1	AUX1+	Auxiliary Input 1 positive
AUX1- 	2	AUX1-	Auxiliary Input 1 negative
GND 	3	GND	Ground
AUX2+ 	4	AUX2+	Auxiliary Input 2 positive
AUX2- 	5	AUX2-	Auxiliary Input 2 negative
GND 	6	GND	Ground
AUX3+ 	7	AUX3+	Auxiliary Input 3 positive
AUX3- 	8	AUX3-	Auxiliary Input 3 negative
AUX4+ 	9	AUX4+	Auxiliary Input 4 positive
GND 	10	GND	Ground
AUX4- 	11	AUX4-	Auxiliary Input 4 negative
GND 	12	GND	Ground
+5V 	13	+5V	+5V supply
GND 	14	GND	Ground

Terminal positions for analog outputs are:

	Terminal	Analog Outputs ²	Description
DAC1 	1	DAC1	DAC channel 1 positive
DAC2 	2	DAC2	DAC channel 2 positive
GND 	3	GND	Ground
DAC3 	4	DAC3	DAC channel 3 positive
DAC4 	5	DAC4	DAC channel 4 positive
GND 	6	GND	Ground
DAC5 	7	DAC5	DAC channel 5 positive
DAC6 	8	DAC6	DAC channel 6 positive
READY 	9	READY	Analyzer ready
GND 	10	GND	Ground
NC 	11	NC	No connection
GND 	12	GND	Ground
NC 	13	NC	No connection
GND 	14	GND	Ground

¹Analog Inputs $\pm 5V$

²Analog Outputs 0-5V

Electrical Connections

All analog devices connected to the ASI must be referenced to the ground (GND) connection; some examples are shown below.

- All LI-7500RS auxiliary analog input ground connections are internally connected together.
- All LI-7500RS auxiliary analog output ground connections are internally connected together.
- Analog devices with both ground and common outputs can share these outputs with their power supply ground.
- LI-7550 analog inputs are electrically isolated from the LI-7550 power input.
- LI-7550 analog outputs are electrically isolated from the LI-7550 power input and isolated from the analog inputs.

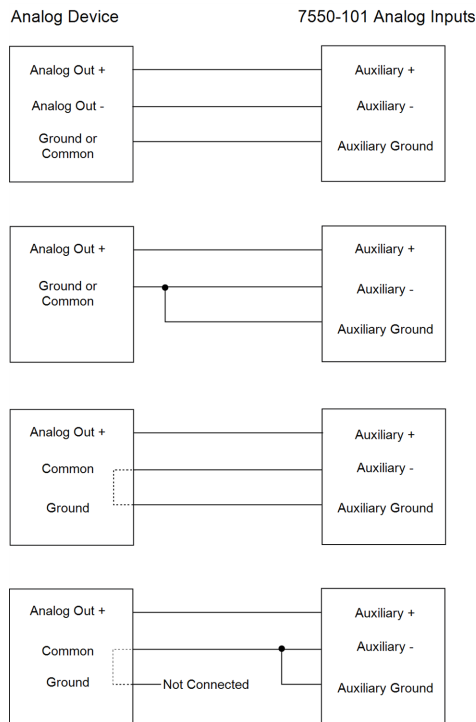

Connecting Sensors to the ASI

There are gland plugs on the ASI top cover, through which the sensor wires pass, after which they are connected to the appropriate screw terminals. Follow these steps to attach sensors or power to the ASI:

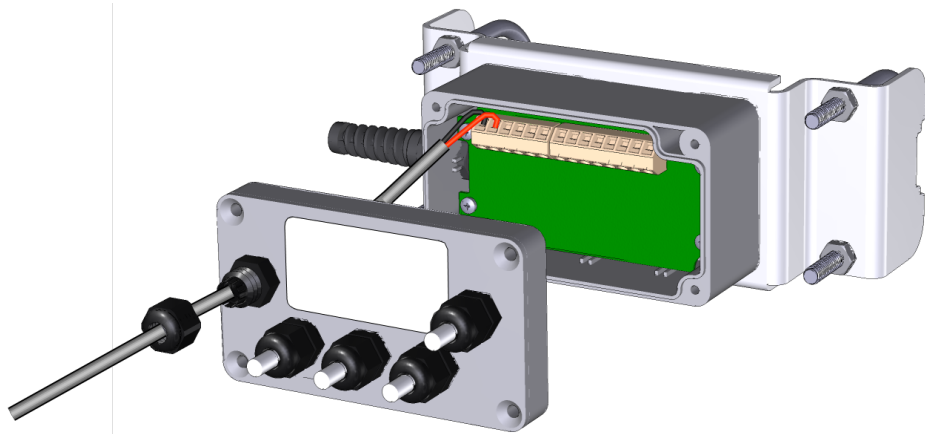

- 1.** Remove the Philips screws from the corners of the ASI and remove the top cover.
- 2.** Remove the cap from a gland plug.
- 3.** Pass the wires through the cap and then through the gland plug.
- 4.** Insert the wire leads into the appropriate terminals. Tighten the terminals to secure the wires. Make a note of which plug the wires are passing through (e.g., A, B, C), and to which terminals the wires are connected. This information will be needed when you enter the sensor calibration coefficients into software.
- 5.** Pull gently on the wires to remove excess wire from inside the interface. Re-attach the interface top cover and tighten the gland plug cap.
- 6.** Attach the ASI cable connector to the ANALOG IN connection on the Analyzer Interface Unit.

There are 5 EPDM type plugs inside the box that can be inserted into unused gland plugs. The plugs prevent water, insects, and dirt from entering the interface box. Remove the top cover and insert the narrow end of the plug through the back of the gland plug(s) and tighten the plug cap(s). The plugs should be used any time there are gland plugs that do not have wires inserted through them.

There is a length of Santoprene tubing in the ASI spares kit. This tubing can be cut to length and placed around small gauge wires that may not be able to be tightened sufficiently with the gland plug caps. It can also be used for oddly shaped wires that can be difficult to seal with the gland plug caps.

Section 3. Operation

This section describes how to configure your instrument for eddy covariance measurements. The LI-7500RS can be configured from any computer that is running Windows 10, 8/8.1, or 7. You can connect over Ethernet, USB with a USB-to-RS-232 adapter, or RS-232 serial.

Installing the PC Software

Go to www.licor.com/env/support, select your instrument and then select Software. Download the software and install it on your computer. The program icon will be in the Programs menu under the LI-COR folder.

Connecting with the Analyzer



Launch the software to open the **Connect** window. Here you set the parameters for communication between the instrument and your computer.

Connect over Ethernet

If the instrument is powered on and connected to an Ethernet port on the same subnet as your computer, its name will be displayed in the software. The default instrument name is the serial number of the Analyzer Interface Unit.

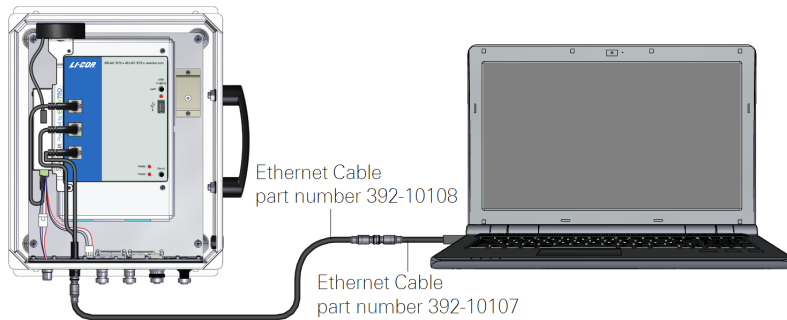
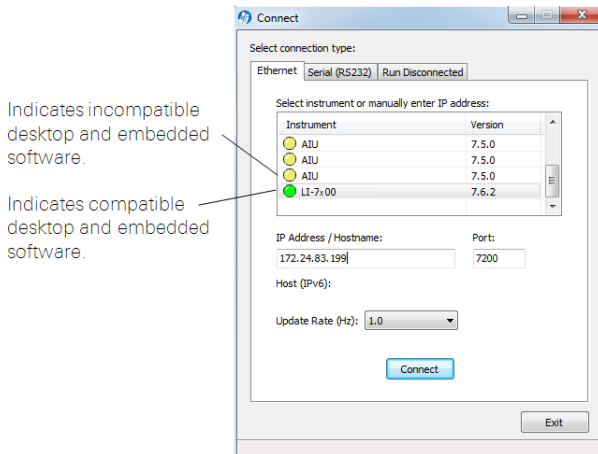

Figure 3-1. The Ethernet cable can plug directly into a computer or computer network.



- Yellow indicators show that the instrument embedded software is *incompatible* with the PC software. You can still connect, but there may be issues. See *Software Updates* on page 7-33.
- Green indicators show that the instrument embedded software is *compatible* with the PC software.

Note: We recommend that you always use the most up-to-date software and that your PC software and the instrument embedded firmware are compatible. Go to www.licor.com/env/support to get the latest instrument software.

The **Update Rate** is the communication frequency between the instrument and the computer. Select from 0.1, 0.2, 0.5, 1, 2, 5, 10, or 20 Hz.

Note: When connecting over satellite or cellular networks that have data limits, connect at a lower update rate (such as 0.1 Hz) to limit the amount of data used.

Click on the **Connect** button to establish communications with the LI-7500RS. If something is wrong, it will time out after about 15 seconds. If this happens, make sure you selected the correct instrument and retry.

Connect over Serial RS-232

The LI-7550 RS-232 port is configured as Data Terminal Equipment (DTE) with no hardware hand-shaking. It is bi-directional, meaning information can be transferred both into and out of the LI-7500RS.

Note: You may need a USB to RS-232 adapter to use the serial connection.

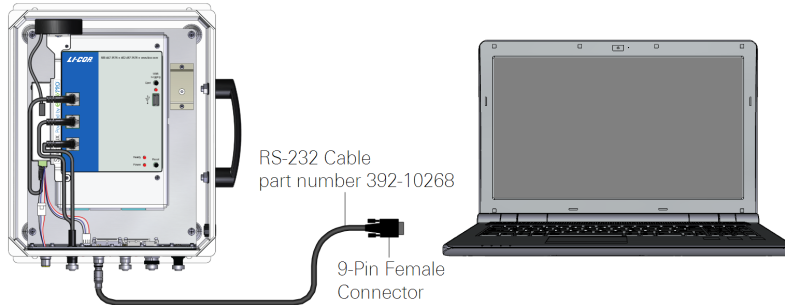

Select the communication baud rate for the serial port. The maximum update rate is dependent upon the rate available with your computer's serial port and the **Update Rate** used while the program communicates with the instrument. Select from 9600, 19200, 38400, 57600, or 115200.

The Update Rate is the communication frequency between the instrument and the computer. Select from 0.1, 0.2, 0.5, 1, 2, 5, 10, or 20 Hz. *Note that at 9600 baud, the maximum update frequency is 2 Hz; at 19200 baud, 5 Hz; at 38400 baud, 10 Hz; at 57600 baud, 15 Hz; and at 115200 baud, 20 Hz.*

Click the **Connect** button to establish communications with the LI-7500RS.

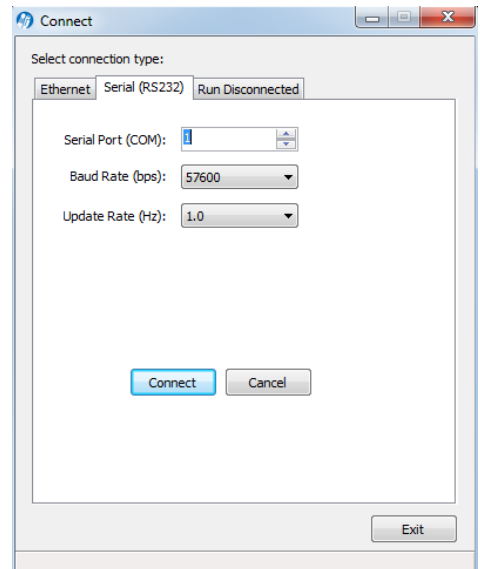

Run Disconnected

The PC software can be used independently of an instrument by clicking on the **Run Disconnected** tab and selecting the instrument. This can be useful for training purposes, or for creating a configuration file that can then be saved and transferred to instruments in the field. Much of the functionality of the software is disabled in this mode (e.g., data will not appear, so charting is unavailable), but features that do not require an active connection are fully functional.

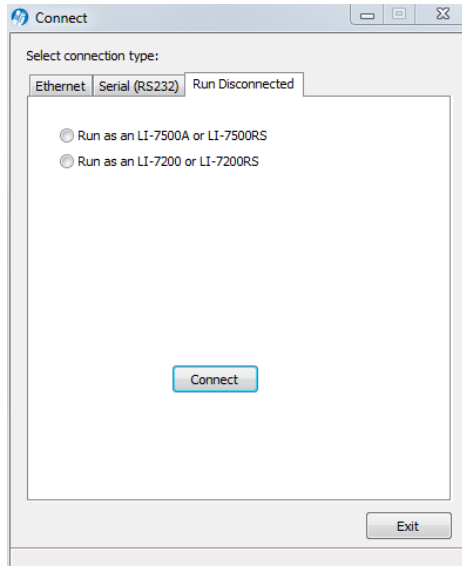

Dashboard

The dashboard presents settings to configure the LI-7500RS gas analyzer and eddy covariance datalogging¹ for EddyPro® Software. It provides status and diagnostic indicators, live data values, and graphs of fully corrected flux results from the SMARTFlux System.

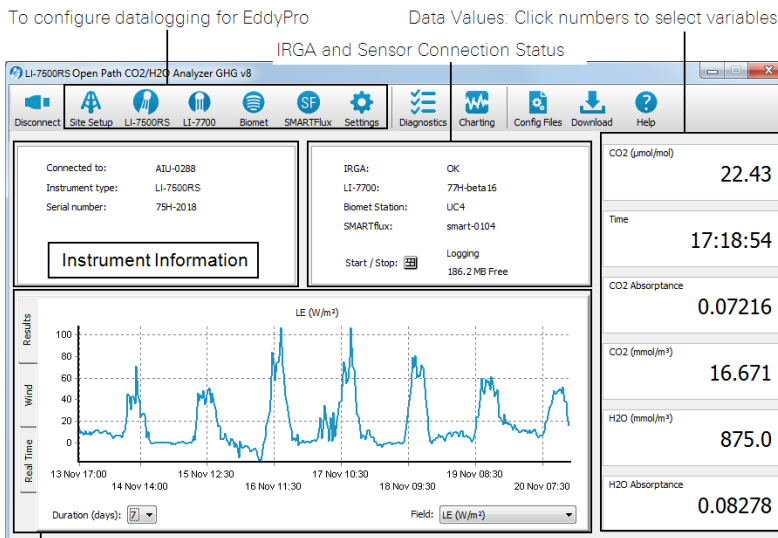

Graphing:

- Real Time data
- Results from the SMARTFlux® System
- Wind from the SMARTFlux® System

In addition, it is used to configure or connect with the system components:

- Sonic anemometer input settings
- LI-COR Biomet System
- LI-7700 Open Path CH₄ Analyzer
- SMARTFlux System eddy covariance computation module

¹.ghg files, which are logged by the LI-COR eddy covariance systems, are self-contained eddy covariance files that can be processed by EddyPro in the SMARTFlux System to provide fully corrected flux results.

Instrument Information

Information about the LI-7500RS is presented in this pane.

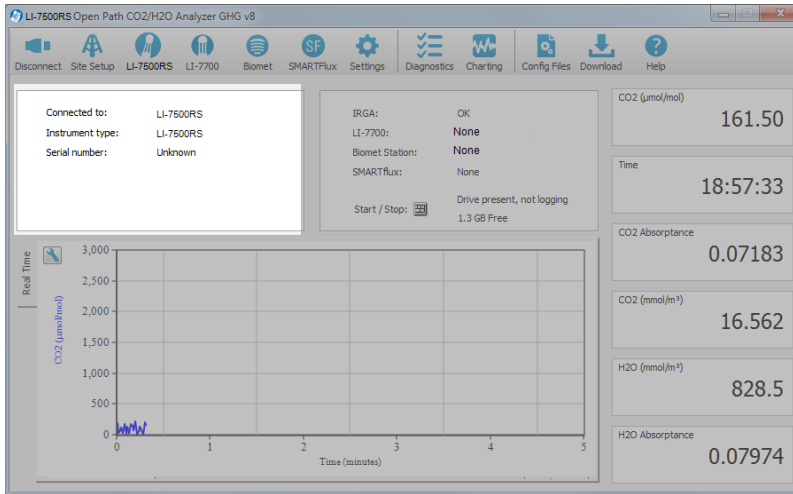

- **Connected to:** Indicates the network name of the gas analyzer.
- **Instrument type:** Indicates the model of the gas analyzer.
- **Serial number:** Serial number of the IRGA sensor head.

IRGA Status and Connectivity

Instrument status information is presented in the **status pane**.

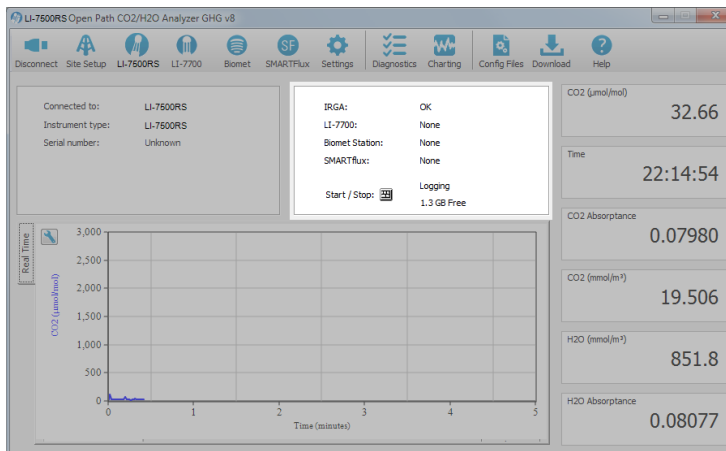

Note: The warning symbol () indicates that the component is in need of attention or that it is not communicating properly.

- **IRGA:** Indicates the status of the LI-7500RS CO₂/H₂O Analyzer.
- **LI-7700:** Indicates the status of the LI-7700 Open Path CH₄ Analyzer (optional).
 - **None:** LI-7700 not connected.
 - **Name of LI-7700:** Connected.
- **Biomet Station:** Indicates the status of the Biomet Station, if installed.
 - **None:** Biomet not connected.
 - **Name of Biomet System:** Connected.
- **SMARTFlux System:** Indicates the status of the SMARTFlux System.
 - **None:** SMARTFlux System not connected.
 - **Name of SMARTFlux System:** Connected.
- **Start/Stop:** Indicates USB drive presence and status.

Click the  graphic to open the datalogging window. See *Begin Logging Data* on page 3-36.

Eddy Covariance Flux Graphs

The graphing pane provides real-time graphing of measured variables, as well as eddy covariance flux results from the SMARTFlux System and a wind speed graph.

- **Real Time:** Current data measured by the instrument. Click the  button to open the charting dialog (see *Charting* on page 7-30).

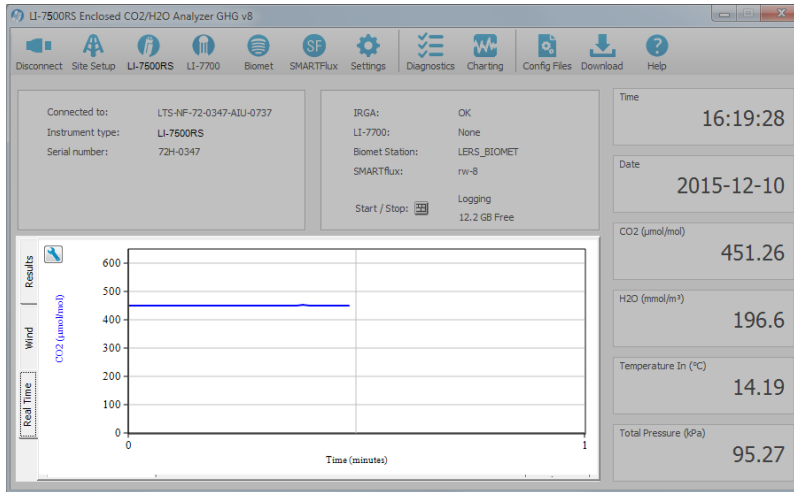

Note: It may take several minutes after you select a tab for data to load into the graph.

- **Results:** If the SMARTFlux System is properly configured, this tab presents fully corrected flux results for the variables that are measured at your site. **Duration** indicates the days of data that are displayed (maximum of 7 days). **Field** indicates the flux variable that is displayed. The variables available are:
 - H (W/m^2),
 - LE (W/m^2),
 - ET (mm/h),
 - CO₂ Flux ($\mu\text{mol}/m^2/s$),
 - CH₄ Flux ($\mu\text{mol}/m^2/s$; LI-7700 required),
 - u* (m/s),
 - CO₂ ($\mu\text{mol}/\text{mol}$),

- H₂O (mmol/mol),
- CH₄ (μmol/mol; LI-7700 required).

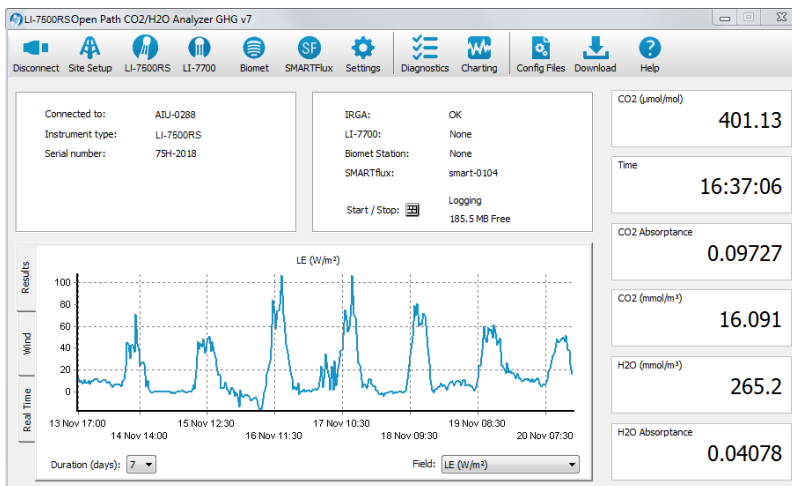

- **Wind speed:** If SMARTFlux System is properly configured, this tab presents wind speed means by direction. **Duration** indicates the days of data that are displayed.

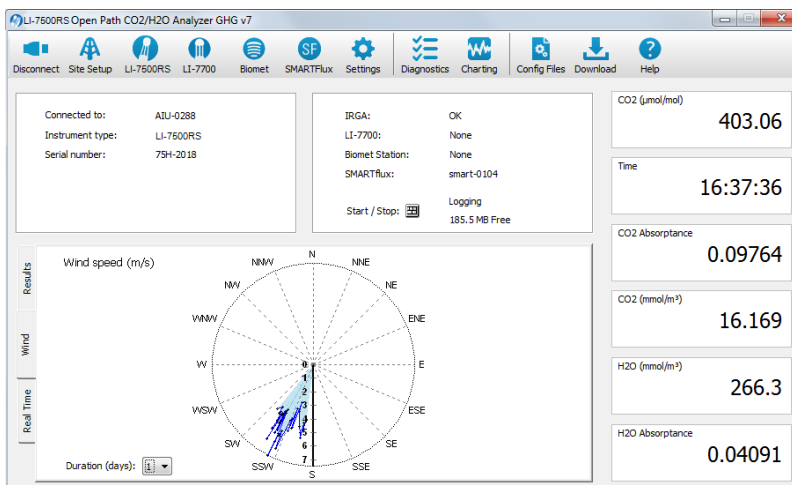

Data Display

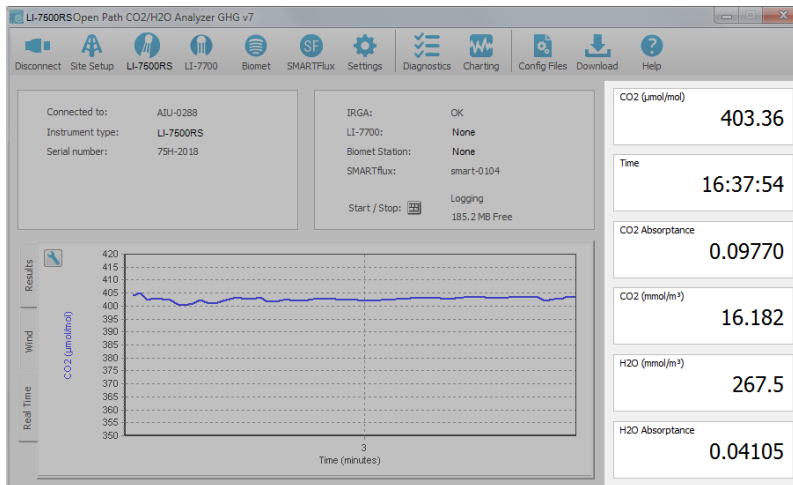

To change the variable(s) displayed in the data windows, click on the data value; a pop-up **Data Items** window appears (below), from which you can select the variable you want to display.

The variables available for display given in *Table 3-1* on the facing page.

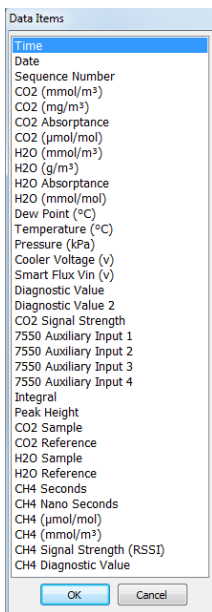
**Table 3-1.** Variables available for display and logging to the USB drive.

Variable	Description
Time	Time in HH:MM:SS:MS
Date	Date in YY:MM:DD
Sequence Number ¹	Index value, increments every 3.3 ms (1/300s)
CO ₂ (mmol/m ³)	CO ₂ concentration density
CO ₂ (mg/m ³)	CO ₂ mass density
CO ₂ Absorptance	CO ₂ raw absorptance value
CO ₂ (µmol/mol)	CO ₂ mole fraction
H ₂ O (mmol/m ³)	H ₂ O concentration density
H ₂ O (g/m ³)	H ₂ O mass density
H ₂ O Absorptance	H ₂ O raw absorptance value
H ₂ O (mmol/mol)	H ₂ O mole fraction
Dew Point (°C)	Dew point temperature (°C)
Temperature (°C)	Temperature measured at LI-7550
Pressure (kPa)	Pressure measured in LI-7550
Cooler Voltage (v)	Detector cooler voltage
SMARTFlux Vin (v)	Voltage in, SMARTFlux System required
Diagnostic Value	Diagnostic value 0-255
Diagnostic Value 2	Diagnostic value 0 or 1 (sync clocks) ²
CO ₂ Signal Strength	CO ₂ Signal Strength
7550 Auxiliary Input 1	Auxiliary input 1 value
7550 Auxiliary Input 2	Auxiliary input 2 value
7550 Auxiliary Input 3	Auxiliary input 3 value
7550 Auxiliary Input 4	Auxiliary input 4 value
Integral	Integration result (area under curve)
Peak Height	Integration peak height
CO ₂ Sample	Floating point value, power received from source in absorbing wavelength for CO ₂ (see 8-6)
CO ₂ Reference	Floating point value, power received from source in reference (non-absorbing) wavelength for CO ₂

¹Sequence number is displayed as **Ndx** (Index) in data output header

²A value of 0 indicates that the clocks in the LI-7550 and LI-7700 (if connected) are not synchronized, and/or the LI-7550 may not be logging data to the USB drive. A flag will appear next to 'LI-7700' in the dashboard in this state. A value of 1 indicates clocks are synchronized, and data are being logged to the USB drive.

Table 3-1. Variables available for display and logging to the USB drive.
(...continued)

Variable	Description
H2O Sample	Floating point value, power received from source in absorbing wavelength for H ₂ O
H2O Reference	Floating point value, power received from source in reference (non-absorbing) wavelength for H ₂ O
CH4 Seconds	Time from the LI-7700
CH4 Nanoseconds	Time from the LI-7700
CH4 (μmol/mol)	CH ₄ mole fraction
CH4 (mmol/m ³)	CH ₄ concentration density
CH4 Signal Strength (RSSI)	RSSI value measured by the LI-7700
CH4 Diagnostic Value	Diagnostic value output by the LI-7700

Configuring Eddy Covariance Measurements



The **Site Setup** window is where you configure most of the eddy covariance system settings. The information entered here will comprise the metadata file, which describes the system setup. A more complete description of the metadata file can be found in the online help information provided with EddyPro[®] Software (<http://licor.com/env/help/eddypro/index.html>). The addition of the metadata file inside the .ghg file, while adding a negligible amount of bytes (it contributes about 0.1% to the file size), allows you to:

- Avoid duplicate retrieving and re-typing of information needed for processing the file from any external data source;
- Easily store raw data for future reprocessing;
- Account for dynamic site parameters that change over the course of the data collection period (e.g., the canopy height of a crop);
- To a large extent, simultaneously process files acquired with different set-ups.

IMPORTANT: The SMARTFlux System will not compute flux results if metadata are not entered properly.

Ideally, you are not required to consider the metadata file explicitly, as it is created and modified by the gas analyzer data logging software and used unobtrusively by EddyPro[®]. Nevertheless, all information is stored as plain text and can be retrieved and edited at any time.

Eddy Covariance Checklist

Table 3-2 below is a checklist of settings that either must be set or that we recommend setting before recording datasets that can be processed by the SMARTFlux System or EddyPro® Software. Review this checklist to be sure that everything is set properly.

Table 3-2. Checklist of mandatory and recommended EC system settings. **Note:** *Some of the settings below are required in order to log valid EC datasets.*

Software Field	Recommended Setting	See Section
Settings > Time		
Clock Sync (PTP):	Automatic	<i>System Clock</i> on page 3-16
Time Zone:	Your time zone	
Site Setup > USB Log File		
Update Rate (Hz):	10 Hz (recommended; 5 Hz min)	<i>Configuring the USB Log File</i> on page 3-17
File Duration:	30 Minutes	
Compress files (.ghg)	✓ (check this box)	
When out of space:	As desired	
Site Setup > Site Description		
Station name:	Name of the station	<i>Entering the Site Description</i> on page 3-18
Canopy height (m):	Measured at site	
Use SMARTFlux Coordinates	✓ (check this box)	
Site Setup > Anemometer		
Manufacturer:	Make of anemometer	
Model:	Model of anemometer	<i>Entering Anemometer Information</i> on page 3-20
Head correction applied internally:	For the CSAT3, ✓ if true	
North alignment:	For Gill models, select the anemometer setting	
Wind data format:	Select the setting set in the anemometer	
North Offset (°):	Measured at site	
Height (m):	Measured at site	

Table 3-2. Checklist of mandatory and recommended EC system settings. Note: Some of the settings below are required in order to log valid EC datasets. (...continued)

Software Field	Recommended Setting	See Section
Anemometer > Input Settings		
Aux1	Type: U; Units: m/s	<i>Configuring the Anemometer Inputs</i> on page 3-23
Aux2	Type: V; Units: m/s	
Aux3	Type: W; Units: m/s	
Aux4	Type: Ts; Units: °C	
Site Setup > CO₂/H₂O Analyzer		
Northward separation (cm):	Measured at site	<i>Entering CO₂/H₂O Analyzer Information</i> on page 3-27
Eastward separation (cm):	Measured at site	
Vertical separation (cm):	Measured at site	
CO ₂ /H ₂ O Log Values	Select All or Default	
Site Setup > CH₄ Analyzer (if using an LI-7700)		
Connect to LI-7700	Select if using LI-7700	<i>Entering LI-7700 Information</i> on page 3-30
Northward separation (cm):	Measured at site	
Eastward separation (cm):	Measured at site	
Vertical separation (cm):	Measured at site	
CH ₄ Log Values	Select All or Default	
Site Setup > Biomet (if using a Biomet system)		
Connect to Biomet	Select if using Biomet system	<i>Entering Biomet System Information</i> on page 3-33
Sync clock to 7550	✓ (check this box)	
SMARTFlux		
Connect to SMARTFlux System	Click the SMARTFlux button and select the unit	<i>Connecting with the SmartFlux System</i> on page 3-35

System Clock

IMPORTANT: In order to synchronize instrument clocks with GPS satellites through the SMARTFlux System, PTP time keeping must be enabled.



Click **Settings**, under the **Time** tab, set **Clock sync (PTP)** to **Automatic** and the time/location will be updated when the data is received from satellites. When using PTP time keeping, the other fields (Date, Time, and Time Zone) are populated automatically. PTP will override any settings you enter.

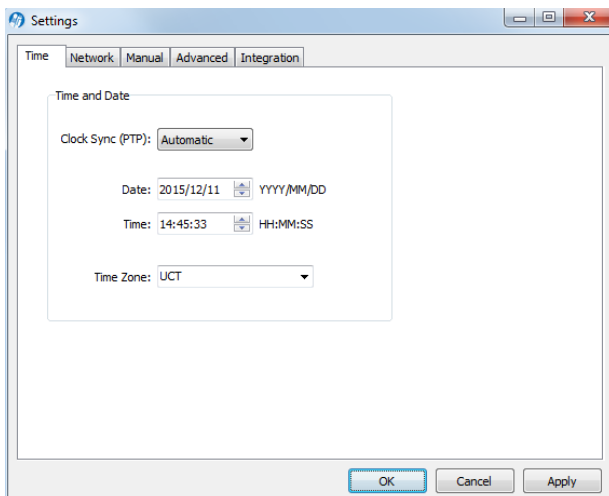

If you do not want to use GPS time, simply unplug the GPS antenna cable from the SMARTFlux System. This will also disable the GPS location, however.

Configuring the USB Log File



Data will be logged to a USB flash drive inside the LI-7550 Analyzer Interface Unit. The USB Log File tab is where you configure the Update Rate, File Duration, and the action to take should the USB flash drive run out of space. The values to be logged to the USB flash drive from the LI-7200RS, LI-7500RS, LI-7700, and Biomet System datalogger are chosen under the CO₂ Analyzer, CH₄ Analyzer, and Biomet tabs, respectively.

Set the Update Rate (≥ 10 Hz recommended).

Check "Compress files (.ghg)" so data can be processed by EddyPro or SMARTFlux System.

Select your preference for managing data when the USB drive becomes full.

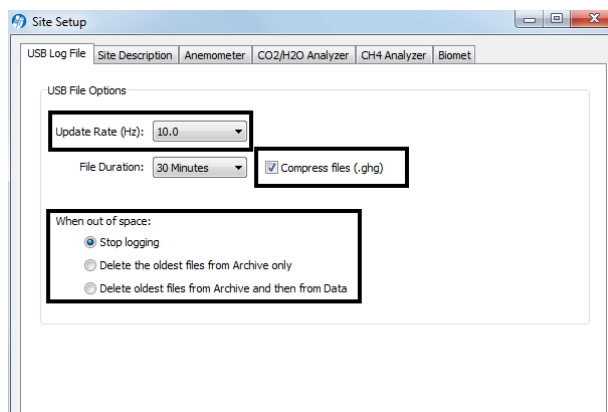

Data can be logged at up to 20 Hz. These files can be split into smaller files at 30 minute, 1 hour, 2 hour, or 4 hour intervals. For eddy covariance, select 30 minutes.

Note: Files are split based on the instrument clock. If you choose to split the files at 15 minute intervals, and start logging at 10:22, the file will be split at 10:30, 10:45, 11:00, etc.

All files are assigned a timestamp with the format YYYY-MM-DDTHHMMSS_InstrumentName.ext, where date and time are year, month, day, and HHMMSS is 24-hour time (e.g. hour 15 = 3:00 p.m.). The file extension appended is either .data, .metadata, or .status.

Entering the Site Description



The **Site Description** tab is used to enter information about the site. This information configures the metadata file that is used for flux processing.

IMPORTANT: Some entries in the gas analyzer software are required for the SMARTFlux System or EddyPro software to proceed with calculations. ***If you do not enter this information or enter it incorrectly, the SMARTFlux System will not calculate fluxes or will compute incorrect results.*** Be sure to complete the fields marked below as ***mandatory*** and review the *Eddy Covariance Checklist* on page 3-14.

Site name: Name of the research site (e.g., Marsh).

Station name: Name of the flux stations within the site.

Canopy height (*mandatory*): Site canopy height; meters.

Displacement height: Also referred to as zero plane displacement height, the displacement height of a vegetated surface (usually designated d) is the height at which the wind speed would go to zero if the logarithmic wind profile was maintained from the outer flow all the way down to the surface (that is, in the absence of vegetation). In other words, it is the distance over the ground at which a non-vegetated surface should be placed to provide a logarithmic wind field equal to the observed one. For forest canopies, the displacement height is estimated to vary

between 0.6 and 0.8 times the height of the canopy. If not entered explicitly, EddyPro computes displacement height as:

$$d = 0.67 \times \text{canopy height} \quad 3-1$$

Roughness length: In the logarithmic wind profile, the roughness length is the height at which wind speed is zero (indicated by z_0). It provides an estimate of the average roughness elements of the surface. With vegetated surfaces, because the vegetation itself provides a certain roughness, the logarithmic wind profile goes to zero at a height equal to the displacement height plus the roughness length. If not entered explicitly, EddyPro computes roughness length as:

$$z_0 = 0.15 \times \text{canopy height} \quad 3-2$$

Use SMARTFlux GPS Coordinates (*mandatory*): Uses GPS location from SmartFlux System for the station location.

Note: If you are testing the SmartFlux System in a building, the GPS signals may be too weak for the system to find the location, and the software will not show a location. The system will get this information whenever it gets adequate GPS signals.

GPS format (WGS84): Latitude and longitude coordinates are automatically detected by the SmartFlux System or they can be entered manually.

Format	Description	Example
DDD MM SS.SSS	Degrees, minutes and seconds with North, South, East, or West suffix	12°20'44" N, 98°45'55" W
DDD MM.MMM	Degrees and decimal minutes with North, South, East, or West suffix	12°20.736' N, 98°45.924' W
Decimal Degrees	Decimal degrees with negative numbers for South and West	12. 3456, - 98.7654

Latitude (*mandatory if "Use GPS Coordinates" is not selected*): Site latitude.

Longitude (*mandatory if "Use GPS Coordinates" is not selected*): Site longitude.

Altitude (*mandatory if "Use GPS Coordinates" is not selected*): Altitude (in meters) of the research site.

Entering Anemometer Information



The Anemometer tab allows you to enter information about the sonic anemometer, including the manufacturer and model, data output format, offset from true north, and height. Some of the available options (e.g., North Alignment) will change, depending on the chosen model.

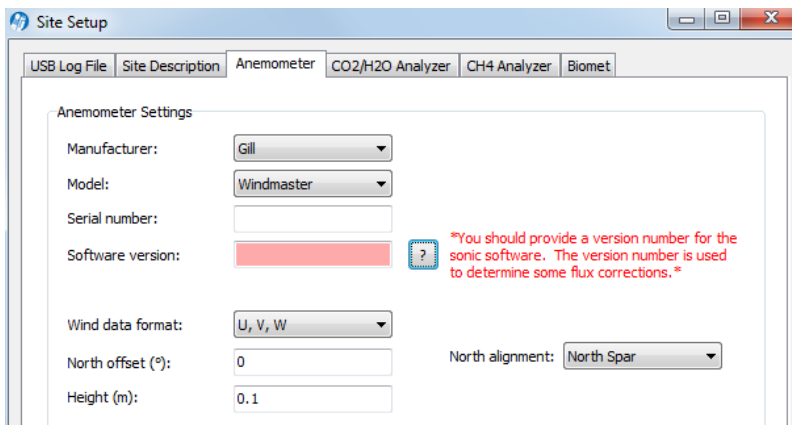

Choose the sonic anemometer manufacturer and model in the menus. LI-COR supports the following sonic anemometer models:

Manufacturer	Model(s)			
Campbell Scientific®	CSAT3			
Gill Instruments	HS-50™	HS-100™	R2	R3-50™
	R3-100™	WindMaster™	WindMaster™ Pro	
Metek	uSonic-3 Class A (or USA-1 Standard)		uSonic-3 Scientific (or USA-1 Fast)	
R.M. Young	81000			

Wind data format (mandatory): From the three axis velocities, the wind speed is calculated, and output as either signed U, V, and W, as Polar and W, or as raw velocity values. The units of output are set during the anemometer configuration.

Choose the wind data format from the menu:

- U, V, W (some Gill anemometers): U is defined as toward the direction in line with the north spar, as shown in the diagram below. V is defined as toward the direction of 90° counter-clockwise from the N/Reference spar. W is defined as vertically up the mounting shaft.
- Polar, W - The wind speed in the UV plane, with direction in degrees from 0 to 359°, with respect to the Reference spar (normally aligned to North).
- Axis velocities - Raw velocity values for U, V, W.

North offset (°): Offset, in degrees (0-359°) from which the Reference spar/axis or orientation of the anemometer varies from geographic/magnetic north.

Important note on North Offset:

EddyPro requires the offset with respect to geographic north as two pieces of information: The offset with respect to geographic north and the magnetic declination. Currently the software does not provide an entry for magnetic declination. For the best results, enter the North Offset to magnetic North. This will create small differences in the wind direction between EddyPro and the SMARTFlux results (a constant offset equal to the magnetic declination), but the flux results will be the same, if all other settings are the same.

Height (m) (*mandatory*): Sonic anemometer height above the ground, in meters, measured to center of the anemometer sample volume.

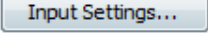
Input Settings (*mandatory*): The  button opens the Auxiliary Inputs window, where you configure the measurement type, units, label, and scaling coefficients. See *Configuring the Anemometer Inputs* on page 3-23.

About Sonic Anemometer Inputs

LI-COR offers a variety of sonic anemometers manufactured by Gill Instruments Ltd. (Hampshire, England). You can use an anemometer from another manufacturer as well, provided it has a linear voltage output and a maximum voltage output of $\pm 5V$.

When purchased from LI-COR, the Gill Instruments sonic anemometers are configured for eddy covariance measurements, however, you will be well served to review and change the anemometer settings for your site and setup.

For the purposes of the following discussion, we present some settings that are suitable for a wide range of scenarios:

Table 3-3. Gill WindMaster settings that are suitable for many EC setups.

Field	Option
Message Output Format	Mode 1 ASCII UVW continuous
Baud Rate	19200
Output Rate	>20 Hz recommended
Message Terminator	<cr><lf>
Measurement Units	m/s
Alignment	North to Spar
Averaging	(0=off) 0
Resolution	Normal resolution
Minimum Direction Resolution	50
SOS/Sonic Temp Display	SOS & Sonic Temp
Display Analogue Inputs	Off
Analog Output Mode	±5V recommended
PRT setting	Off
Unit Identifier	Q
Power on Message	Display Power on Message
Retries Enabled	On
Instantaneous Sampling	Off
Calibration Enabled	On
ASCII Format	Fixed Format
DAC Channel 1 (field)	U output
DAC Channel 1 (range)	-30 to +30 m/s
DAC Channel 2 (field)	V output
DAC Channel 2 (range)	-30 to +30 m/s
DAC Channel 3 (field)	W output
DAC Channel 3 (range)	-5 to +5 m/s
DAC Channel 4 (field)	Sonic Temp
DAC Channel 4 (range)	-40 to 70 °C
Rolling Average for Velocity Fields	Off
Rolling Average Depth	1

Configuring the Anemometer Inputs

The **Inputs** dialog must be configured in order to scale data from the anemometer properly.

IMPORTANT: It is mandatory to specify the scaling of the wind speed measurements to allow EddyPro Software and the SMARTFlux System to read these values and calculate fluxes.

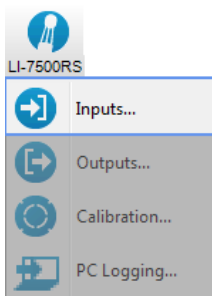

Input Settings...

- The four **Auxiliary Inputs** (Aux1...Aux4) correspond with U, V, W, and T_s (or SOS) output from the anemometer.
- **Type** specifies the variable.
- **Units** are the units that will be logged with the variable.
- **Label** is logged in the data and metadata. It identifies the variable.
- **Slope** and **offset** values relate the measured variable with the voltage.

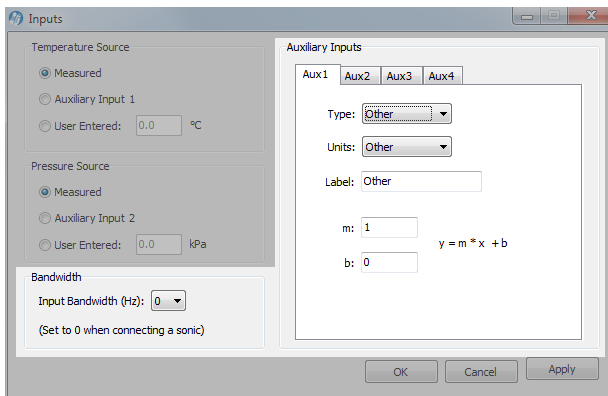

1. Choose the Type of Input.

The **Type** field allows you to choose from:

- **U** – Horizontal wind speed (m/s) as measured toward the direction in line with the north spar (see diagram below)

- **V** – Horizontal wind speed (m/s) as measured toward the direction of 90° counterclockwise from the north spar
- **W** – Vertical wind speed (m/s) as measured up the mounting shaft
- **T_s** – Sonic temperature (°C)
- **SOS** – Speed of sound (m/s)

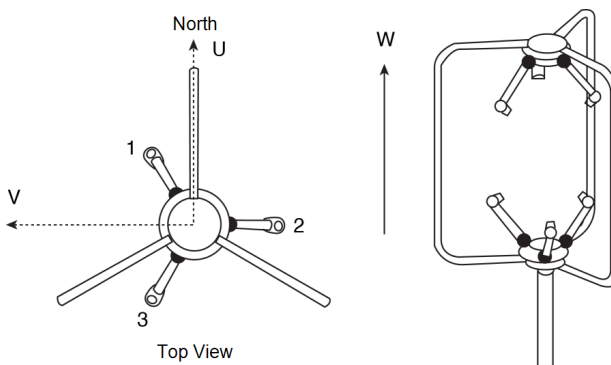

2. Choose the appropriate Units.

The units available are typical wind speed units. The software provides some controls over the units that are available with each variable:

Type	Units
Other	Other, m/s, cm/s, volts, K, and C
U	m/s, cm/s, volts
V	m/s, cm/s, volts
W	m/s, cm/s, volts
T _s	K, C, volts
SOS	m/s, cm/s, volts

3. Enter the Label.

The Label will appear in the file header in both the data and/or metadata files. The label cannot be changed for any of U, V, W, T_s, or SOS. The label can be entered only when 'Other' is selected.

Slope Offset Examples

The units selected for each auxiliary input determine the **units label** recorded in the data file header, as well as the file header in the metadata file used with EddyPro[®] Software. As such, it is important convert the anemometer output from voltage to data using the multiplier and offset.

For example, if you have configured your sonic anemometer to output U, V, and W values in volts, but want the data file and metadata file to record these values in m/s, you will need to set the multiplier and offset values to rescale the data.

The following table gives the appropriate values for m (multiplier) and b (offset) to be used when converting raw voltages into units of m/s, using the default sonic anemometer output ranges of -30 to +30 m/s for U and V, -5 to +5 m/s for W, and -40 °C to 70 °C (and speed of sound 300 to 370 m/s).

	U, V		W		T _s		SOS	
	-30 to +30 m/s		-5 to +5 m/s		-40 to 70°C		300 to 370 m/s	
Sonic output (V)	m	b	m	b	m	b	m	b
0-5V	12	-30	2	-5	22	-40	14	300
±5V	6	0	1	0	11	15	7	335
±2.5V	12	0	2	0	22	15	14	335

Example 1: You have configured the Gill WindMaster to output raw voltages for auxiliary input U over the range of 0 to 5 V, and over a full scale wind speed of -30 to +30 m/s. You want to convert the raw voltages to wind speed and output the values in units of m/s. What is the wind speed when the sonic anemometer outputs a raw voltage value of 0.5 V?

1. Set the **Type** field to U. Set the **Units** field to m/s. The **Label** is set automatically.
2. Enter 12 for the Multiplier (m) and -30 for the Offset (b).

Using the slope intercept equation:

$$y = m \cdot x + b \quad 3-3$$

the wind speed is calculated as

$$y = 12(0.5) + (-30) = -24 \text{ m/s} \quad 3-4$$

Example 2: You have configured the Gill WindMaster to output raw voltages for auxiliary input U over the range of $\pm 5V$, and over a full scale wind speed of -30 to +30 m/s. You want to convert the raw voltages to wind speed and output the values in units of m/s. What is the wind speed when the sonic anemometer outputs a raw voltage value of 1.5V?

1. Set the **Type** field to U. Set the **Units** field to m/s. The Label is set automatically.
2. Enter 6 for the Multiplier (m) and 0 for the Offset (b).

Using equation 3-3 on the previous page, the wind speed is calculated as

$$y = 6(1.5) + 0 = 9 \text{ m/s}$$

3-5

Entering CO₂/H₂O Analyzer Information



The CO₂/H₂O Analyzer tab shows the type of CO₂/H₂O analyzer used (LI-7500RS or LI-7200RS), the values to log to the USB drive, and the gas analyzer position relative to the sonic anemometer.

The distance between the gas analyzer and sonic anemometer is used to estimate the high-frequency flux losses. Distances are provided in a Cartesian coordinate system, which allows EddyPro[®] to determine the distance from a gas analyzer and the anemometer.

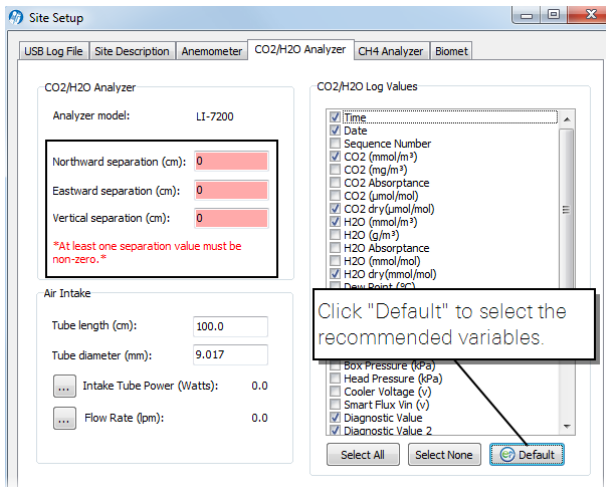

Important: At least one separation must be different from 0. Values are relative to the sonic anemometer and measured at the site. Entering wrong values will result in incorrect flux calculations.

- Measurements must be provided in the indicated units.
- The anemometer is the center (0, 0) of the coordinate system.
- For all gas analyzers, the distances from the reference anemometer are provided along the north-south east-west axes.

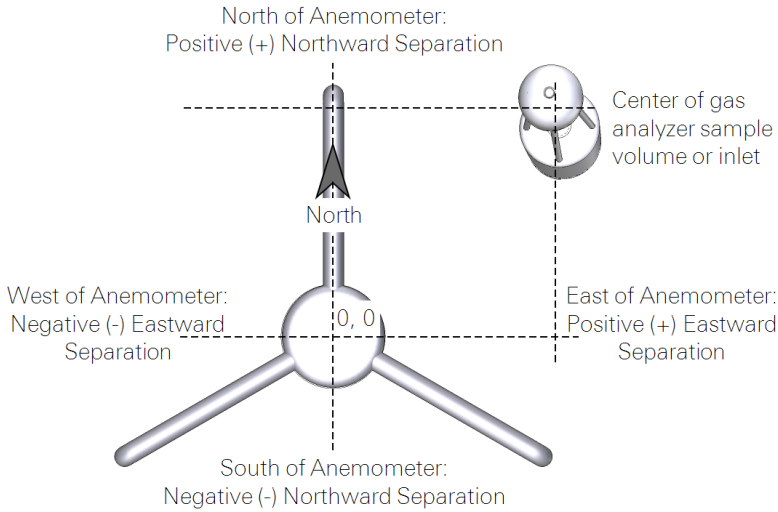

Figure 3-2. Eastward and northward separation of the gas analyzer relative to the sonic anemometer.

Northward Separation (cm) (mandatory): North or south distance between the LI-7500RS sample path and the anemometer. Positive values if north and negative values if south of the anemometer.

Eastward Separation (cm) (mandatory): East or west distance between the LI-7500RS sample path and the reference anemometer. Positive values if east and negative values if west of the anemometer.

Vertical Separation (cm) (mandatory): Vertical distance between the sample path and the reference anemometer. This value is negative if the center of the analyzer intake tube inlet is below the center of the reference anemometer sample volume and positive if the inlet is above.

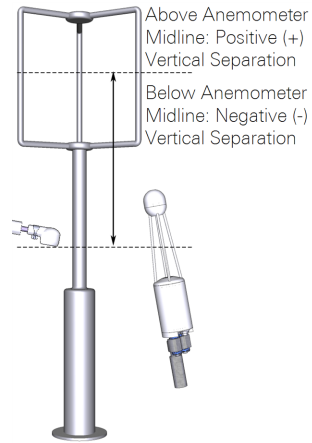

Figure 3-3. Vertical separation of the gas analyzer sample path or inlet relative to the sonic anemometer.

CO₂/H₂O Log Values (*mandatory*): Click **Default** to select data records recommended for use with SMARTFlux System and EddyPro Software.

Entering LI-7700 Information

The LI-7550 Analyzer Interface Unit can be connected to any LI-7700 Open Path CH₄ Analyzer that is on the network or connected directly to the LI-7550. This enables you to log LI-7700 data in the same dataset collected by the LI-7500RS.

Connect with an LI-7700

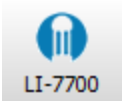

Click on the  button in the **Site Setup > LI-7700** dialog box or the LI-7700 button in the dashboard to connect to an LI-7700 CH₄ analyzer.

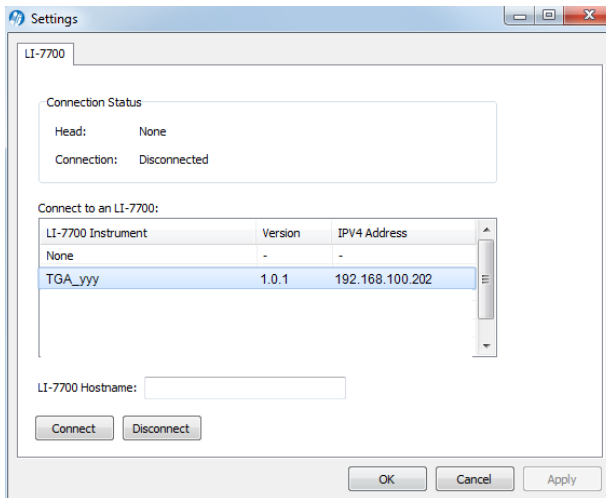

The LI-7700 tab displays a list of LI-7700 instruments available on the network (same subnet as computer). Select an LI-7700 from the list or enter an IP address in the 'LI-7700 Hostname' field (networked device on different subnet mask as computer) and click **Connect**. Click **Apply** or **OK**. When you start logging data with the LI-7550 via USB, the chosen data values for the LI-7700 will be logged, as well.

Important: To synchronize the clocks of the LI-7500RS or LI-7200RS and the LI-7700, be sure to configure the PTP time setting in the LI-7700 to **Slave** or **Automatic**.

Enter Analyzer Information



Here you specify the separation between the sonic anemometer and the LI-7700 sample volume.

Important: At least one separation must be different from 0. Values are relative to the sonic anemometer and measured at the site. Entering wrong values will result in incorrect flux calculations.

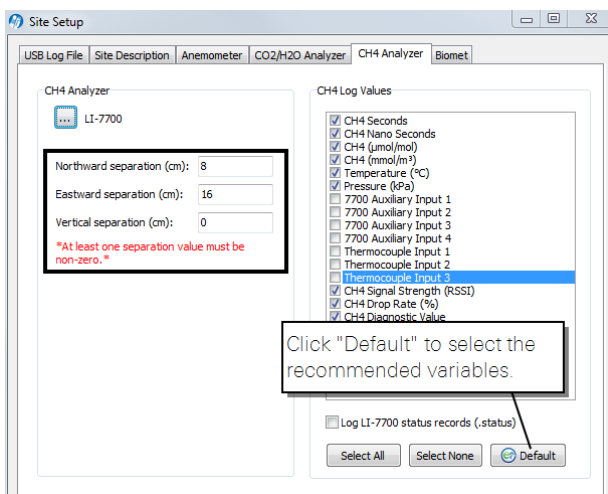

Northward Separation (cm) (mandatory): North/south distance between the LI-7700 Analyzer and the reference anemometer. Positive values if north and negative values if south of the anemometer (see *Figure 3-2* on page 3-28).

Eastward Separation (cm) (mandatory): East/west distance between the LI-7700 Analyzer and the reference anemometer. Positive values if east and negative values if west of the anemometer (see *Figure 3-2* on page 3-28).

Vertical Separation (cm) (mandatory): Vertical distance between the LI-7700 Analyzer and the reference anemometer. This value is negative if the center of the LI-7700 sample volume is below the center of the reference anemometer sample volume and positive if the gas sample is above (see *Figure 3-3* on page 3-28).

Select Variables

In the Site Setup dialog, click  to select the recommended variables for processing in EddyPro and the SMARTFlux System or click Select All to log all variables.

The LI-7700 data values to be logged to the USB drive are chosen under CH4 Log Values. In addition, you can enable the ‘Log LI-7700 status records (.status)’ check box to collect LI-7700 STATUS records. The log values available for the LI-7700 Open Path CH₄ Analyzer include:

Table 3-4. LI-7700 variables available for logging in compressed .ghg files.

Variable	Description
CH4 (μmol/mol)	Methane mole fraction ¹
CH4 (mmol/m ³)	Methane number density
Temperature (°C)	Temperature measured by LI-7700 thermocouple
Pressure (kPa)	Pressure measured by LI-7700
7700 Auxiliary Input 1	Auxiliary input 1
7700 Auxiliary Input 2	Auxiliary input 2
7700 Auxiliary Input 3	Auxiliary input 3
7700 Auxiliary Input 4	Auxiliary input 4
Thermocouple Input 1	Auxiliary thermocouple input 1 (°C)
Thermocouple Input 2	Auxiliary thermocouple input 2 (°C)
Thermocouple Input 3	Auxiliary thermocouple input 3 (°C)
Signal Strength (RSSI)	Signal strength (Residual Signal Strength Indicator (0-100%))
Drop Rate (%)	Percentage of 1000 Hz scans dropped (0-100%)
Diagnostic Value	Diagnostic value, an integer

¹For calibrations and mean values; should not be used for eddy covariance calculations.

Entering Biomet System Information

The LI-7550 Analyzer Interface Unit can be connected to any properly-configured LI-COR Biomet system on the network to integrate biomet data into the dataset collected by the LI-7500RS. These data are summarized in EddyPro software or the SMARTFlux System and can be used in the flux calculations.

Connecting to a Biomet System



Click on the  button next to Sutron 9210B or click the Biomet button from the dashboard to open the **Settings** window, where you can connect to a Sutron data logger.

The Biomet window displays a list of Sutron 9210B Dataloggers available on the network (same subnet mask as computer). Select a Sutron 9210B from the list, or enter an IP address in the '9210 Hostname' field (networked device on different subnet mask as computer) and click **Connect**. Click **Apply** or **OK**. When you start logging data with the LI-7550, the chosen data values for the 9210B will be logged and summarized in the SMARTFlux System output.

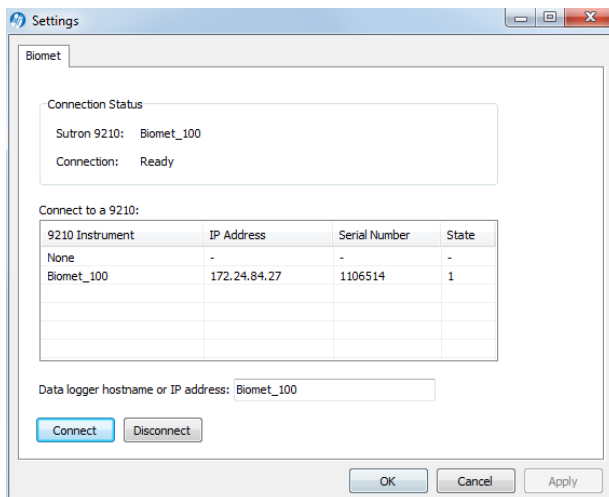

View Sensors



After connection, the software will display a list of biomet sensors configured for use with the selected Sutron datalogger (under **Sensors**). Click on any sensor in the list to display the Sensor Properties (Type, Units, and Value) for the selected sensor. Note that the **Sensors** and **Sensor Properties** are configured through the 9210B; this list is for reference only.

NOTE: Enable the ‘Sync clock to 7550’ to synchronize the Sutron 9210B and LI-7550 clocks.

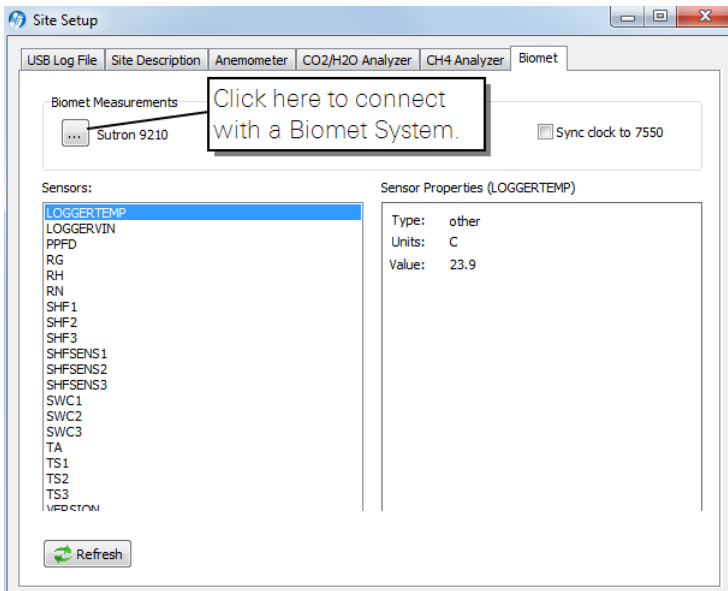

Refer to the Biomet Station Instruction Manual for more information.

Connecting with the SMARTFlux System



The SMARTFlux System window displays a list of all SMARTFlux Systems that are connected to your network of sensors. In this window, you select a SMARTFlux System and connect to it by clicking the **Connect** button.

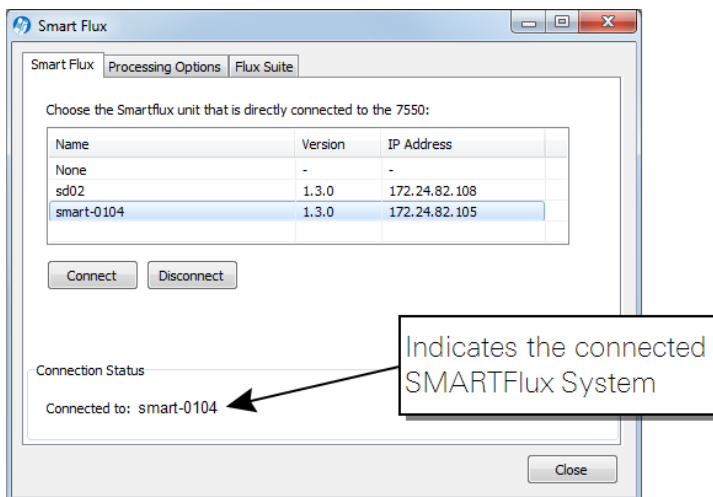

Processing Options

Two processing settings are available in the **Processing Options** tab: **Express Mode** and **Advanced Mode**.

- Express settings are used by default. To use Express mode, simply connect with the SMARTFlux System or click **Use Express Mode** to activate the setting. See *Express Processing* on page 3-41.
- To process data with EddyPro Advanced settings, click the **Upload Advanced File** button and select the `.smartflux` file created in EddyPro. The file will load and EddyPro will compute flux results based upon the settings defined within. Refer to the EddyPro documentation for more information. See *Overview of Advanced Processing* on page 3-42.

Begin Logging Data



Under the **Site Setup** menu, each tab has **Start**, **Stop**, and **Eject** buttons.



You can open the logging controls by clicking the  log button.



Click **Start** to begin logging data. Press **Stop** to quit logging, and **Eject** to unmount the USB drive. Always eject the USB drive properly before removing it. After pressing the **Eject** button, the LED inside the LI-7550 will turn off when it is safe to remove the drive.

Important: When you stop datalogging, the time-series file that is being collected will be saved to USB drive in component form (including the high-speed data, site metadata, and other files, if applicable), however, *it will not be compressed* into a .ghg file, and subsequently, *it will not be processed* by the SmartFlux System.

However, you can change the metadata settings or toggle Advanced and Express processing while data is being logged—without stopping datalogging. The updated metadata will be recorded in the next .ghg file that the system creates. Under this scenario, all files will still be compressed and processed by the SmartFlux System. *To log an uninterrupted series of .ghg files, do not stop logging data when you change the metadata or other settings.*

Overwriting Files on the USB Flash Drive

If the USB drive becomes full of logged data, you can configure the behavior of the system by choosing the following settings.

- Stop logging
- Delete files from the archive (if files are present there) and continue logging
- Delete files from the archive first, followed by the oldest data files

The file transfer program (see *Transferring Logged Data* on page 3-39) that can be used to transfer files from the USB drive to your computer remotely, provided you are connected to the LI-7550 Analyzer Interface Unit via an Ethernet connection. This, coupled with the optional file compression described above can obviate the need to retrieve the USB flash drive to download data. We recommend, however, that you periodically check the USB drive to make sure it is functioning correctly, and to not depend upon the USB drive as a permanent archive for logged data.

About File Compression (USB Logging Only)

CO₂/H₂O measurements, wind speed measurements, CH₄ measurements (with the LI-7700), Biomet measurements (with the Biomet System) and site metadata are logged in a compressed archive if you click the ‘Compress files (.ghg)’ check box. Files are typically compressed at a ratio of about 4:1 (can be as high as 10:1, depending on file attributes). As an example, if the LI-7500RS and LI-7700 CH₄ Analyzer are both logging data at 20 HZ, with 53 columns of data, a one hour file would be approximately 30 MB uncompressed, and 7 MB compressed, for an approximate 4x compression ratio.

File compression is essential to log .ghg files that are processed in EddyPro software or the SmartFlux System. The .ghg file contains an archive consisting of the data file (.data extension), a metadata file (.metadata extension), and an optional LI-7700 status file (.status extension).

When file compression is enabled, an archive is created and the file name is appended with a .ghg file extension. To view the contents of a .ghg file, you can change the file extension to .zip and unzip it with the extraction tool included with Windows® or unzip the .ghg file using a program such as 7-zip.

Files are saved and compressed after the **File Duration** interval has elapsed. If the file duration is set to 15 minutes, the first .data file will be collected for 15 minutes (or some part thereof), after which it will be compressed, and the second data file will commence for 15 minutes, after which it is compressed, and so on.

Note: If the file duration is set to **Continuous**, files will not be compressed.

If you log all variables at 10 Hz (10 samples per second), approximately 180 MB of data will be generated each day. Thus, the 16 GB drive can collect about 80 days of data with no compression. With compression, a daily file would be about 50 MB; the 16 GB drive can collect about 288 days of data.

File Types

The data file is an ASCII text table with a header, and tab-delimited rows of data. When paired with the metadata file, the data file header is ignored by EddyPro® Software, which uses the metadata file to interpret the data columns and to retrieve the appropriate meta-information needed to calculate fluxes. The metadata information is stored as plain text, and can be retrieved and edited as desired. Typical metadata includes information such as site and setup, the instruments, and the variable definitions, including physical units.



Transferring Logged Data

If the LI-7550 is connected to a network via Ethernet or a cellular modem, you can transfer files and manage data on the USB drive from a networked computer.

The file transfer program is installed automatically with the gas analyzer software. Launch it by clicking the **Download** button.

To connect to an instrument, click **Browse** to view a list of instruments on the network. Select the instrument, click **OK**, enter the password (**licor**) and click **Verify Connection**. If your instrument is not listed, type the IP address in to the **IP Address** field.

Check the **Save login information** box if you want the file transfer program to remember this IP address and password the next time you start the program.

USB Drive Information displays the size of the USB drive, available memory, number of .ghg files, number of flux results files, number of daily summary files, the number of files in the archive. When new files are transferred, they are then moved to the archive or deleted, depending on the Transfer Options selected.

Transfer Options are used to configure settings and other features:

- **Destination:** This is where the transferred files will be placed. Ideally, this will be a directory on your computer or a server. Or you can choose a cloud-based service such as a Dropbox directory on you computer.
- **When to transfer:** You can **Transfer files daily** at a scheduled time or **Transfer files now** (click the start button).

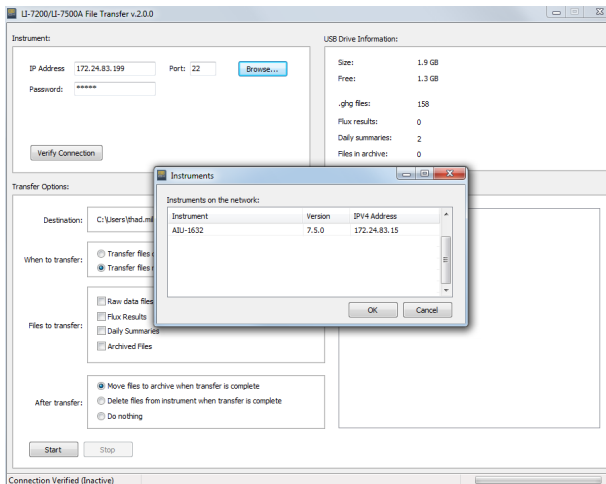

Note: You can close the application to your system tray (close it, but choose **No**) so it continues running in the background. Also be sure your computer does not go to sleep before the scheduled transfer.

- **Files to transfer:** Select **Raw data files** (.ghg, .data., metadata) to transfer all raw data files. Select **Flux Results** to transfer SMARTFlux System results. Select **Daily Summaries** to download a small summary of the flux results. Select **Archived files** to copy the archives.

Note: When you check a box a corresponding tab will be added to the box. Here you can choose which files you want to download.

- **After transfer:** You can choose **Move files to the archive**. This is useful if you want to keep a copy of the files on the USB drive but you want them compressed to save space. You can **Delete files** from the instrument will remove them from the USB drive. Use this option if you want to clear space from the flash drive and you have backed up the data elsewhere. You can also choose to **Do nothing** after the transfer.

After configuring the transfer and selecting files, click **Start**.

Tips for Automatic Data Transfer:

- Set the download to begin at 00:15 (1:15 am) if you are using SMARTFlux. That way all the logged files will be processed before the download begins.
- Close the application to your system tray to keep it running in the background.
- Be sure the computer that runs the application is on and not in power saver mode.
- Download files daily, if possible, to avoid long wait times for data transfer.

You can also use third-party applications to transfer data, such as WinSCP. In this case, use:

- Port: **22**
- Username: **licor**
- Password: **licor**

Running SMARTFlux

When using SMARTFlux System with express settings, there really is nothing additional for you to do beyond entering site information and configuring your sensors. But, when your site conditions or objectives require advanced settings, you will use EddyPro to create the SMARTFlux advanced configuration file. This section provides a detailed summary of the steps involved with configuring the SMARTFlux with Advanced settings.

Express Processing

EddyPro Express mode is the default configuration for the flux computation in the SMARTFlux System. Express settings are loaded automatically unless you specify an EddyPro Advanced configuration file. In most cases, EddyPro Express provides final, fully corrected and valid fluxes that can be directly used for further analysis. In a few special cases, however, Express fluxes may not be fully accurate and only serve a diagnostic purpose.

Automatic Variable Selection

In standard EddyPro, even when running in Express mode, you still can select the variables to be used in flux computation, in the **Basic Settings > Select Items for flux computation** section. More precisely, EddyPro provides default choices based on the variables described in the metadata file (either embedded in .ghg files, or created in **Project Creation > Metadata file editor**), and you can keep these choices or pick other variables. For example, CO₂ fluxes from the LI-7200RS can be calculated from CO₂ measurements available as either mixing ratio, mole fraction or number density. If all of these measurements are available in the metadata file, then EddyPro defaults to the mixing ratio, and you are allowed to either keep this choice or pick one of the other two.

EddyPro defaults, and the order in which other viable variables are listed in the drop-down menus, reflect best practices suggested by LI-COR and depend on the deployed instrument(s). The exact same logic is used in SMARTFlux to select the variables to be used when multiple choices are available. In particular:

- **CO₂/H₂O measured by an LI-7200RS:** The order of preference is (1) mixing ratio, (2) mole fraction and (3) number density

- **CO₂/H₂O measured by an LI-7500RS:** Only number density can be used for flux computation
- **CH₄ measured by an LI-7700:** Only number density can be used for flux computation
- **Air temperature and pressure:** Precedence is given to measurements from an LI-7700 if available.
- **Diagnostics flags:** If available for the deployed instruments, diagnostic flags are used to filter out individual raw data based on diagnostic information.

Overview of Advanced Processing

Advanced Mode provides you with the high-level capabilities of the EddyPro Advanced, computing fully corrected flux results in real-time with the processing options of your choice.

The SMARTFlux configuration file, needed to run EddyPro in Advanced mode inside the SMARTFlux System, is created in EddyPro 5 or higher. This, and subsequent versions of EddyPro provide the capability to export a SMARTFlux configuration file, that can then be uploaded via the gas analyzer PC software. Complete documentation is provided in the EddyPro help.

There are additional considerations if you use **EddyPro Advanced** in SMARTFlux. For many scenarios, you will simply need to configure the advanced settings as you see best, and load the SMARTFlux configuration file into SMARTFlux following the instruction provided hereafter.

However, if you wish to use a **Planar-fit method for Axis Rotation**, the **Automatic Time Lag Optimization** option, or one of the **in-situ spectral correction** methods (Horst, 1997; Ibrom et al., 2007), *you will need to process an existing data set from the site in order to configure the parameters for these settings*, as explained in *Using Planar Fit, In-situ Spectral Corrections and Timelag Optimization in SmartFlux* on page 3-49.

Important: In order for the parameters to be valid, the site must not have undergone any significant changes between the time when the existing data set was collected and when the SMARTFlux System is deployed. The instrument configuration should remain unchanged during the sampling period if the settings are to apply to the SMARTFlux System configuration file as well. For closed-path systems, the dataset used to optimize time lags and for the spectral assessment must refer to a period in which the sampling line did not undergo major modifications, such as replacement of tube or filters, change of the flow rate, etc.

When you create the configuration file, only the controls that can be configured for the SMARTFlux System are enabled, and the other controls are disabled. Similarly to EddyPro Advanced and Express, some controls must be configured, while others are optional.

SMARTFlux System Configuration Steps

SMARTFlux Configuration mode is used to create an advanced configuration file for the SMARTFlux System.

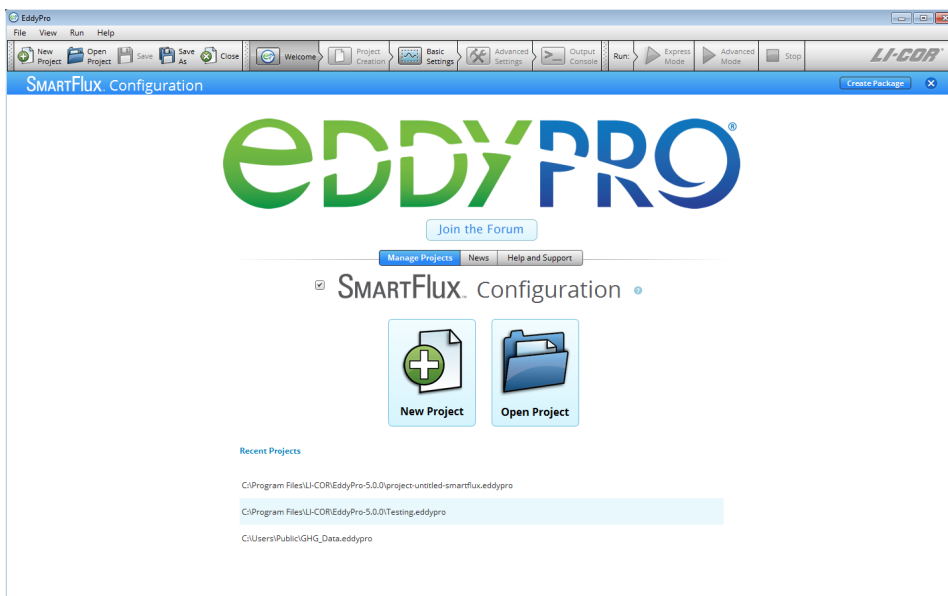

To use this mode, check the box, and proceed through EddyPro as you normally would. The steps are summarized below:

1. Click the **SMARTFlux Configuration** box.
2. Select **New Project** or **Open Project**.

SMARTFlux™ Configuration 

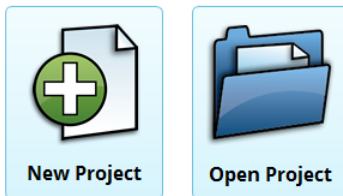

If you are creating a **New Project** and you do not intend to use planar-fit, automatic time-lag optimizations, or in situ spectral corrections:

- Set the Raw Data Directory to a .ghg file with metadata that applies to your site (see *Creating an Advanced SmartFlux Configuration File with .ghg Files* on page 3-48).
- Select variables and set flags as desired.
- Configure Advanced Settings (see *Overview of Advanced Processing* on page 3-42).

If you are creating the SMARTFlux configuration file from an existing project:

- Click **Open Project** and select the project.
- Alter any settings that need to be changed.
- Configure Advanced Settings (see *Overview of Advanced Processing* on page 3-42).

If you are using **planar-fit**, **automatic time-lag optimization**, or **in situ spectral corrections** (see *Using Planar Fit, In-situ Spectral Corrections and Timelag Optimization in SmartFlux* on page 3-49 for details):

- Select a planar-fit file that was generated by EddyPro using data from your site.
- Select the automatic time-lag optimization file that was generated by EddyPro using data from your site.
- Select the in-situ spectral corrections file that was generated by EddyPro using data from your site.

3. Click **Create Package** in the upper right of EddyPro.

Create Package

4. When prompted, name the package, select a directory and click **Create**.

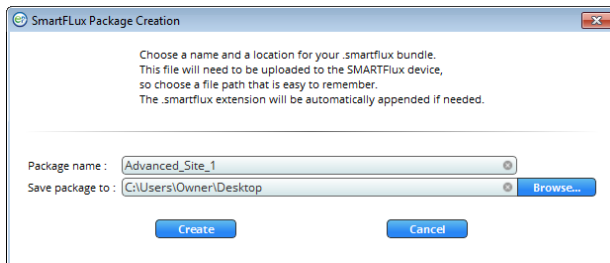

The configuration file has a `.smartflux` extension.

5. Upload the SMARTFlux configuration file to the SMARTFlux System.
See *Loading a SmartFlux Configuration File* on page 3-51.

Advanced Processing Options

Similarly to EddyPro Advanced and Express, some controls must be configured, while others are optional. When you create the SMARTFlux System configuration file, only the controls that can be configured for SMARTFlux are enabled, and the other controls are disabled. In particular, you will find that:

1. The **Project Creation** page is not available.
This is because inside SMARTFlux, EddyPro does not need any of the information that is entered in the Project Creation page. The file type (LI-COR `.ghg`), the use of metadata (“embedded”) and the use of biomet data (“embedded”) are all predefined settings in SMARTFlux.
2. In **Basic Settings**:
 - A. The selection of **Dataset dates** is deactivated because SMARTFlux processes `.ghg` files one by one, as they are created by the gas analyzer software.
 - B. The **Previous results directory** is deactivated because this option is not applicable to SMARTFlux.
 - C. The **Flux averaging interval** is deactivated because SMARTFlux operates on a predefined interval of 30 minutes. In SMARTFlux there is no option to calculate fluxes on any other time interval.
 - D. The **Master Anemometer** is deactivated because LI-COR eddy covariance systems are designed around one only anemometer, which is detected automatically in SMARTFlux as the “master”.

3. In **Advanced Settings > Processing Options**, all processing options are active, and you can select them as you would do in EddyPro.
4. In **Advanced Settings > Processing Options**, all processing options are active, and you can select them as you would do in EddyPro.

The only exception are:

- A. The **Planar Fit Settings...** dialogue, which activates when the **Planar fit** or the **Planar fit with no velocity bias** option is chosen as the **Axis rotation for tilt correction** method, presents only the **Planar fit file available** option. If you want to use the planar fit method in SMARTFlux, you will have to load a previously created planar fit file at this time. Refer to *Using Planar Fit, In-situ Spectral Corrections and Timelag Optimization in SmartFlux* on page 3-49 for instruction how to create the planar fit file and more details on how to use it in SMARTFlux.

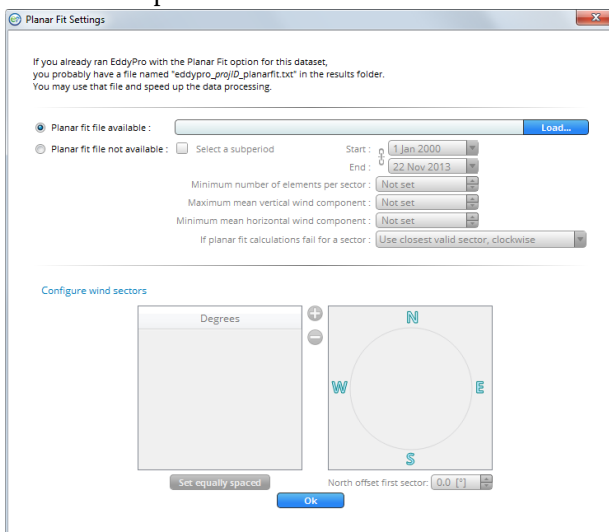

- B. The **Time lag Optimization Settings...**, which activates when the **Automatic time lag optimization** option is chosen as a **Time lag compensation** method, only gives the **Time lag file available** option. If you want to use the automatic timelag optimization option in SMARTFlux, you will have to load a previously created timelag optimization file at this time. Refer to *Using Planar Fit, In-situ Spectral Corrections and Timelag Optimization in SmartFlux* on page 3-49 for instructions how to create the timelag optimization file and more details on

how to use it in SMARTFlux.

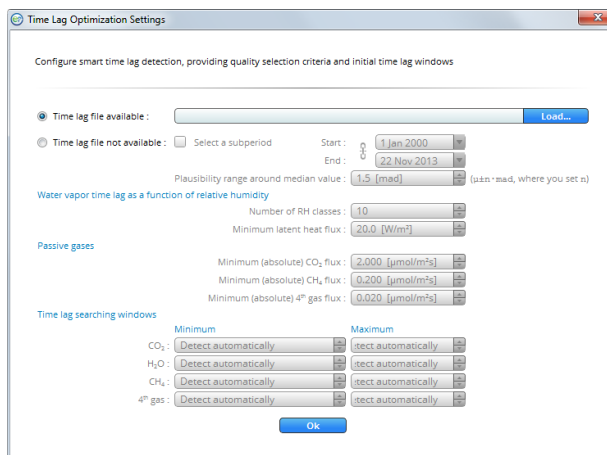

5. In **Advanced Settings > Spectral Corrections** both low frequency and high frequency corrections are available.

However:

- A. In the **Correction for low-pass filtering effects**, the method by Fratini et al. (2012) is deactivated, because this method requires an auxiliary file that is currently not available in SMARTFlux.
 - B. If an in-situ method is selected (Horst 1997 or Ibrom et al., 2007), only the option **Spectral assessment file available** is active, similar to the planar fit and timelag optimization options discussed above. If you want to use one of these in-situ methods in SMARTFlux, you will have to load a previously created spectral assessment file at this time. Refer to *Using Planar Fit, In-situ Spectral Corrections and Timelag Optimization in SmartFlux* on page 3-49 for instruction how to create the spectral assessment file and more details on how to use it in SMARTFlux.
6. In **Advanced Settings > Statistical Analysis**, all processing options are active, and you can select them as you would do in EddyPro with no exceptions.
7. In **Advanced Settings > Output Files**, most options are active, with the following exceptions:
- A. The **Set Minimal**, **Set Typical** and **Set Thorough** pre-selection buttons are deactivated, because those pre-selections do not apply completely to SMARTFlux.
 - B. The **Full output file** and related settings are deactivated because this file will always be created by SMARTFlux in a predefined format.

- C. The **Ensemble averaged cospectra and models** is unchecked and deactivated, because this output cannot be created in SMARTFlux, were .ghg files are processed one at a time. To create those outputs, use standard EddyPro instead.
- D. All full length (co)spectra outputs are deactivated. These files occupy large amounts of disk space and are thus not allowed in SMARTFlux. To obtain full length (co)spectra files, use standard EddyPro instead.
- E. Processed raw data outputs are deactivated. These files occupy large amounts of disk space and are thus not allowed in SMARTFlux. To obtain those outputs, use standard EddyPro instead.

Creating an Advanced SMARTFlux Configuration File *without* .ghg Files

If you don't have any .ghg files from the EC system for which you are going to use the SMARTFlux System, you can customize the Advanced processing options, but you will have to rely on EddyPro's selection of variables to be used for flux computation, because at this stage you will have no means to indicate which variables you are going to collect and which ones you want to use for fluxes. See *Automatic Variable Selection* on page 3-41 for more details on EddyPro default selections.

Once you have chosen the processing options of your preference, simply click on the **Create File** button on the right side of the blue SMARTFlux ribbon. This will create a bundle with extension .smartflux and save it in the selected output directory.

Creating an Advanced SMARTFlux Configuration File *with* .ghg Files

If you have at least one .ghg file from the EC system for which you are going to use SMARTFlux, you can customize the Advanced processing options, and select the variables you prefer for computing fluxes on-the-fly. In this case, in **Basic Settings** simply select the **Raw data directory** where your raw data are stored, and EddyPro will automatically populate the section **Select Items for flux computation**, as it usually does when used in the standard mode.

At this point, select the variables, configure the flags, and set the processing options of your preference and simply click the **Create File** button visible on the right side of the blue SMARTFlux ribbon. This will create a bundle with extension .smartflux and save it in the selected output directory.

Using Planar Fit, In-situ Spectral Corrections and Timelag Optimization in SMARTFlux

In order to use planar-fit, in-situ spectral corrections or timelag optimization in the SMARTFlux System, EddyPro needs to access the respective “planar_fit”, “spectral_assessment” and “timelag_optimization” files, referred to as “additional configuration files” hereafter. These files contain summaries of calculations performed on relatively large datasets (*Table 3-5* below) and that apply also to data to be collected in the future.

For example, you can use three-months of data to calculate a spectral assessment, and then use this spectral assessment that is summarized in a short text file, to correct fluxes calculated from data collected after those three months, if the system configuration didn’t change to such an extent, that the spectral assessment is no longer representative. Similar considerations apply to the planar fit and the timelag optimization procedures. Refer to EddyPro documentation for more details on when and how to use these three advanced procedures.

The additional configuration files are created by EddyPro (3.0 and above), when used in the standard desktop mode. If you have been running your EC system – for which you intend to user SMARTFlux—for some time, you may already have created one or more of these files, or you may have a .ghg dataset suitable for creating them, if the corresponding implementation is deemed necessary to calculate accurate fluxes (again, refer to EddyPro documentation to learn more about when it is suggested to use these options). If you do not have previously collected .ghg files, then you will need to run the system for a suitable amount of time (for example using SMARTFlux in Express mode), then use EddyPro in desktop mode to create the additional configuration files of your interest, and then provide them to SMARTFlux as explained below.

Table 3-5. Recommended dataset durations for Advanced settings.

EddyPro Advanced Setting	Recommended Dataset
Planar Fit Settings	2 weeks minimum; < 2 months
Time Lag Optimization	1 to 2 months or more
Spectral Corrections, Assessment of high frequency attenuation	1 month or more

Thus, assuming that you have a sufficiently long .ghg dataset (*Table 3-5* on the previous page), the procedure to correctly configure SMARTFlux to use planar-fit, in-situ spectral corrections or timelag optimization is illustrated here, using the in-situ spectral corrections as an example. Analogous procedures shall be followed for the planar-fit or the timelag optimization.

1. Open EddyPro (5.0 or above recommended) in normal desktop mode and complete the **Project Creation** and **Basic Settings** pages as usual (refer to EddyPro documentation if needed).
In the **Advanced Settings > Spectral Corrections**, configure **Corrections for low-pass filtering effects** to use one of the in-situ methods, i.e. Horst (1997), Ibrom et al. (2007) or Fratini et al. (2012). In the same page, customize the settings to instruct EddyPro to use the dataset of your choice and to filter data appropriately, so as to obtain a sound assessment of spectral attenuations. Click **Run** and when this is completed, locate the spectral assessment file (it contains the string “spectral_assessment” in the file name) in the subdirectory \spectral_analysis that you will find inside the selected Output folder. This is the file that you will use for SMARTFlux.
2. Open EddyPro (5.0 or above) in SMARTFlux Setup Mode.
Configure everything as explained in the previous sections. In the **Advanced Settings > Spectral Corrections**, configure **Corrections for low-pass filtering effects** to use one of the in-situ methods among Horst (1997) and Ibrom et al. (2007) (the method of Fratini et al. (2012) is currently not usable in SMARTFlux). In the “**Spectral assessment file available**” entry, select the spectral assessment file created earlier. Then proceed normally and when done, click on the **Create File** button to create the .smartflux bundle, as explained above.

An analogous procedure can be used to create and use the planar fit and the timelag optimization configuration files.

Loading a SMARTFlux Configuration File

Note: EddyPro Express settings are loaded by default so you only need to load a configuration file if you use EddyPro Advanced settings.

To connect with a SMARTFlux System, see *Connecting with the SmartFlux System* on page 3-35. To load an EddyPro Advanced configuration file:



1. Create the SMARTFlux configuration file (see *Overview of Advanced Processing* on page 3-42)
2. Open the SMARTFlux System dialog.
3. Select the **Processing Options** tab, and click the **Upload Advanced File** button. Read the warning dialog.

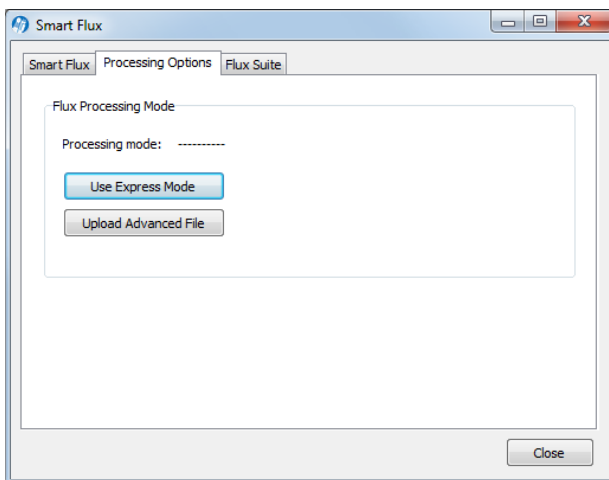

4. Browse to the file created in EddyPro (extension *.smartflux) and select it.

After loading the file, the SMARTFlux System will compute flux results based upon the defined Advanced settings. Be sure to turn on datalogging first as described in *Begin Logging Data* on page 3-36.

SMARTFlux Results Files

The SMARTFlux System writes EddyPro results files to the USB flash drive in the LI-7550. In addition to the raw .ghg files (including any .data and .metadata files), you can retrieve flux results files, daily summary files, and archived files.

Flux Results

These are the output files from EddyPro. They follow a format typical of EddyPro outputs, as described in detail in the EddyPro help (<http://www.licor.com/env/help/eddypro/index.html>).

Daily Summaries

These logged data summaries, typically named something like YYYY-MM-DD_AIU-xxxx_Summary, include the high-speed data logged in the LI-7550 analyzer interface unit. These are the variables selected in *Entering CO₂/H₂O Analyzer Information* on page 3-27.

The EddyPro summaries, typically named somethings like YYYY-MM-DD_EP-Summary, include the half-hour eddy covariance flux results. This file is created at the end of each day by collecting the results of each 30-minute file and placing them in a row. The variables included in this file are specified in EddyPro automatically if you select Basic processing or manually if you select Advanced processing (see *Advanced Processing Options* on page 3-45).

Data Backup

An emergency data backup archive is stored on the MicroSD card, which may be useful if data are lost for any reason. The backup files are limited to the latest files recorded—the oldest files are overwritten when the MicroSD card gets full. Do not depend upon the MicroSD card as a primary backup for your data, however, because old files are automatically overwritten by new ones.

Section 4. Calibration

The LI-7500RS's measurement accuracy depends upon its calibration. There are two major components to the calibration: 1) determining the values of calibration coefficients, and 2) setting zero and span. During a factory calibration, both of these steps are performed. The values of the coefficients that are determined should be valid for several years. The zero and span adjustments are used to bring the LI-7500RS's actual response into line with its previously determined factory response, at least at two points.

Important: Check the zero and span at regular intervals; monthly at first, and then adjust the frequency according to the stability of the instrument; see *How Stable are Zero and Span?* below.

How Stable are Zero and Span?

The analyzer's zero is primarily affected by temperature, and the state of the internal chemicals. The internal chemicals should be changed annually (see *Replacing the Internal Chemicals* on page 5-4). The zero's response to temperature is relatively small (typically 0.1 or 0.2 ppm per °C for CO₂, or 0.01 mmol/mol/°C for H₂O). Also, this drift is measured at the factory, and subsequently compensated for in software (equation 8-10), so the effective zero drift should be quite small. Therefore, the zero should be quite stable over a several month period, but you might want to check it after an extreme temperature change (>30 °C).

The analyzer's span is affected by temperature, pressure, and the state of the internal chemicals.

- **Temperature:** A 10 °C change will typically change the H₂O span by 1 to 2%. For CO₂ at ambient concentrations, the span is very insensitive to temperature.

- **Pressure:** A large pressure change (40 kPa) will affect the CO₂ and H₂O spans by <1%, for ambient CO₂ concentrations (\approx 400 ppm) and high humidities (20 mmol/mol). So, diurnal pressure variations should not be a concern.
- **Chemicals:** Reduced internal chemical effectiveness will affect the span, but the effect on the zero will be much more pronounced. In summary, span stability is mostly a concern with H₂O, when there are large temperature changes.

Note: Read the technical note called "Using CO₂ and H₂O Scrubbers with LI-COR Gas Analyzers" for information about the interactions between scrub chemicals and the air. See <https://boxenterprise.net/s/7i418s3uhd2uamoxfmjd>.

Checking the Zero

Flow a dry CO₂-free air through the optical path and check the analyzer reading in the software dashboard. A suitable source of air for setting the zero can be generated with chemical scrubbers (such as soda lime for removing CO₂ and magnesium perchlorate or Drierite® for removing water), or obtained from a cylinder of zero-grade gas.

When using chemical scrubbers, make sure that the chemicals are fresh and that air goes through the chemicals in the right order: Soda lime first, desiccant last (if the desiccant is Drierite®, allow time for the CO₂ to "wash out" of it). Use a small pump to draw the air through the gas analyzer.

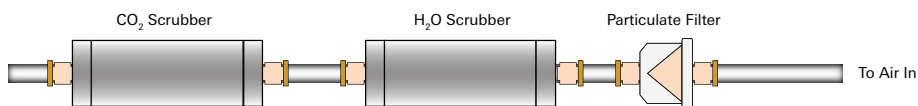

When using a cylinder, make sure that the air in the cylinder really is CO₂-free since a typical cylinder of standard grade nitrogen might have as much as 20 ppm of CO₂ in it. Compressed cylinders may be at pressures of several thousand pounds per square inch; before using them for calibration, they should be fitted with a regulator to reduce the pressure down to a range of around thirty pounds per square inch. Set the flow rate from 0.5 to 1.0 lpm.

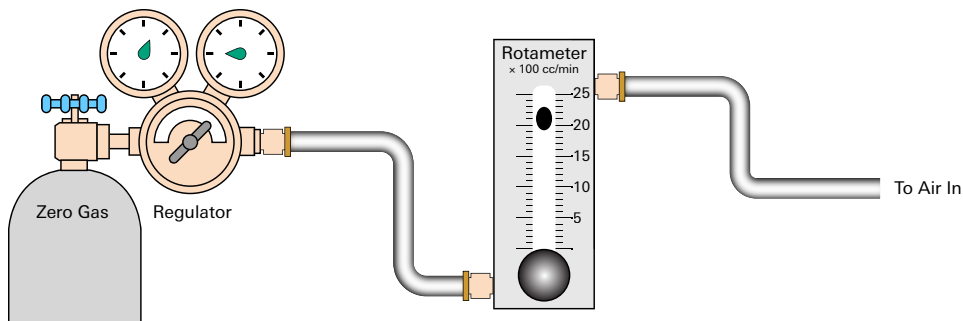

Note: Read the technical note called "Using CO₂ and H₂O Scrubbers with LI-COR Gas Analyzers" for information about the interactions between scrub chemicals and the air. See <https://boxenterprise.net/s/7i418s3uhd2uamoxfmjd>.

Checking the Span

Check the CO₂ span with a cylinder of CO₂ in air at a concentration that is at the higher end of the range of concentrations which may be encountered during measurements. For example, a 500 to 1000 PPM cylinder of CO₂ in air, which has been verified to be accurate to within at least 1% would be a suitable choice for many applications. Be cautious, as the stated value of the calibration cylinder may be significantly different from the actual gas concentration. Set the flow rate to 0.5 to 1.0 lpm. Check the analyzer reading in the software dashboard.

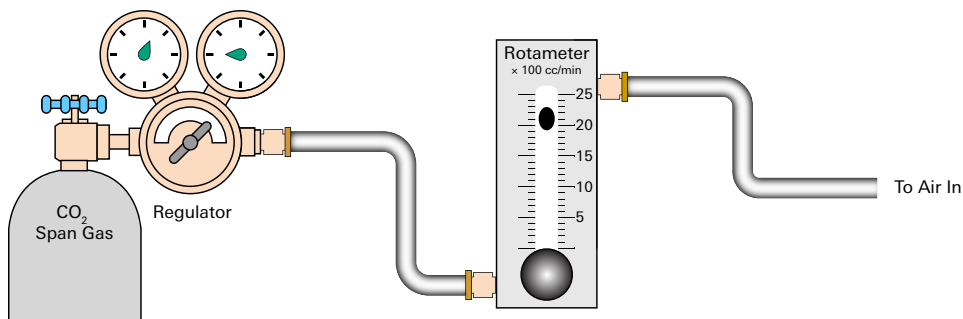

For the water vapor span, a convenient standard to use is a dew point generator such as the LI-COR LI-610. To avoid condensation problems choose a dew point

temperature that is about 3 to 5 °C below the ambient temperature. Also, since water vapor sorbs and desorbs from surfaces, allow plenty of time for the reading to stabilize. Set the flow rate from 0.5 to 1.0 lpm. Check the analyzer reading in the software dashboard.

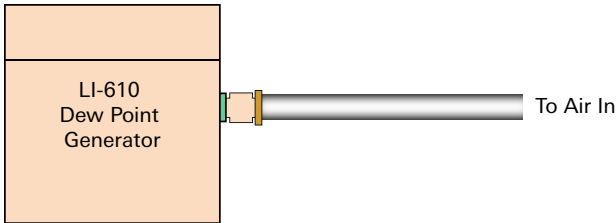

Note: In general, if reliable calibration standards are not available or if there is not enough time to do the job properly, it is better to leave the zero and span settings alone than to rush through the procedure and make incorrect settings.

Span is a linear function of absorbance (see equation 8-8), so there is an offset term and a slope term. Both are determined at the factory, and when a (normal) span is set by the user, only the offset term changes. The slope term can be changed by performing a secondary span at a much different concentration than the previous (normal) span.

Step-by-Step Calibration Instructions

1. Clean the LI-7500RS lenses using a soft, lint-free cloth and mild detergent if needed.
2. Disconnect the temperature thermistor at the **Sensor** connector on the LI-7550 connector panel and connect the cable from the calibration shroud.
3. Insert the calibration shroud into the analyzer. Insert the top of the fixture through the widest opening in the struts, near the bottom window. Slide it up, and then slide the bottom into place. It is important that the fixture is centered between the source and detector windows. View the CO₂ Signal Strength while centering the fixture. If the CO₂ Signal Strength value increases when the fixture is in place, it indicates that one or both of the windows are partially or totally obscured. Move the fixture back and forth until the CO₂ Signal Strength value reads the same as before the fixture was inserted. The fixture is easy to center; if it looks centered, it probably is.

4. Flow CO₂-free air through the calibration accessory at a rate of about 0.5 to 1.0 LPM. Attach the zero gas to the calibration fixture at one of the ports shown in *Figure 4-1* above. The calibration accessory has quick connect fittings for use with standard 1/8" I.D. Bev-a-line (or other) tubing.



Figure 4-1. Flow calibration gas into the calibration fitting. Attach a 15 cm (6 in.) piece of tubing to the outlet to prevent diffusion of ambient air into the calibration fitting.

Zero CO₂

Important: Always zero the instrument before spanning (don't span, then zero).

5. In the PC software, click **Calibration** under the LI-7500RS button.
- Verify that temperature reading looks OK by checking its value in the dashboard.
6. Click on the **Manual** tab and view the value of Z_{CO_2} (CO₂ Zero).
7. Click the **Zero** tab.

When the reading has stabilized in the dashboard, and the **Gas Stability** flag is green, click **Zero CO₂** to set the CO₂ zero.

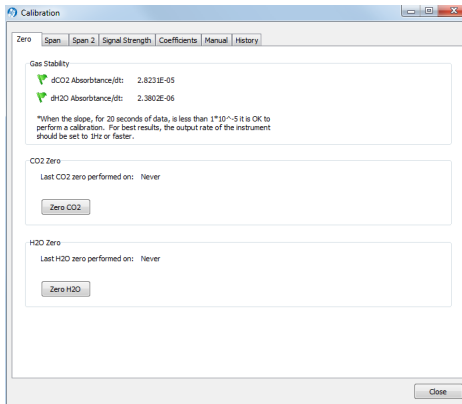

After a brief delay, the displayed CO₂ value should be fluctuating around zero. Check the value of Z_{CO_2} shown on the **Manual** tab. It should be near 1 (typically between 0.85 and 1.1). This value will steadily increase over time (2-3 months) as the internal chemicals lose effectiveness.

Zero H₂O

Now is a good time to check or set the H₂O zero, if you have been flowing dry, CO₂-free air through the optical path.

8. Click the **Manual** tab, and note the present value of Z_w (H₂O Zero).
Wait for the H₂O reading to stabilize in the dashboard (3 or 4 minutes). The **Gas Stability** flag will turn from a red 'X' to a green flag when it is OK to perform the calibration.
9. Click the **Zero** tab, and click **Zero H2O**. Note the new value of Z_w (typically between 0.65 and 0.85).

Span CO₂

10. Flow a CO₂ span gas through the calibration tube at 0.5 to 1 liter/minute.
11. Click on the **Span** tab and enter the mole fraction in the **Span gas concentration** field.
12. When stable (1-2 minutes) click **Span CO2**.
Click the **Manual** tab and check the new CO₂ Span value S_c (typically 0.9-1.1).

Span H₂O

13. To set the H₂O span, flow air of known dew point through the calibration tube at about 0.5 to 1.0 LPM.
To prevent condensation, use a dew point temperature several degrees below the ambient temperature.
14. Click the **Manual** tab, and note the present value of the H₂O Span value S_w .
Go back to the **Span** tab and enter the span gas dew point temperature in the **Dew point temperature** field.
15. Observe the H₂O dew point in the dashboard and wait for it to stabilize.
The **Gas Stability** flag will turn from a red 'X' to a green flag when it is OK to perform the calibration. *This may take up to 15 or 20 minutes.*
16. When the reading has stabilized, click **Span H2O**.
Click the **Manual** tab again and note the new H₂O Span value S_w (typically 0.9-1.1).

Considerations for Setting the Secondary Span

If you find that after zeroing then spanning at one concentration, the instrument is not within specifications at a different concentration, a secondary span may be in order. The most common reason for doing this would be after a change in the chopper housing temperature set point (see *Advanced—Chopper Housing Temperature* on page 7-7). The two gas concentrations used for the span and secondary span should be as far apart as possible. For example, at the factory, this is typically done for CO₂ using 200 ppm and 3000 ppm. At a minimum, the pair should be at least 500 ppm apart, and bracket your intended operating range (e.g. 300 ppm and 800 ppm). For H₂O, you are constrained by the temperature of the air. You would normally choose a very low dewpoint, such as 5 °C, and something close to (just below) ambient. If the air temperature is 15 °C or less, you should probably avoid doing a secondary water vapor span.

Step-by-Step Secondary CO₂ Span

1. Zero the CO₂ reading (see *Zero CO₂* on page 4-6).
2. Span the CO₂ reading at a concentration below your normal operating range (something in the 200-300 ppm range, see *Span CO₂* on the previous page).
3. Flow a CO₂ concentration that is at or above your upper operating range (above 800 ppm, for example).
4. Click on the Span 2 tab, and when stable, click **Span 2 CO₂**.

NOTE: You can reverse the concentrations if you wish. The normal span can be the high concentration, and the secondary the low concentration. Also, multiple secondary spans can follow a normal span. Simply make sure that the concentration difference between the normal span and any secondary span is large.

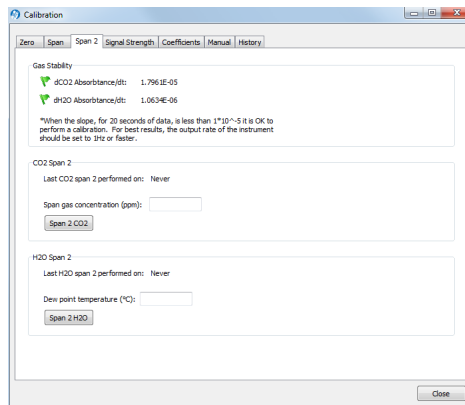

Step-by-Step Secondary H₂O Span

1. Zero the H₂O reading (see *Zero H₂O* on page 4-7).
2. Span the H₂O reading at a dew point that is just below the ambient temperature (see *Span H₂O* on page 4-7).
3. Flow a very low dew point through the tubing.
4. Click on the Span 2 tab, and when stable, click **Span 2 H₂O**.

It may take another 10 minutes or so to ensure equilibrium is reached when changing from one concentration to another, due to water present in the tubing, etc.

NOTE: You can reverse the concentrations if you wish. The normal span can be the high dew point, and the secondary the low dew point. Also, multiple secondary spans can follow a normal span. Simply make sure that the concentration difference between the normal span and any secondary span is large.

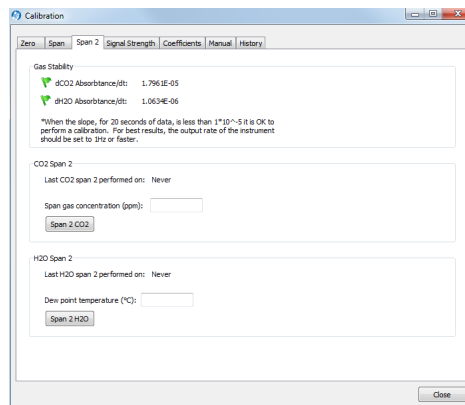

What Actually Happens

In the LI-7500RS the zero and span parameters are set in software (see *Manual Tab* on page 7-23). What actually happens when the zero is set is that the value of Z_{c0} (or Z_{w0} for water) is determined. For example, when CO₂-free air is in the optical path of the analyzer, α_c should be 0. From equation 8-17,

$$\alpha_c = 0 = \left(1 - \left[\frac{A_c}{A_{c0}} + X_{wc} \frac{A_w}{A_{w0}} \right] \right) (Z_{c0} + Z_c V_d) \quad 4-1$$

so

$$Z_{c0} = \frac{1}{\frac{A_c}{A_{c0}} + X_{wc} \frac{A_w}{A_{w0}}} - Z_c V_d \quad 4-2$$

Similarly,

$$Z_{c0} = \frac{1}{\frac{A_c}{A_{c0}} + X_{wc} \frac{A_w}{A_{w0}}} - Z_c V_d \quad 4-3$$

When the span is set, the value of S_{c0} (or S_{w0} for water) is determined. For example, if there is a known CO₂ density ρ'_c in the optical path and the measured absorbance is α'_c , then from equations 8-18 and 8-8, we can write

$$\rho'_c = P_{ec} f_c \left(\frac{\alpha'_c (S_{c0} + S_{c1} \alpha'_c)}{P_{ec}} \right) \quad 4-4$$

so

$$S_{c0} = \frac{P_{ec} f_c^{-1} \left(\frac{\rho'_c}{P_{ec}} \right)}{\alpha'_c} - S_{c1} \alpha'_c \quad 4-5$$

We rewrite this in terms of a known mole fraction m'_c instead of density.

$$S_{c0} = \frac{P_{ec} f_c^{-1} \left(\frac{m'_c P}{P_{ec} RT} \right)}{\alpha'_c} - S_{c1} \alpha'_c \quad 4-6$$

If we assume that the CO₂ span gas is dry, then $P_{ec} = P$, so

$$S_{c0} = \frac{P f_c^{-1} \left(\frac{m'_c}{RT} \right)}{\alpha'_c} - S_{c1} \alpha'_c \quad 4-7$$

Similarly, for a known H₂O mole fraction m'_w and resulting measured absorbance α'_w ,

$$S_{w0} = \frac{P f_w^{-1} \left(\frac{m'_w}{RT} \right)}{\alpha'_w} - S_{w1} \alpha'_w \quad 4-8$$

Whenever the CO₂ span is set, the instrument saves two values that are used if and when a secondary CO₂ span is performed. These values are

$$I_c = Pf_c^{-1} \left(\frac{m'_c}{RT} \right)$$

$$A_c = \alpha'_c \quad 4-9$$

When a secondary span for CO₂ is performed at a mole fraction m'_c with measured absorbance α'_c , then the span slope term S_{c1} is computed from

$$S_{c1} = \frac{Pf_c^{-1} \left(\frac{m'_c}{RT} \right) - \frac{I_c}{A_c}}{(\alpha'_c - A_c)} \quad 4-10$$

A new offset term S_{c0} is then computed using equation 4-7, since the slope term S_{c1} has changed. Similarly, for H₂O, each time a normal water span is set, the instrument retains

$$I_w = Pf_w^{-1} \left(\frac{m'_w}{RT} \right)$$

$$A_w = \alpha'_w \quad 4-11$$

and when a secondary H₂O span is performed at water mole fraction m'_w with measured absorbance α'_w , then the span slope term is computed from

$$S_{w1} = \frac{Pf_w^{-1} \left(\frac{m'_w}{RT} \right) - \frac{I_w}{A_w}}{(\alpha'_w - A_w)}$$

and a new offset term S_{w0} is computed from equation 4-8.

Section 5. Maintenance

The section describes maintenance procedures. A good maintenance plan will ensure good performance of the instrument, reduce data gaps, and give you greater confidence that the measurements truthfully represent physical processes. FluxSuite Software can help immensely with your maintenance plan.¹

Schedule

When you first deploy the instrument:

Check the signal strength and record this for a baseline. This will help you determine when the optics should be cleaned.

Every day or every few days:

Check the overall performance of the instruments, including the measured values and diagnostic information. This will ensure that you don't lose data (or that you lose less data) if something is wrong.

Check the measured values. Air temperature, pressure, sonic temperature, dew point, gas concentrations, covariances and fluxes. Any unexpected readings may indicate an issue.

Check the diagnostics. Signal strength, detector temperature, chopper housing temperature, and thermocouples.

Once per week:

Check the signal strength. There is no absolute guideline for good or bad signal strength, but 100% is very good and 0% is very bad. If the signal strength has dropped it is a good idea to clean the optics. Over time you'll learn how often you need to check the signal strength. Typically it is much less often than once per week.

¹Please forgive this shameless plug. But do check out www.fluxsuite.com.

Once per month:

Check the zero and span. As you become familiar with your instrument, you will probably find that this does not need to be checked as often.

Clean the upper and lower windows of the analyzer.

Download all your data and store it to an archive.

Check cables for damage. Tighten any loose cable connections.

Every six months:

If your instrument is in a humid environment, replace the head chemicals.

One per year:

Replace the head chemicals.

Every two years:

Check the instrument calibration with one or more span gases. If it is outside the specifications, return the instrument to LI-COR for recalibration.

Cleaning the Optical Path

The LI-7500RS optical windows should be cleaned when necessary (visible dirt or stains, or smaller than expected CO₂ Signal Strength).

The windows are sapphire, and are extremely durable and resistant to scratches; clean the windows with any mild detergent or glass cleaner. Also, coating the windows with a water resistant windshield type coating (such as Rain-X®) or a high quality automobile type wax may help prevent droplets from remaining on the windows during rainstorms. Mounting the sensor head at a slight angle from vertical (~10-15°) may also help prevent water droplets from



Figure 5-1. Water on the sapphire windows can cause low signal strength (formerly AGC) values.

remaining on the windows during rainstorms.

The sensor head shown below in *Figure 5-1* on the previous page is from a long term test on a roof top on a snowy day (January 2001) in Lincoln, NE. Note the small puddle of water on the sapphire window. The signal strength was near 0.

Replacing the Fuses

Early models of the LI-7550 have one fuse for the power supply. Later models have two fuses—one for the power supply and one for the accessory. To check a fuse, inspect it for evidence that it is burned and use an ohm meter to check the resistance. Resistance of $<1 \Omega$ (ohm) indicates that the fuse is OK.

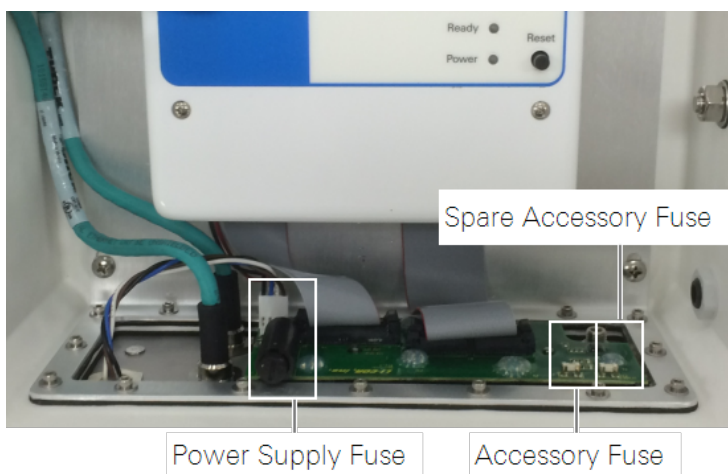

Figure 5-2. LI-7550 fuse locations.

Power Supply Fuse

The LI-7500RS power supply is protected by a 5 A 125/250V, 5×20 mm fast-blow fuse (part number 439-04214). If the battery or other power source fails to power the LI-7500RS, check to see if the fuse has blown.

The fuse is located in the lower left-hand corner, as shown in *Figure 5-2* above. Replacement fuses (part number 439-04214) are in the spares kit. Use a flat blade screwdriver or your thumb to push down on the fuse holder cap and turn counterclockwise to release the cap.

Accessory Fuse

The accessory uses a 2 A Nano² SMF Fuse. There is one spare fuse included in the LI-7550. If the heated intake tube will not power on or continuously triggers an error, check the fuse and replace it if necessary.

Replacing the Internal Chemicals

There are two small plastic bottles, each containing Ascarite II and magnesium perchlorate, in the analyzer housing that keep the optics free of CO₂ and water vapor. These bottles should be recharged with fresh chemicals annually (or every 6 months in hot, humid climates). Replacement "charged" bottles are available from LI-COR in sets of two (part number 7500-950). If you want to recharge the bottles yourself, see *Suppliers* on page C-1 for a list of suppliers of Ascarite II and magnesium perchlorate.

NOTE: Calibration shifts will occur if CO₂ or H₂O are not kept out of the analyzer housing.

To change the sensor head soda lime and desiccant bottles:

1. Remove the chemical bottles.

The plastic bottles are in the lower analyzer housing in the sensor head. Remove the mounting bracket from the analyzer. Then remove the thumbscrew and thread it into a cap. Pull straight out to remove the plug.



2. Fill the bottles half full with Ascarite II first, followed by the magnesium perchlorate.
3. Place the Teflon membrane in the lid to keep the chemicals from spilling.

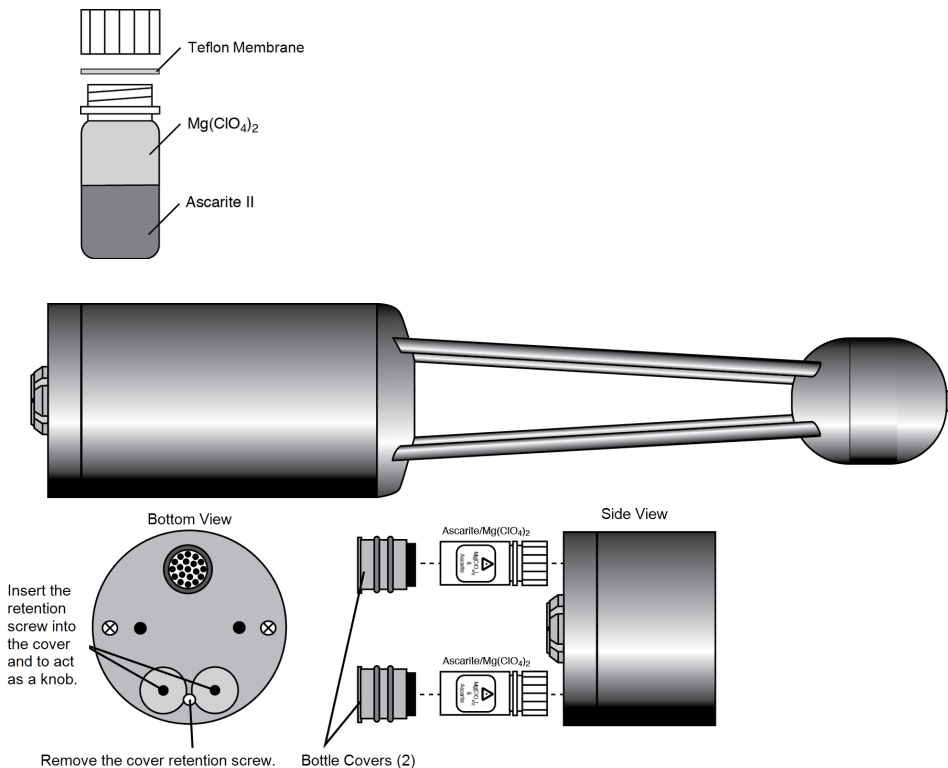

Figure 5-3. Remove the thumbscrew, thread into the bottle covers, and pull to remove the bottle cover.

4. Insert the recharged bottles into the analyzer housing cap first. Replace the bottle covers and the cover retention screw and reattach the mounting bracket.
5. After installing, **allow at least 24 hours (with the instrument powered on)** to scrub the housing; otherwise, the instrument may still drift.

This should be followed by setting the CO₂ and H₂O zeros. Check the zero again, if possible, after one or two days.

Note: Read the technical note called "Using CO₂ and H₂O Scrubbers with LI-COR Gas Analyzers" for information about the interactions between scrub chemicals and the air. See <https://boxenterprise.net/s/7i418s3uhd2uamoxfmjd>.

Section 6. Troubleshooting

We address common problems in this section.

Power On Problems

Adequate power supply? The instrument requires between 11.5 and 30 VDC (up to 30 W) to start up and 10 to 30 VDC (about 10 W) during normal operation. If the **Power** LED blinks the power supply is not sufficient to start up the instrument. Measure the voltage at the 4-pin connector inside the LI-7550 (rather than the voltage at the battery bank). The blue/black leads are positive (+), the brown/white leads are negative (-). If voltage at the connector is below 11.5 VDC, shorten the length of the power cable if possible, or boost the voltage.

Loose connection? Make sure the power cable connector is tight. Also check the cable for damage and the connections to the power supply.

Blown fuse? Check the fuse, as described in *Replacing the Fuses* on page 5-3. Note that a blown fuse usually indicates some other problem. If the fuse blows repeatedly, carefully check the wiring.

Ethernet Connection Problems

Most Ethernet problems are related to firewalls or network settings.

Instrument not visible in software

Firewall rules prohibiting the connection? Attempt to connect to the gas analyzer using the RS-232 connection. If you are able to connect as expected, the problem may be related to your computer firewall settings. In this case, you'll need to create an exception that allows the gas analyzer through the firewall. If you are using the Windows® firewall, follow the instructions provided by Microsoft® at windows.microsoft.com/en-us/windows/open-port-windows-firewall. If you are using another firewall, refer to documentation provided with that software.

Instrument network settings incompatible with computer or local area network settings? If the instrument IP address is set to **Static**, you probably will not be able to connect to the instrument over a network unless you change the instrument IP address to **Dynamic** (Obtain IP address automatically). See *Network* on page 7-4. Alternatively, connect to the instrument using the RS-232 serial connection.

RS-232 serial connection problems

When connecting with RS-232 serial, the **Connect** button in the PC software causes the program sets a break condition on the communication line, signaling the instrument to change to 9600 baud and send its current configuration. The PC then sends the desired configuration (update rate, baud rate, etc.) back to the instrument. Both instruments then change to the desired baud rate, and operations begin. When the **Disconnect** button is clicked, the PC signals to the instrument to change its RS-232 configuration back to what it was originally (or to that set up in the RS-232 panel).

"Port in use or does not exist"

Correct COM port selected? This message indicates that the COM port setting on the **Connect** page is either incorrect, or else that COM port is already in use by some other program. If you are sure that the COM port is correct, and there is nothing else running, try rebooting the instrument.

"Not able to connect successfully"

Click **Connect** again. Sometimes it takes a couple of attempts. If repeated attempts fail, then make sure the correct COM port is selected. Make sure the instrument is powered and running and see if the LED lights for about 5 seconds.

"Parse Error"

Incompatible PC and instrument software? Install new PC and instrument software (see *Software Updates* on page 7-33).

Baud rate and update rate incompatible? In the **Connect** window, the Baud Rate menu is used to set the baud rate at which to communicate with the instrument. The rate of data transfer is also dependent upon the maximum rate available with

your computer's serial port, and the update frequency to be used while the program communicates with the instrument.

The **Update Rate** is the update frequency to be used while the PC software communicates with the instrument. Select from 0.1, 0.2, 0.5, 1, 2, 5, 10, or 20 Hz. **At 9600 baud, the maximum update frequency is 2 Hz; at 19200 baud, 5 Hz; at 38400 baud, 10 Hz; at 57600 baud, 15 Hz; and at 115200 baud, 20 Hz.**

Use a faster Baud Rate and/or a slower Update Rate to resolve this problem.

Instrument software is unresponsive

Incompatible PC and instrument software? Make sure that your PC software and instrument embedded software are compatible. Yellow indicators in the **Connect** dialog box are displayed when the instrument (embedded) software version is incompatible with the PC software. Green indicators are displayed when instrument and PC software are compatible. See *Software Updates* on page 7-33.

Reboot needed? The instrument can be rebooted using the **Reset** button on the LI-7550 control panel. Pressing the Reset button restarts the boot process; if connected via Ethernet, the instrument will attempt to reconnect to the PC software. If connected via RS-232, you may need to restart the PC software and reconnect manually.



Figure 6-1. Reset button in the LI-7550.

Bad Temperature Readings

Temperature sensor connected? Be sure that the sensor is connected to the LI-7550.

Bad Pressure Readings

Pressure source set incorrectly? You can select the source of pressure measurements, as described in *Auxiliary Inputs* on page 7-10. If the source is **Measured**, the readings come from the pressure sensor inside the LI-7550. If the source is **Auxiliary Input 2**, then the pressure is from an external sensor that you have connected. This signal is modified according to the Auxiliary Coefficients that appear on that same page. If the source is **User-Entered**, then whatever you enter manually in the text box is used for the value.

Instrument pressure doesn't match your barometer? The pressure sensor in the LI-7550 is good to about 0.1%. For operating purposes, it doesn't need to be very good (see *A Note About Pressure And Temperature* on page 8-7). When setting the span(s) of the instrument, however, it is more important.

Bad CO₂ or H₂O Readings

Calibration coefficients correct? Make sure all of the coefficients on **LI-7500RS > Calibration > Coefficients** match the calibration sheet for the head. You can get your calibration information from the LI-COR web site. The Band Broadening coefficient should be 1.15.

Signal strength OK? Under the **Diagnostics** page and check the values of **Signal Strength**. Even if the signal strength is good, you may need to clean the optical windows.

Are any of the diagnostic flags (PLL, etc.) OK? Under **Diagnostics**, check the diagnostics. See *Diagnostic Messages* on page 7-25 for more information.

Zero and Span OK? Go to the **Calibration** page and make sure the current values of zero and span are near 1.

Absorptances Make Sense, Densities Don't

If the absorptance value seems correct (rough rule of thumb: absorptance = 0 when density = 0, CO₂ absorptance is about 0.1 with a mole fraction of about 400 ppm, and H₂O absorptance is about 0.1 with a mole fraction of about 20 mmol/mol), but the displayed values of density or mole fraction are obviously bad, then the problem

is in one of the following: calibration coefficients, span parameter, pressure value, and the band broadening value (CO₂ only).

Readings Very Noisy

Put the calibration tube in place to dampen the natural fluctuations. You don't need a gas flowing through the tube. The variability in absorptance values should be low, with only the 4th decimal place changing once in a while. If density or mole fraction is still noisy, watch the temperature and pressure values to see if they are the source of the noise (or change to a hand entered, constant value to try this). Check the calibration coefficients and band broadening value (if the problem is with CO₂) to make sure they are correct.

Section 7. Software Reference

This section describes features that have not been described elsewhere.

Settings



Under **Settings**, you can set the instrument time, network configuration, send commands, change the chopper housing temperature set point, and integrate CO₂ measurements.

Time

This is where you set the instrument time and date. The clock in the LI-7550 Analyzer Interface Unit uses the Precision Time Protocol (PTP) time keeping system. PTP is a high precision time synchronization protocol for networked devices. Devices controlled with PTP can maintain accuracy in the sub-microsecond range with a sufficiently accurate master clock. PTP is defined in the IEEE 1588-

2002 and 1588-2008 standards, entitled “Standards for Precision Clock Synchronization Protocol for Networked Measurement and Control Systems.” A detailed summary of IEEE-1588 is available at www.ieee1588.com. Full documentation is available for purchase from the Institute of Electrical and Electronics Engineers (IEEE) at www.ieee.org.

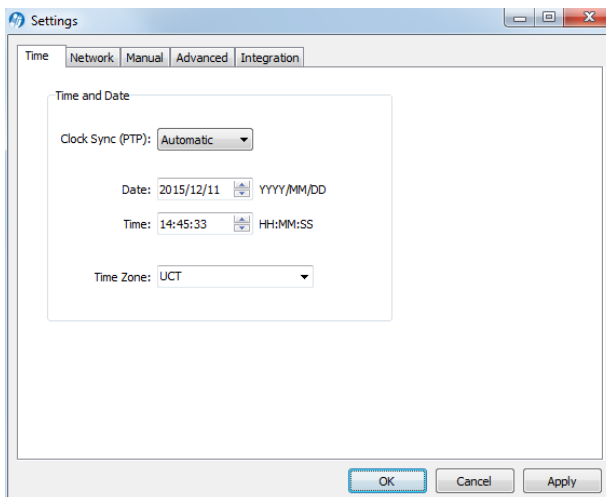

The basic principle behind PTP is that the best time keeping can be accomplished with multiple networked devices by synchronizing all device clocks to the most precise clock on the network. Each clock on the network has a rating that indicates its relative accuracy. The IEEE 1588 protocol specifies the use of a Best Master Clock algorithm to determine which clock on the network is the most accurate. On a network, the most accurate clock becomes the master clock and all other clocks sync to the master clock.

The software implementation of PTP in the LI-7550 provides accuracy in the 10 microsecond range. Implementation of PTP is most important when the LI-7550 is used in combination with other network-based sensors such as the LI-7700 Open Path CH₄ Analyzer. When used with the SMARTFlux System, the GPS clocks will become the master clock for the system.

About LI-7500RS Time Keeping

The LI-7500RS is a network-based instrument and it is possible for multiple users to log data from a single instrument over multiple TCP/IP connections via the LI-7550 Analyzer Interface Unit. Consequently, the analyzer uses Coordinated Universal Time (UTC) for its onboard timekeeping tasks. The default time stamp is therefore UTC based, but local time can be set, if desired.

Generally, we recommended that the system synchronizes its time the GPS clocks. The LI-7500RS uses a time zone database that includes local time zones that are kept as constant offset from UTC. These time zones are listed as 'Etc/GMT' + offset. However, these time zone names beginning with 'Etc/GMT' have their sign reversed from what is commonly used. Thus, zones west of GMT have a positive sign, and those east have a negative sign. For example, US/Central Standard Time is 6 hours behind GMT, and in the database this time zone is listed as 'Etc/GMT-6'.

Unix time is the number of seconds elapsed since the Unix epoch of 00:00 Coordinated Universal Time (UTC) January 1, 1970 (or 1970-01-01T00:00:0Z ISO 8601). For example, the time stamp 1262884605 translates to 01/07/2010 at 05:16:45 UTC. The date and time are converted to a conventional display format (YYYY-MM-DD; HH:MM:SS) and adjusted based on the time zone setting that you select.

The time stamp in each file header shows the instrument time and time zone.

Setting the Clock

1. Connect to the LI-7500RS.
2. Open the Settings dialog box.
3. Set the Clock Sync (PTP).
4. Choose your time zone.
5. Click **Apply** or **OK**.

The PTP clock settings available are:

- **Off:** Turns PTP time keeping system off. Instrument time will be determined by the Date and Time set by the user, even if there is a better clock on the network.
- **Automatic:** The LI-7550 searches the network and syncs to the most accurate clock using the Best Master Clock algorithm (could be LI-7550). This setting should be used in most circumstances.
- **Slave Only:** The LI-7550 always syncs to another clock. It will search the network and synchronize to the best clock.
- **Preferred:** The LI-7550 uses its own internal clock unless it finds a better clock on the network.

When connecting the LI-7500RS/LI-7550 to the LI-7700 CH₄ Analyzer (see *Entering LI-7700 Information* on page 3-30), or to the 9210B datalogger (see *Entering Biomet System Information* on page 3-33) we recommend that you set the LI-7550 to Preferred, and the LI-7700 and/or 9210B to Automatic.

Network

By default, the instrument name that appears in the Ethernet Connect dialog is the Analyzer Interface Unit prefix and its associated serial number (e.g., AIU-0650). You can change this name in **Settings > Network**.

The **IP address** (Internet Protocol) is a numerical identifier that is assigned to devices participating in a computer network. In many cases this address is assigned automatically (Dynamic IP address). In other cases, your network administrator may assign a permanent address (Static IP address) that can be entered manually.

If you enable the ‘Obtain an IP address automatically’ radio button, the IP address, Subnet mask, and Default Gateway fields are filled in automatically; if you choose to enter the IP address manually, the address fields are editable.

The **Subnet mask** is a set of 4 octets used to separate an IP address into two parts; the network address and the host address. The **Gateway** is a node that routes traffic to another network.

Manual Addressing

Alternatively, you can manually enter the IPv4 Address or Hostname (if known) of the instrument to which you want to connect. The IP address can be obtained automatically or assigned manually in the Settings dialog box. If IPv6 (Internet Protocol version 6) addressing is available on the network and enabled on the computer, the instrument’s IPv6 address is displayed as well.

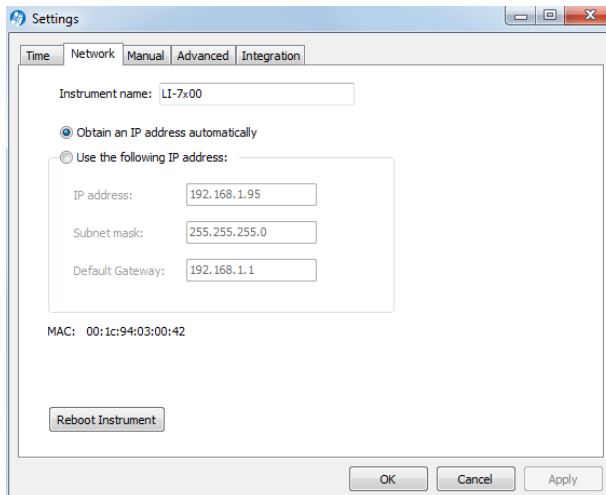

The LI-7500RS use the **Port** number 7200 for Ethernet communications. Therefore, when connecting to the instrument on a network you will enter the IP address of the instrument and port 7200 in the connection dialog of the application software to initiate communication. You can select the instrument from the list of instruments on the same network as your computer or connect your computer directly to the instrument Ethernet port.

Port Forwarding

In some network setups it may be necessary to forward communication traffic on a port from a public IP address to a private IP address to gain access to an instrument. For example, assume you have an LI-7500RS installed in the field and the instrument is connected to a wireless gateway such as a cellular modem. The instrument will acquire a **private** IP address from the cellular modem, but this address is only visible to nodes on the private network. On the other hand, the cellular modem is assigned a public IP address that can be accessed from any node on the Internet. For this discussion let’s assume the public address is 166.66.77.88. In order to connect to the instrument in the private network, a port forwarding rule must be created in the cellular modem to “forward” all communications on port 7200 coming into the modem to the private IP address of the instrument.

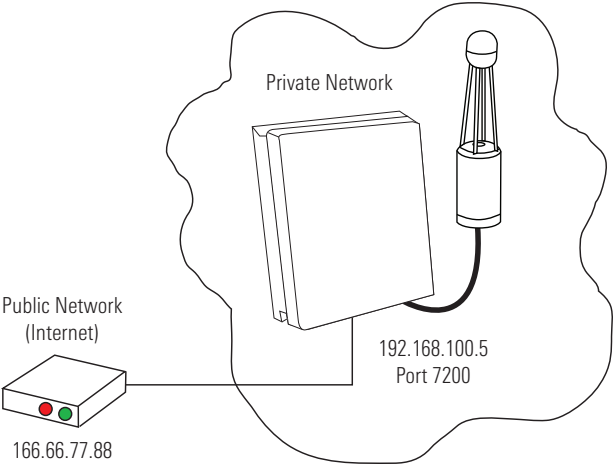

Instrument	Public IP	Public Port	Private IP	Private Port
1	166.66.77.88	7200	192.168.100.5	7200

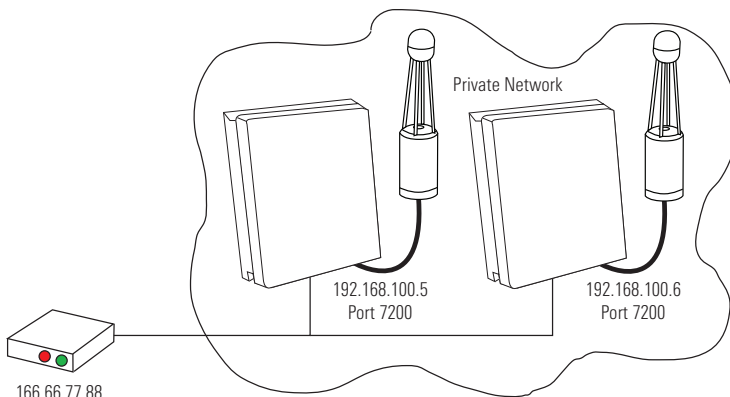

The public port number should be changed when there is more than one LI-7200RS or LI-7500RS in the private network. In this case, to connect to each instrument, two port forwarding rules must be set up, similar to that shown below.

Instrument	Public IP	Public Port	Private IP	Private Port
1	166.66.77.88	7201	192.168.100.5	7200
2	166.66.77.88	7202	192.168.100.6	7200

You can run multiple LI-7500RS software sessions at the same time to communicate with different analyzers. Simply double-click on the software icon to open another session, and connect to a different instrument.

Manual

A command line field is present that allows you to send a command to the LI-7500RS. This can be useful for diagnosing problems, as a LI-COR technician can gauge the instrument's response to given commands, and determine if the instrument is functioning properly. Contact LI-COR technical support for details on the grammar.

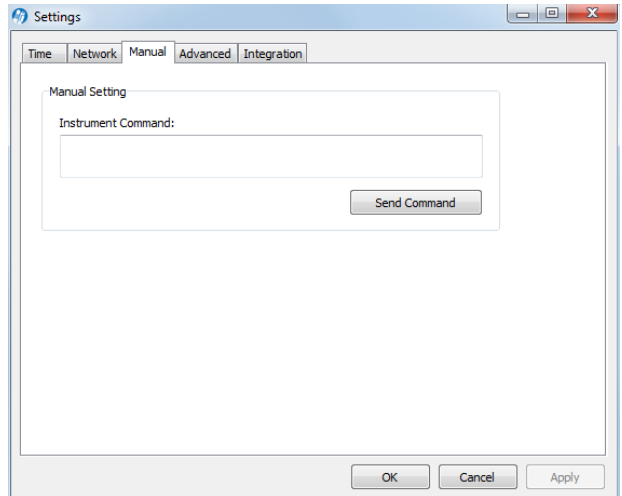

Advanced—Chopper Housing Temperature

The chopper motor housing temperature can be set to a lower operating temperature (5 °C) in winter to reduce power consumption. Note, however, that the instrument will still function properly when the chopper motor housing temperature is set to 30 °C, even when temperatures are below 5 °C.

Do not set the chopper housing temperature to 5 °C when ambient temperatures are above 5 °C, however, as the instrument will not function properly.

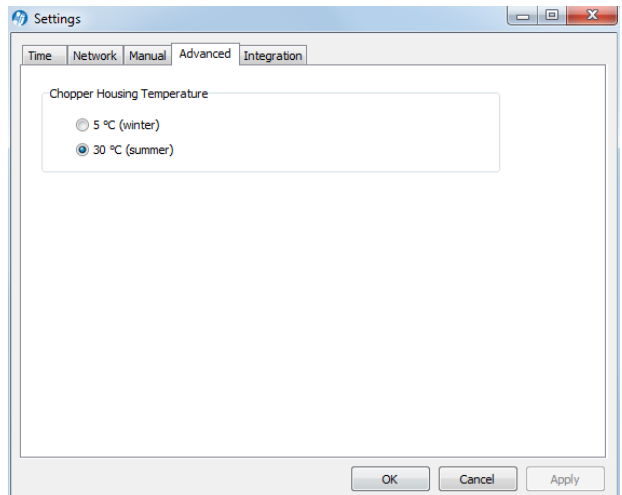

IMPORTANT: When changing between winter and summer settings, you will need to perform a zero and dual span calibration, as described in *Calibration Overview* on page 7-21.

Integration

Allows for the setup of an integration function using a selected CO₂ source (mmol/m³ or μmol/mol). The integrated value selected can be viewed as a data source in the main software window (choose **Integral** in the Data Items list). To integrate a CO₂ source:

1. Choose a source to be integrated from the Integration Channel list.
2. Choose the method to start the integration; immediately, or using a threshold value.
3. Choose the method to stop the integration; manually, with a threshold value, or after a user-entered elapsed time (s) has expired.
4. Enter the threshold value for the start or stop (or both) of the integration, if either was chosen in Steps 2 or 3 above.
5. Click on the Apply button.

If Start Immediately was chosen for the Start Time, the integration function is started and/or stopped manually by clicking the $\int dt$ Integration On or $\int dt$ Integration Off buttons (available on the dashboard, as well).

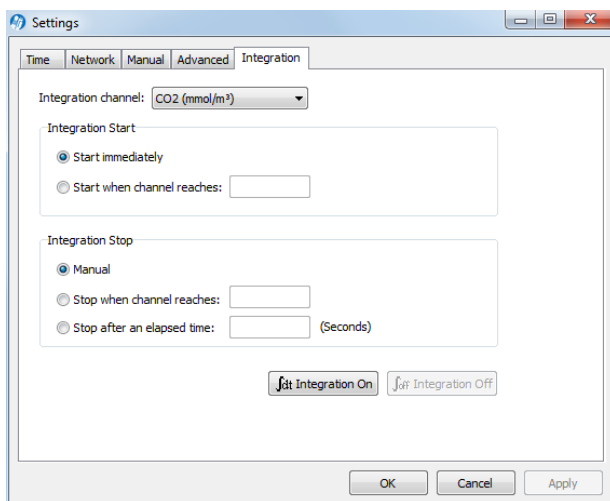

Example: Start integrating CO₂ (μmol/mol) after it reaches a value of 500 μmol mol⁻¹, and continue integrating for 5 minutes.

- 6.** Choose **CO2 (μmol/m³)** from the Integration Channel list.
- 7.** Click the **Start when channel reaches** radio button and enter 500 in the text entry field.
- 8.** Click the **Stop after an elapsed time** radio button and enter 300 (seconds) in the text entry field.
- 9.** Click **Apply**.
- 10.** Click the **Int Integration On** button. Click **OK** to dismiss the dialog.

The integration result (area under the curve) can be viewed in the dashboard.

LI-7500RS Menu Overview

The LI-7500RS menu provides access to **Input...** settings, **Output...** settings, **Calibration...**, and **PC Logging...**

Auxiliary Inputs

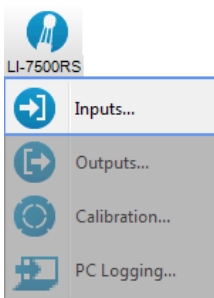

There are three things to configure under **Inputs**:

- **Auxiliary Inputs:** Typically used for sonic anemometer data, this is described in detail in *Configuring the Anemometer Inputs* on page 3-23.
- **Temperature Source:** Specifies whether the temperature source is the instrument, a temperature sensor on Auxiliary Input 1, or a User Entered value.
- **Pressure Source:** Specifies whether the temperature source is the instrument, a pressure sensor on Auxiliary Input 2, or a User Entered value.

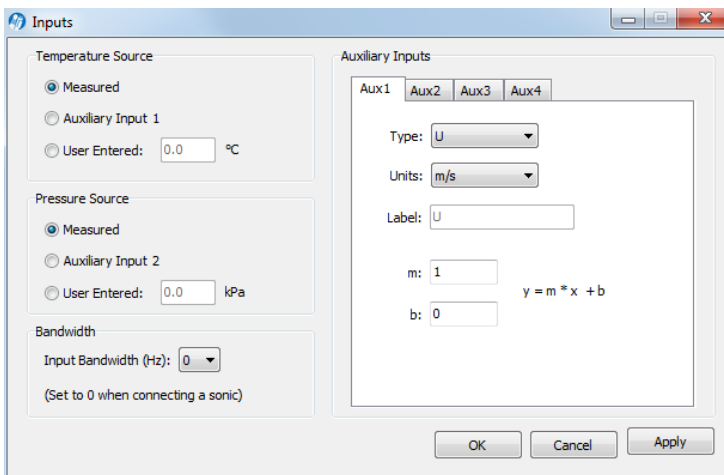

Temperature and pressure values are required to convert CO₂ and H₂O density (mmol/m³) to mole fraction (μmol/mol or mmol/mol). In addition, the analyzer requires a pressure value to compute CO₂ or H₂O mole density, and a temperature value to perform the band broadening correction for H₂O on CO₂.

In eddy covariance applications we recommend that you use temperature and pressure measurements provided by the instrument.

If you use your own temperature and/or pressure sensors, one or two of these channels will be unavailable for anemometric data. If you use the on-board temperature and pressure sensors, all four auxiliary input channels are available for use with other sensors.

Choose **Other** for any sensor input other than a sonic anemometer. The **Units** field describes the data after the coefficients m and b are applied. The **Label** will appear in the header of the data file.

Each auxiliary input channel has two fields for the multiplier (m) and offset (b). Linear voltage inputs (0 to 5 V) use the slope-offset equation:

$$y = m \cdot x + b \quad 7-1$$

where y is the sensor output, x is the voltage output of the sensor, b is the Y-axis intercept (offset), and m is the calibration multiplier, which is the slope of the line representing the sensor's response.

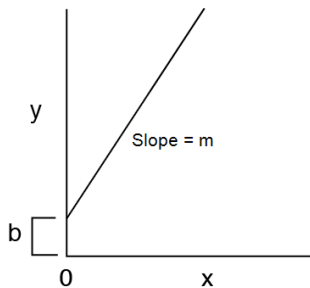

Outputs

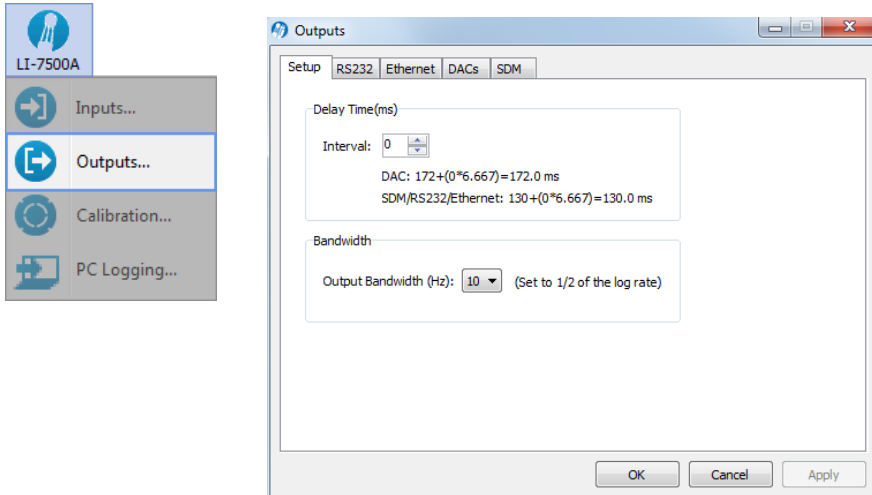

The **Outputs** window allows you to configure the analog output channels, RS-232, Ethernet, or Synchronous Device for Measurement (SDM) outputs.

The **Setup** tab presents **Delay Time** and **Bandwidth** settings that affect all LI-7500RS outputs (RS-232, Ethernet, DACs, and SDM).

Note: The bandwidth selection has no impact on the system delay. The filters were designed so they have exactly the same delay whether a 5, 10, or 20 Hz signal bandwidth is selected.

RS-232 Output

The RS-232 tab is used to set the LI-7500RS RS-232 port configuration for unattended data collection. After configuration, click **Apply**; the LI-7500RS will begin to send data out the RS-232 port according to these parameters after you disconnect from the instrument (or immediately if you are connected via Ethernet).

Use the Baud Rate menu to select from 9600, 19200, 38400, 57600, or 115200 baud.

Use the Update Rate menu to select from .1, .2, .5, 0, 1, 2, 5, 10, or 20 Hz. Note that at lower baud rates, you may not be able to output all data items at high frequencies. For example, at 9600 baud, the maximum update rate is 2 Hz, when outputting all 34 data items.

Note on Data Output Rates

When sending data via a serial connection (e.g., RS-232), note that the baud rate selected may limit the number of samples that can be output. A single line of data (all log values selected) consists of approximately 350 bytes (2800 bits), so the maximum output rate at the available baud rates becomes:

Baud Rate	Maximum Output Rate (Samples per Second)
9600	2
19200	5
38400	10
57600	15
115200	20

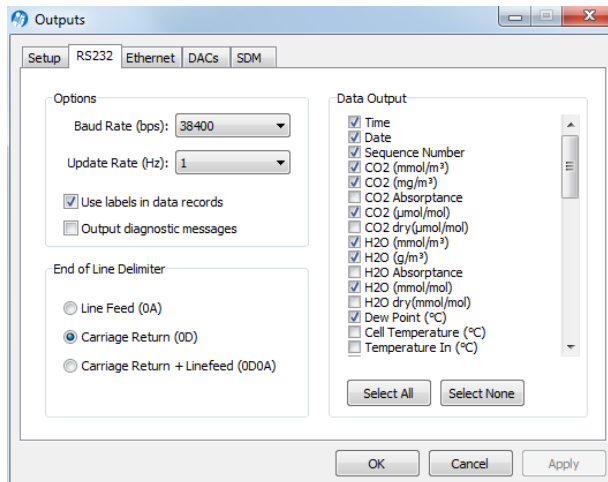

Under **Options**, you can choose whether or not to output labels with each data record, and whether to output diagnostic text records. An example of a data record sent with and without labels is shown below.

Data format with labels:

```
(Data (Ndx 87665) (DiagVal 757) (Date 2009-09-10) (Time
14:06:44:140) CO2Raw 0.0332911) (H2ORaw 0.19299) (CO2D 5.20672)
(H2OD 755.566) (Temp 15.517) (Pres 99.4361)...
```

Data format without labels:

```
87665 757 2009-09-10 14:06:44:140 0.0332911 0.19299 5.20672...
```

The End of Line Delimiters determine the character(s) that terminate the data records. Depending on your recording device, a line feed, carriage return, or both may be required to properly parse the data records.

Under **Data Output**, select the data records that you want to output; click **Select All** to choose all, or **Select None** to disable all checked values.

Ethernet Output

The **Ethernet** tab is used to set the LI-7500RS Ethernet port network communication. After configuration, click **Apply** and the analyzer will begin to send data out the Ethernet port according to these parameters.

Use the **Update Rate** menu to select from .1, .2, .5, 0, 1, 2, 5, 10, or 20 Hz.

Under **Options**, you can choose whether or not to output labels with each data record, and whether to output diagnostic text records. An example of a data record sent with and without labels is shown below.

Data format with labels:

```
(Data (Ndx 87665) (DiagVal 757) (Date 2009-09-10) (Time
14:06:44:140) CO2Raw 0.0332911) (H2ORaw 0.19299) (CO2D 5.20672)
(H2OD 755.566) (Temp 15.517) (Pres 99.4361)...
```

Data format without labels

```
87665 757 2009-09-10 14:06:44:140 0.0332911 0.19299 5.20672...
```

The End of Line Delimiters determine the character(s) that terminate the data records. Depending on your recording device, a line feed, carriage return, or both may be required to properly parse the data records.

Under Data Output, select the data records that you want to output; click **Select All** to choose all, or **Select None** to disable all checked values. The data items available for display given in on page 3-5.

DAC Configuration

The LI-7550 has the capability to output up to 6 variables on DAC channels 1-6. The DACs page allows you to configure the DAC output channels by specifying the source channel (e.g., CO₂ mmol/m³) that drives the analog signal, the source channel value that corresponds to zero volts, and the source channel value that corresponds to full scale voltage (5V).

For example, to configure DAC #1 to output a voltage signal proportional to CO₂ mmol/m³, 20 mmol/m³ full scale, select CO₂ mmol/m³ under DAC1 'Source', and set 0V = 0, and 5V = 20.

$$\begin{aligned} 0V &\rightarrow 0 (X_0, \text{ zero volts corresponds to } 0 \text{ mmol/m}^3) \\ 5V &\rightarrow 20 (X_F, \text{ full scale corresponds to } 20 \text{ mmol/m}^3) \end{aligned}$$

When a voltage range R is selected, the DAC output voltage V resulting from a CO₂ molar value X is given by

$$V = R \frac{X - X_0}{X_F - X_0} \quad 7-2$$

where R = 5V.

The DACs are linear, so in the example above, a measured voltage signal of 3 volts would correspond to a CO₂ mmol/m³ value of 12.

For test purposes, you can also choose **Set Point** for the Source, and enter a Set Point voltage value; the DAC channel will then output that voltage continuously.

LI-7500RS SDM Output

SDM addressing allows multiple SDM-compatible peripherals to be connected to a single Campbell Scientific® datalogger. Choose an address under the SDM tab

between 0 and 14.

SDM communications are enabled in Campbell Scientific dataloggers with one of two instructions, depending on the datalogger. For dataloggers programmed in EdLog (e.g. CR23X) SDM communications are enabled using instruction 189:SDM LI-7500. When using this instruction, parameter two (SDM Address) should be set to match the SDM address of the LI-7500RS. Parameter three (Option) is used to define what variables the datalogger collects from the instrument, and can take on values from 0 to 6 (see table 4-1 for variables included in each option). Below is a programming example of instruction 189 used to collect data from an LI-7500RS at SDM address 0:

```
1: SDM-LI7500 (P189)
    1: 1      Reps
    2: 0      SDM Address
    3: 6      Get CO2 & H2O molar density, pressure,
             and cell diagnostic value
    4: 49     Loc [ LI75000 ]
```

For dataloggers programmed in CRBasic (e.g. CR5000) SDM communications are enabled using the instruction CS7500. When using this instruction, parameter three (SDMAddress) should be set to match the SDM address of the LI-7500RS. Parameter four (CS7500Cmd) is used to define what variables the datalogger collects from the instrument. Unlike instruction 189, the CS7500 instruction supports a group trigger mode, so it can take on values from 0 to 7 (see *Table 7-1* on the facing page for variables included in each option). Below is a programming example of the CS7500 instruction used to collect data from an LI-7500RS at SDM address 0:

```
CS7500 (LI-7500(),1,0,6)
```

Table 7-1. Parameter 3 value definitions.

Mode	Items Sent
0	CO ₂ (mmol/m ³) H ₂ O (mmol/m ³)
1	CO ₂ absorptance H ₂ O absorptance
2	Pressure (kPa) Temperature (°C) Aux channel #1 (user units) Cooler signal (Volts)
3	Diagnostic value (see below) Bandwidth (Hz) Delay interval
4	CO ₂ (mmol/m ³) H ₂ O (mmol/m ³) CO ₂ absorptance H ₂ O absorptance Pressure (kPa) Temperature (°C) Cooler signal (Volts) Diagnostic value (see below) Bandwidth (Hz) Delay interval
5	CO ₂ (mmol/m ³) H ₂ O (mmol/m ³) Pressure (kPa)
6	CO ₂ (mmol/m ³) H ₂ O (mmol/m ³) Pressure (kPa) Diagnostic Value (see below)
7	<u>Trigger Mode</u> CO ₂ (mmol/m ³) H ₂ O (mmol/m ³) CO ₂ Signal Strength Pressure (kPa)

Table 7-1. Parameter 3 value definitions. (...continued)

Mode	Items Sent
NOTES:	<p data-bbox="407 248 1237 345">LI-7500RS Mode 7 requires the Campbell datalogger to broadcast a group trigger to cause data to be registered. The registered data set is held and not updated until the next group trigger.</p> <p data-bbox="407 386 1237 480">All serial transfers on the SDM bus are bit reversed. This means that the least significant bit is sent first and the most significant bit is sent last. This includes sending the signature.</p>

Delay Time

The output signal from the LI-7500RS optical bench is sampled by a high-speed analog-to-digital converter and input into a digital signal processor (DSP). This signal is processed digitally and gas densities are computed from it. There is a fixed delay in this process, and an additional user-programmable delay that can be used to make the LI-7500RS output occur on even sampling intervals.

The LI-7500RS has a fixed throughput delay of 172 milliseconds for the DAC outputs, and 130 ms for the SDM, RS-232, and Ethernet outputs. This delay can be increased in increments of 1/150 seconds (6.667 ms), to minimize offsets between the LI-7500RS and other sensors.

For example, suppose you are sampling (via SDM output) the LI-7500RS with a Campbell Scientific CR5000 datalogger at 10 Hz (0.1 s). Setting the delay count of the LI-7500RS to 25 yields a total delay of 0.297 seconds, which means the LI-7500RS data will have a delay of 3 execution intervals (0.297 s/0.1 s), which the logger can allow for in synchronizing the data to the sonic anemometer or other analog measurements made by the datalogger. Thus, the “unaccounted for” lag is 0.003s. Without this extra delay, the lag time would be 0.130 seconds, which is 1 execution interval (0.1 seconds) plus 0.03 seconds unaccounted for.

Similarly, if you are sampling the LI-7500RS with the DAC outputs, setting the delay count to 19 yields a total delay of 0.299 seconds. The lag will be 0.001s.

Total System Delay Examples

Total System Delay (ms) = Delay Time + (Delay Step × Delay Step Increment)

Output	Delay Time (ms)	Delay Step (ms)	Delay Step Increment	Total Delay (ms)
DAC	172	6.667	19	299
SDM/RS-232/Ethernet	130	6.667	25	297

Bandwidth

Bandwidth (5, 10 or 20 Hz) determines the signal averaging done by the digital filter. To avoid aliasing (only a concern for co-spectra, not for fluxes), **one should sample the LI-7500RS at a frequency greater than or equal to 2 times the bandwidth.** Thus, if you are sampling at 10 Hz, the bandwidth is 5 Hz.

Bandwidth is the frequency at which the indicated amplitude is 0.707 of the real amplitude (*Figure 7-1* below).

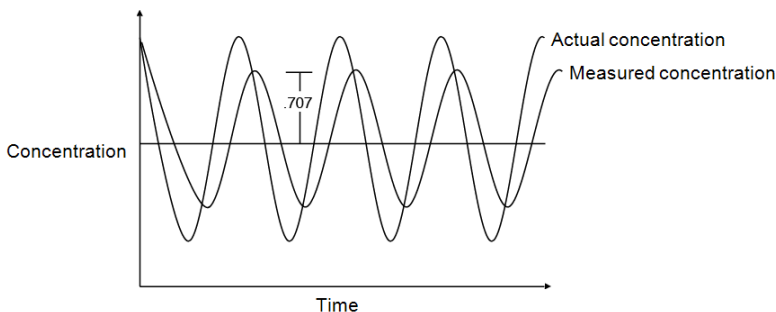

Figure 7-1. Bandwidth = 1/oscillation period.

Bandwidth is a useful indicator for characterizing real-world behavior in which there are fluctuating gas concentrations. Given a sinusoidal oscillation of concentration, the instrument's ability to measure the full oscillation amplitude diminishes as the oscillation frequency increases.

Diagnostic Value

The cell diagnostic value is a 1 byte unsigned integer (value between 0 and 255) with the following bit map:

bit 7	bit 6	bit 5	bit 4	bit 3	bit 2	bit 1	bit 0
Chopper	Detector	PLL	Sync	<-----Signal Strength / 6.67----->			
1=ok	1=ok	1=ok	1=ok				

Example: a value of 125 (01111101) indicates Chopper not ok, and Signal Strength = 87% (1101 binary converted to decimal is 13, times 6.67)

Bit	Name	Description
0 to 3	Signal Strength	Value \times 6.67 = Signal Strength.
4	Sync	Always set to 1 (OK)
5	PLL	Lock bit, indicates that optical wheel is rotating at the correct rate.
6	Detector	1 = Detector temperature is near setpoint 0 = Detector temperature is not near setpoint
7	Chopper	1 = Chopper wheel temperature is near setpoint 0 = Chopper wheel temperature is not near setpoint

Calibration Overview

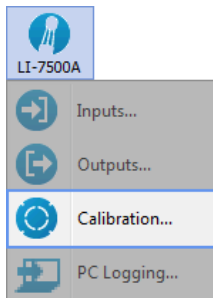

The LI-7500RS uses a fifth order polynomial for the CO₂ calibration, and a third order polynomial for the H₂O calibration. Step-by-step instructions for calibrating the LI-7500RS can be found in *Calibration* on page 4-1.

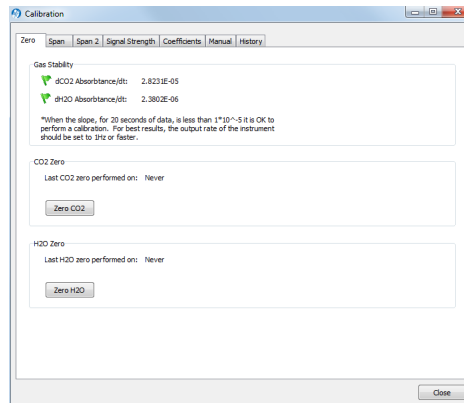

The **Calibration** window is where you set the zero and spans of the LI-7500RS. There are entry fields to set the target values for the span gases used to set the span of the instrument; CO₂ span gas target values are in ppm, and H₂O span gas target values are entered in °C dewpoint. The **Zero** and **Span** tabs also provide information about the stability of the gas flowing through the optical path:

- A green flag indicates that it is OK to perform the calibration
- A red 'X' indicates that it is **not OK** to perform the calibration; wait until the red 'X' changes to a green flag before performing the calibration.

Signal Strength Tab

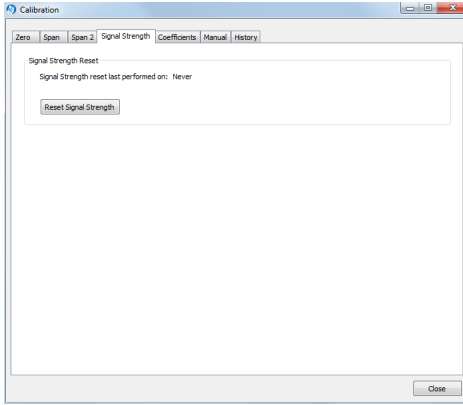

The **Signal Strength** tab has a button labeled **Reset Signal Strength** that you can click if you've decided your instrument optics are as clean as you can reasonably make them, and you want to reset the signal strength to 100.

See *CO2 Signal Strength* on page 8-7 for more information.

Coefficients Tab

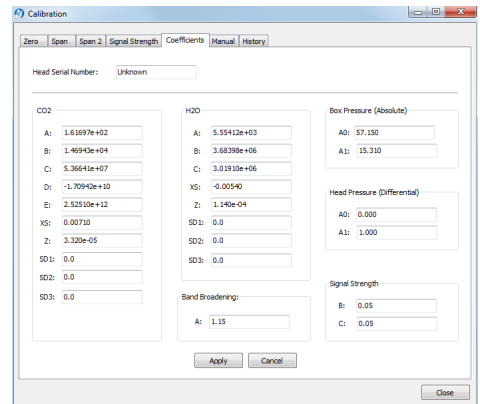

The **Coefficients** tab displays factory-determined calibration coefficients, a factor for correcting CO₂ measurements for band broadening due to the presence of water vapor (A), and a zero drift correction factor (Z). The coefficient shown as XS (Cross Sensitivity) compensates for slight cross sensitivity between CO₂ and H₂O signals absorbed by the detector (see *Cross Sensitivity* on page 8-3 and *Zero Drift* on page 8-3).

The calibration coefficients, XS, and Z values are unique to each sensor head, and may be found on the calibration sheet shipped from the factory. The Band Broadening coefficient is 1.15 for all sensor heads.

The calibration coefficients are stored in the LI-7550 Analyzer Interface Unit, not the sensor head. To change these values, edit them and then click Apply to send these values to the LI-7200 for implementation.

Caution: To avoid undesirable changes to the instrument performance, do not edit values in this window. Click **Cancel** to avoid any undesirable changes.

The *Head Serial Number* displays the serial number of the sensor head that is associated with the coefficients.

When exchanging sensor heads, it is necessary to change calibration coefficients, and to redo the zero and span.

Note: The easiest way to get the calibration coefficients, zero, and span updated for a sensor head is to save the configuration (it is a *.7x file) and then upload the file to a different LI-7550 using **Open Configuration**.

Manual Tab

The **Manual** tab displays current values for CO₂ and H₂O zero and span; after performing a zero and span calibration, these values should be near 1 (zero is typically between 0.9 and 1.1, and span is typically between 0.95 and 1.05; Z_{w_0} and Z_{c_0} , see equations 8-13 and 8-17). Span 2 values will be near zero.

We recommend that you track the zero values over time as you re-zero the instrument. As the internal chemicals lose their effectiveness, this value will increase. The CO₂ zero drift is also somewhat temperature dependent.

In most cases you will never need to manually edit these values. If, for some reason, the instrument calibration becomes unstable (e.g., you accidentally zeroed or spanned the instrument with the wrong gas), you can manually enter a value of 1

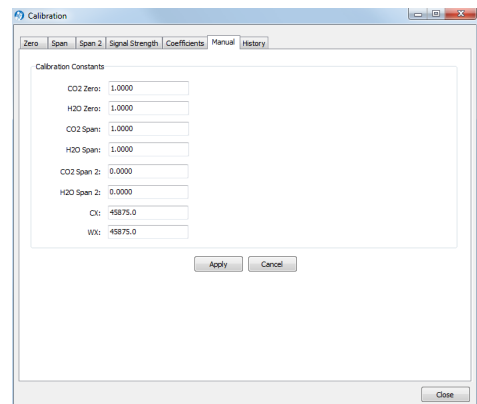

for each of these parameters (and zero for Span 2 values), and click **Apply**. This will return the instrument to a more normal state, after which you can perform zero and span calibrations again. Alternatively, if you have performed at least one previous (successful) calibration, you can restore those values using the **History** tab.

History Tab

The **History** tab displays a list of previous calibration backup files generated during a zero and/or span calibration of the instrument (when used with the same computer used to connect to the instrument). You can click on any previous calibration in the list to view the details; you can also restore the values from a previous calibration by choosing a file in the list and clicking the Restore button. Click **Delete** to permanently remove calibration files from the list stored on the computer.

Changing Sensor Heads

Sensor heads are freely interchangeable between LI-7550 Analyzer Interface Units. However, the LI-7550 must have the correct calibration coefficients and current zero and span information for the attached sensor head. This can be done by hand, or "automatically".

By Hand

1. Attach the new sensor head to the LI-7550
2. Connect the instrument to a computer and establish communications.
3. Enter the calibration coefficients from the Calibration Certificate under the Coefficients tab.
4. Zero and span the instrument.

Automatic

Acquire a calibration file for your instrument. You can get it from the LI-COR support site (www.licor.com/env/support) under calibration information, or you can save it from the LI-7550 (**Config Files > Save Configuration**). The file has a *.7x extension. To move a sensor head to another LI-7550:

1. Attach the new sensor head to the LI-7550.
2. Connect the instrument to a computer and establish communications.
3. Select **Config Files > Open Configuration**. Choose the file saved earlier; the coefficients will automatically be loaded.

4. Manually enter the Box Pressure calibration coefficients from the Calibration Certificate that came with the sensor head under the Coefficients tab.

The Box Pressure coefficients saved in the old configuration file should not be used with the new Analyzer Interface Unit.

Diagnostic Messages



The **Diagnostics** page allows you to view the current operational state of the instrument, including current software versions, diagnostic flags, optical bench properties, and technician test point values.

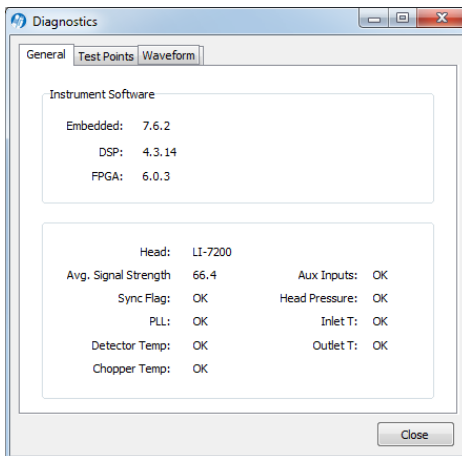

General indicators

Diagnostic indicators for the Sync Flag, PLL, Detector Temperature, and Chopper Temperature will read either **OK** or **Service**.

Head – Displays the model of the sensor head currently connected to the LI-7550 Analyzer Interface Unit. The software may display LI-7200 even if an LI-7200RS is connected and LI-7500A even though an LI-7500RS is connected.

Avg. Signal Strength – Average Signal Strength is a coarse indicator of when to clean the instrument, where 100 is clean, 80 is relatively dirty, 50 is very dirty, and 0 would mean no signal at all.

Sync Flag – Not used. Will always read **OK**.

PLL - Phase Lock Loop offset, indicates the status of the optical filter wheel for the IRGA. Common causes of a service indication are not having a sensor head connected to the LI-7550, the head cable is not been tightened properly, or the cable has failed.

Detector Temperature - If not OK, indicates the detector cooler is not maintaining the proper temperature: this will happen at temperatures above 50 °C. This does not always indicate a serious problem; the cooler may simply have not yet reached the target temperature during instrument startup, or it may be out of range due to external environmental conditions. Readings may still be OK. The sensor head may not be attached to the LI-7550, or the IRGA cable may not be tight. Check cables and wiring.

Chopper Temperature - If not OK, indicates the chopper temperature controller is out of range, hot or cold. As with the Detector Temperature indicator above, this may or may not indicate a serious problem. The chopper should be able to temperature control when ambient is between +50 and -25 °C. Check that the sensor head cables to the LI-7550 are tight, and make sure the chopper temperature is not set to Winter when measuring in high ambient temperatures.

Aux Inputs – If not OK, indicates that the two reference voltages on the LI-7550 analog circuit board cannot be checked properly. The LI-7550 needs service.

Head Pressure – If not OK, the pressure reading at the LI-7500RS sensor head is outside of its normal range. A service indication can also be caused by a loose or missing cable between the LI-7550 and the LI-7500RS sensor head.

Test Point Values

The **Test Points** ab displays voltages and raw counts of a variety of diagnostic test points. Though primarily for LI-COR technician reference, values outside of the normal range may give you an indication of where problems may be originating.

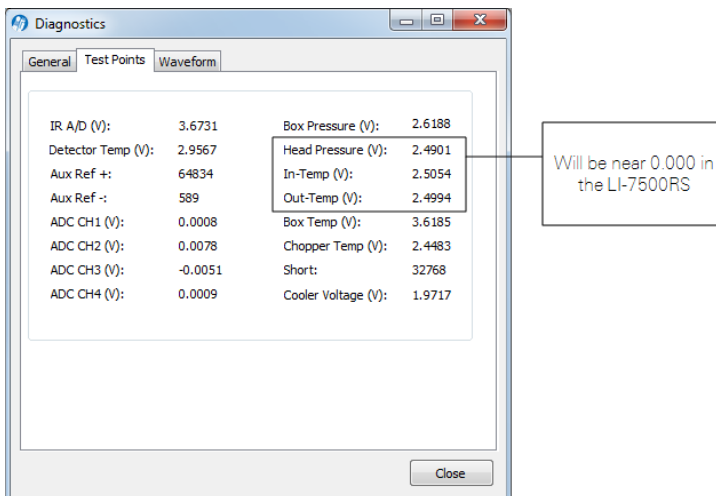

Test Point	Description	Normal range
IR A/D (V)	Voltage from IRGA being sent to A/D converter	0.2 – 4.8 V
Detector Temp (V)	Detector temperature voltage	2.9 V. Readings near +5 V or 0 V are normal for a few seconds after power on.
Aux Ref +	16-bit conversion of positive reference voltage used in Auxiliary Input circuit	~64830
Aux Ref -	16-bit conversion of negative reference voltage used in Auxiliary Input circuit	~600
ADC CH1 (V)	Analog input channel 1	-5 V to +5 V. A reading near 0 is normal for an open input.
ADC CH2 (V)	Analog input channel 2	-5 V to +5 V. A reading near 0 is normal for an open input.

Test Point	Description	Normal range
ADC CH3 (V)	Analog input channel 3	-5 V to +5 V. A reading near 0 is normal for an open input.
ADC CH4 (V)	Analog input channel 4	-5 V to +5 V. A reading near 0 is normal for an open input.
Box Pressure (V)	Absolute pressure	Any value between 0 and 5
Box Temp (V)	LI-7550 temperature	3.5 at room temperature
Chopper Temp (V)	Displays voltage of chopper housing temperature control circuit.	2 is normal. Readings near 0 V or +5 V indicate that the temperature control circuit is unable to control the chopper temperature.
Short (V)	Reference short in auxiliary input circuit	32768
Cooler Voltage (V)	Displays voltage of detector cooler. If this value gets below 0.5V, it may be too cold; the detector may not be temperature controlling. This will typically occur at -30 °C or below.	0 V to +5 V

Waveform

The **Waveform** tab displays the current state of the analyzer's chopping shutter disk. Though primarily for LI-COR technician reference, if problems are encountered, it may be useful to log the waveform data for troubleshooting purposes. Waveform data can only be logged when the **Diagnostics** window is open.

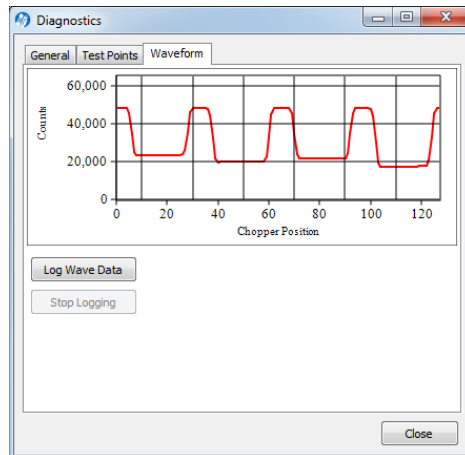

Charting

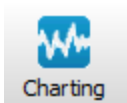

The **Strip Chart** page allows real time graphics display of one or two variables plotted against time. The Y-Axes (left and right) display the value chosen in the respective menus against time on the X-Axis.

Time on the X-Axis can be displayed over user-defined values of seconds or minutes; the X-Axis Max value defines the unit of time displayed in the window before the window starts scrolling the time value off the right edge.

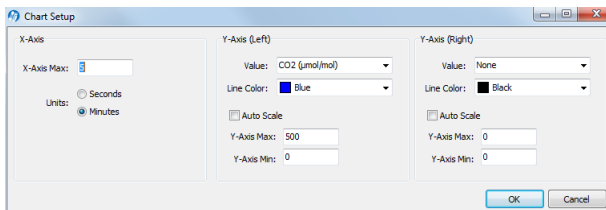

Choose the value for the Y-Axis Left and/or Y-Axis Right in the menu(s), and enter values for the Y-Axis maximum and minimum; choose Auto Scale if you want the chart to scale the Y-Axis automatically to keep data from scrolling off the top or bottom edges. You can also select the color of the line for both Y-Axes values.

When you are finished defining the strip chart(s) parameters, click **OK**. A new chart window will appear. Press **Pause All** to temporarily stop plotting (press **Pause All** again to resume); press **Save** to save a “snapshot” of the current plot to a bitmap file; press **Print** to print the currently displayed chart window, or press **Options** to open the Chart Setup window again to make changes to the strip chart parameters.

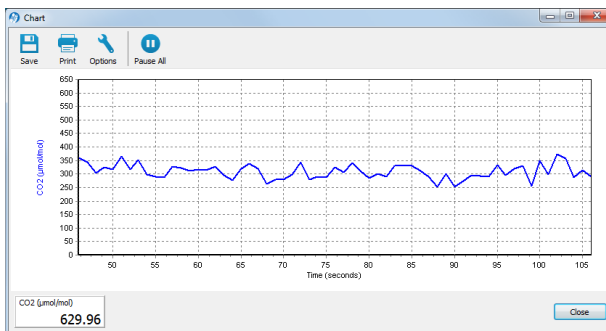

Note: You can rescale both Y-axes of an active strip chart by right clicking on the chart, holding, and dragging up or down. You can also open as many chart windows as you want.

PC Logging

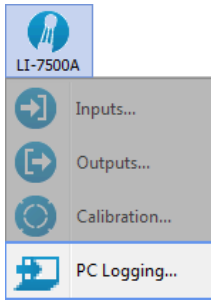

The PC Logging window is used to configure the data output parameters used while the LI-7500RS Windows software is active. Data are logged to a file on your computer. You can specify the destination file, update rate, file duration, comments, and values to be logged.

Note: File compression and metadata information are not available when logging to a PC; these options are available only when logging to the USB drive (see *Configuring Eddy Covariance Measurements* on page 3-13).

Data can be logged at up to 20 Hz. These files can be split into smaller files, at 15, 30, 60 minutes, or 1.5, 2, 4, or 24 hour intervals. The files are split based fractions of the hour as measured by the system clock. Thus, if you choose to split the files at 15 minute intervals and start logging at 10:22, the file will be split at 10:30, 10:45, 11:00, etc.

Under **Log Values**, select the data records that you want to output; click **Select All** to choose all variables. The data items available to log are given in on page 3-5.

Press **Start** to begin logging data and **Stop** to quit logging.

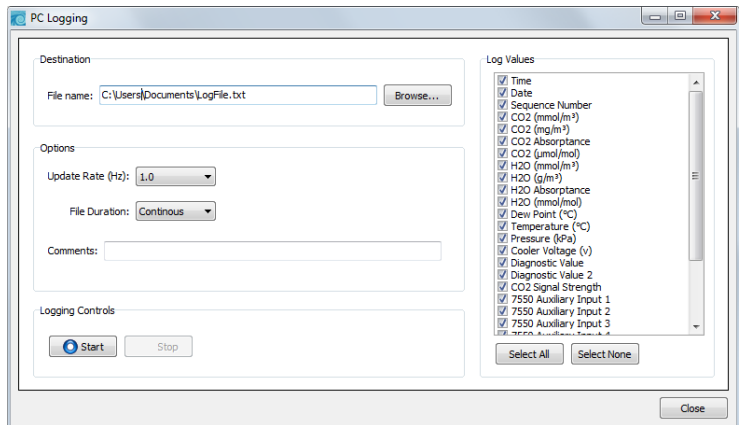

Configuration Files

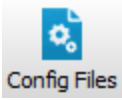

The PC software uses a configuration file to store parameters of the instrument configuration. These configuration files include information such as auxiliary input calibration coefficients, DAC output channels, instrument calibration coefficients and zero and span values, and the source channels that you want to log. Unique configuration files can be set up, saved, and then re-opened to easily change your setup information.

When the software program is started for the first time, a default set of parameters is loaded, which can be modified and saved as a new configuration file with a different name. The analyzer stores its configuration so that it will power on configured just as it was when it was powered off.

To open an existing file, click on the **Config Files** button and select **Open Configuration**. Locate the file on your computer, and click **Open**. The configuration file parameters are automatically applied to the current software session. You are prompted to send the configuration to the instrument; changes are not implemented in the instrument until the configuration file is applied.

To save a configuration file, click on the **Config Files** button and select **Save Configuration**. Select the items in the **Save Options** dialog that you want to store in the configuration file, and click **Continue**.

Choose the location to which you want to save the file, enter a file name, and click **Save**. File names are automatically appended with a **.I7x** file extension to denote an LI-7200RS or LI-7500RS configuration file.

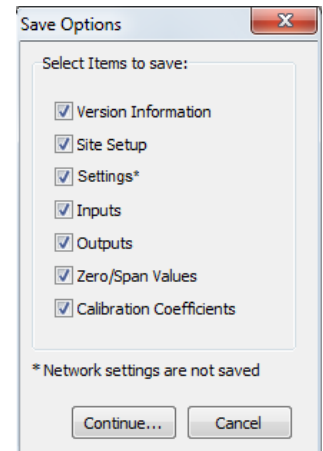

Software Updates

We recommend running the most current software at all times, including both the embedded instrument software for the LI-7500RS/LI-7200RS and the PC applic-

ation. You can acquire the software from the LI-COR® web site: www.licor.com/env/support

On the support web site, select your instrument, then select "Software." Download both the **Instrument (Embedded) Software** and the **Windows Interface Software**.

Embedded Instrument Software

To update the embedded instrument software:

1. Connect your instrument to the gas analyzer using an Ethernet cable, as shown. Power on the gas analyzer.

Important: *There must be a USB drive in the LI-7550 USB port.*

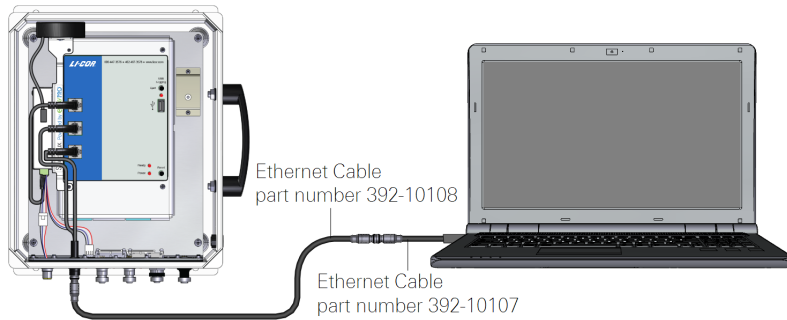

The Instrument (Embedded) Software is a zipped file named something similar to **LI-7xxx_embedded-7.0**. Unzip the files and save them.

2. Double-click the file called **update7x00**.
3. Click **Browse...** and select the instrument from the list. You may need to allow the application to pass through your computer's firewall.
4. Select the gas analyzer from the list and click **Update Software**.

The update will take about 5 minutes.

Important: *Do not close the software, let your PC go to sleep, or power off the instrument during the update process. The software will notify you when the update is complete. If the update fails for any reason, repeat steps 2 and 3.*

If you are updating from embedded version 4.x.x or earlier, you must also run the FPGA update. To check if this update is necessary click the **Check FPGA** button.

Note: Do not check the FPGA version until you update the system software.

If the FPGA update is needed the **Update FPGA** button will become enabled in the application. The update takes approximately 8 minutes.

Important: *Do not close the software or reset the instrument while the update is taking place. The software will notify you once the FPGA programming is finished.*

5. After updating the software, check all your instrument configuration settings. The instrument should retain all settings through a software update, but in unusual circumstances, some settings may be lost.

Troubleshooting: Getting an update error? There must be a USB drive installed in the LI-7550 USB port before you can update. Also, if the drive is inserted for the first time, the instrument will take a few minutes to connect with the drive.

PC Software Update

To update the PC Desktop Software:

1. The PC Desktop Software is an executable file named something similar to LI-7xxx_win-7.0. Double click to launch the installer.
2. Follow the Windows Installation wizard to install the application.

Section 8. Theory of Operation

Relating Absorption to Concentration

The scaling law of Jaimeson et. al., (1963) shows the effect of pressure on infrared absorption. If the amount of absorber of some gas u_i (mol m⁻²) and absorption in a band are related by some function $h_i()$, then

$$\frac{\alpha_i}{P_{ei}} = h_i\left(\frac{u_i}{P_{ei}}\right) \quad 8-1$$

The subscript i denotes a particular (i^{th}) gas. Pressure is denoted as P_{ei} because it is the equivalent pressure for the i^{th} gas. Equivalent pressure is potentially different from total pressure P if there are gases present other than i that affect how the i^{th} gas absorbs radiation.

We rewrite this in terms of number density (mol m⁻³) by introducing a path length λ , and noting that $u_i = \rho_i \lambda$. Substituting this into equation 8-1, and solving for the number density ρ_i of gas i yield

$$\rho_i = \frac{P_{ei}}{\lambda} h_i^{-1}\left(\frac{\alpha_i}{P_{ei}}\right) \quad 8-2$$

We rewrite equation 8-2 as

$$\rho_i = P_{ei} f_i\left(\frac{\alpha_i}{P_{ei}}\right) \quad 8-3$$

by combining λ and the inverse $h()$ functions into a new function $f_i()$. The calibration function $f_i()$ is generated by measuring a range of known densities ρ_i and fitting a curve to ρ_i/P_{ei} plotted against α_i/P_{ei} . Since gas standards are not available in “known densities”, the ρ_i values are computed from known concentrations m_i (moles of gas per mole of air) using the ideal gas law

$$\rho_i = m_i \frac{P}{RT} \quad 8-4$$

Measuring Absorptance

Given a source with radiant power Φ , and a detector some distance away, in the absence of reflection, absorptance by gas i can be determined from

$$\alpha_i = 1 - \tau_i = 1 - \frac{\Phi_i}{\Phi_o} \quad 8-5$$

where τ_i is transmittance through gas i , Φ_i is transmitted radiant power in the absorption band with some concentration of gas i present, and Φ_o is the transmitted radiant power in the absorption band with zero concentration of i present. The LI-7500RS approximates absorptance by

$$\alpha_i = \left(1 - \frac{A_i}{A_{io}} \right) \quad 8-6$$

where A_i is the power received from the source in an absorbing wavelength for gas i , and A_{io} is the power received from the source in a reference wavelength that does not absorb gas i . The LI-7500RS measures A_i and A_{io} alternately 150 times per second.

If we combine equations 8-6 and 8-3, we can write the full equation for computing molar density from absorptance.

$$\rho_i = P_{ei} f_i \left(\left[1 - \frac{A_i}{A_{io}} z_i \right] \frac{S_i}{P_{ei}} \right) \quad 8-7$$

Note the zeroing term z_i and the span adjustment term S_i in equation 8-7. The span adjustment term is a linear function of absorptance (see *What Actually Happens* on page 4-9):

$$S_i = S_{i0} + S_{i1} \alpha_i \quad 8-8$$

Cross Sensitivity

Because the LI-7500RS uses one detector for measuring A_c , A_{co} , A_w , and A_{wo} , (the absorbed and non-absorbed power for CO₂ and H₂O, respectively), there is a slight cross-sensitivity between gases due to imperfections in the detector's frequency (time) response. This varies from detector to detector, but is measured during calibration, and is corrected in software. Equation 8-6 is written as

$$\alpha_i = \left(1 - \left[\frac{A_i}{A_{io}} + X_{ji} \left(1 - \frac{A_j}{A_{jo}} \right) \right] \right) \quad 8-9$$

where X_{ji} is the cross sensitivity response of gas j on gas i (determined during calibration), and A_j and A_{jo} are the absorbed and non-absorbed power for gas j . Equation 8-7 becomes

$$\rho_i = P_{ei} f_i \left(\left[1 - \left(\frac{A_i}{A_{io}} + X_{ij} \left[1 - \frac{A_j}{A_{jo}} \right] \right) \right] z_i \left[\frac{S_i}{P_{ei}} \right] \right) \quad 8-10$$

Zero Drift

Even though the detector and filters are temperature controlled in the LI-7500RS, the detector is subject to slight temperature drift as ambient temperature changes. This error is directly related to the detector cooler control voltage, which is measured, and thus provides a mechanism for a software "fine tuning".

The zero term z_i is computed from

$$z_i = Z_{io} + Z_i V_d \quad 8-11$$

where V_d is the cooler voltage, Z_i is the slope of the relationship between V_d and z_i (determined during calibration), and Z_{io} is the zero factor determined when setting the zero.

Equation Summary

H₂O

In the atmosphere, the absorption of radiation by water vapor is not significantly influenced by any other gas, so the effective pressure for water vapor P_{ew} is simply the total pressure P .

$$P_{ew} = P \quad 8-12$$

H₂O absorptance α_w is (from 8-10 and 8-11).

$$\alpha_w = \left(1 - \left[\frac{A_w}{A_{wo}} + X_{cw} \left[1 - \frac{A_c}{A_{co}} \right] \right] \right) (Z_{wo} + Z_w V_d) \quad 8-13$$

where X_{cw} is the cross sensitivity factor for CO₂ on water vapor ("H₂O XS" on the calibration sheet), Z_w is the zero drift coefficient ("H₂O Z" on the calibration sheet).

H₂O number density ρ_w is given by

$$\rho_w = P f_w \left(\frac{\alpha_w S_w}{P} \right) \quad 8-14$$

The coefficients for the 3rd order polynomial $f_w(\cdot)$ are given on the calibration sheet. The polynomial has the form $AX + BX^2 + CX^3$, where $X = \left(\frac{\alpha_w S_w}{P} \right)$.

CO₂

The absorption of radiation by CO₂ molecules is influenced by several other gases, including O₂ and H₂O. Since the concentration of H₂O is most variable, it must be accounted for in the equivalent pressure of P_e . A method of doing this (LI-COR Application Note #116) is

$$P_{EC} = P \psi(W_f) \quad 8-15$$

where

$$\psi(W_f) = 1 + (\alpha_w - 1)W_f \quad 8-16$$

and W_f is the mole fraction of water vapor (mol/mol). a_w has been determined to be 1.15 for the LI-7500RS.

CO₂ absorptance α_c is given by

$$\alpha_c = \left(1 - \left[\frac{A_c}{A_{co}} + X_{wc} \left[1 - \frac{A_w}{A_{wo}} \right] \right] \right) (Z_{co} + Z_c V_d) \quad 8-17$$

where X_{wc} is the cross sensitivity factor for H₂O on CO₂ ("CO₂ XS" on the calibration sheet), Z_c is the zero drift coefficient ("CO₂ Z" on the calibration sheet).

CO₂ molar density ρ_c (mmol m⁻³) is

$$\rho_c = P_{ec} f_c \left(\frac{\alpha_c S_c}{P_{ec}} \right) \quad 8-18$$

The coefficients for the 5th order polynomial $f_c()$ are given on the calibration sheet. The polynomial has the form $AX + BX^2 + CX^3 + DX^4 + EX^5$, where $X = \left(\frac{\alpha_c S_c}{P_{ec}} \right)$.

LI-7500RS Implementation

Atmospheric pressure P_g (kPa) and temperature T_g ($^{\circ}\text{C}$) are measured by sensors in the Analyzer Interface Unit.

Table 8-1. Fundamental equations used in the LI-7500RS calculations.

Label	Description	Equation	
H_2O mmol/ m^3	H_2O number density	$\rho_w = P_g f_w \left(\frac{\alpha_w S_s}{P_g} \right)$	8-19
H_2O g/ m^3	H_2O mass density	$W_m = \frac{18}{1000} \rho_w$	8-20
H_2O mmol/mol	H_2O mole fraction	$W_f = \frac{\rho_w R (T_g + 273.15)}{1000 P_g}$	8-21
Dew Point ($^{\circ}\text{C}$)	Dew point temperature	$T_d = \frac{240.97x}{17.502 - x}$	8-22
		$x = \ln \left(\frac{W_f}{613.65} P_g \right)$	8-23
CO_2 mmol/ m^3	CO_2 number density	$\rho_c = P_g \psi \left(\frac{W_f}{1000} \right) f_c \left(\frac{\alpha_c S_c}{P_c \psi \left(\frac{W_f}{1000} \right)} \right)$	8-24
CO_2 mg/ m^3	CO_2 mass density	$C_m = 44 \rho_c$	8-25
CO_2 $\mu\text{mol}/\text{mol}$	CO_2 mole fraction	$C_f = \frac{\rho_c R (T_g + 273.15)}{P_g}$	8-26

A Note About Pressure And Temperature

Since the LI-7500RS is calibrated for number density, accurate temperature is not required for the calculation, and accurate pressure measurement is not required, either (equations 8-19 and 8-24). For example, if you introduce a 1% error in the pressure sensor on a perfectly calibrated instrument, the resulting CO₂ mole density error would be about 0.25%, and the H₂O mole density error about 0.5% in typical ambient conditions.

When calibrating (specifically when setting spans), temperature and pressure are more important. Calibrating with a 1% pressure error will cause the resulting CO₂ mole density to have a 1% error, but no error in the resulting H₂O mole density (because the water span target is computed from dew point, not mole fraction). A 1% error in temperature (3 °C) will cause a 1% error in both CO₂ and H₂O mole density.

LI-7500RS Diagnostics

CO₂ Signal Strength

The raw reference signal A_{co} (for CO₂) can be used for diagnostic purposes. A_{co} is insensitive to CO₂ and H₂O concentrations, so if it is reduced, it could be due to obstructions (dirt, precipitation, etc.) in the optical path. The value of this signal by itself is not very informative: all you are guaranteed of is that it will be somewhere between 0 and 65535, but more typically between 25000 to 50000. To get a useful diagnostic out of A_{co} , one needs to know the expected value for a particular instrument when everything is clean and normal. If A_{cx} is the maximum expected value for A_{co} , then we could calculate a signal strength S_c for CO₂ from

$$S_c = \frac{A_{co}}{A_{cx}} \times 100 \quad 8-27$$

S_c is on a 0 to 100 scale, where 100 is clean. This value is not 'clipped' at 0 or 100, so may slightly exceed 100, especially after signal strength is reset. This simply reflects slight differences from reality of the temperature compensation function $f(T)$, as shown below in 8-29.

The problem with an implementation this simple is that the raw signals are a function of not only the optical throughput (obstructions, source and detector aging, etc.), but also temperature. Unless one accounts for that, the S_c could actually respond to diurnal temperature changes as much or more than contamination changes. Thus, the proper A_{cx} needs to be a function of temperature. Fortunately, we characterize this response at the factory as part of the factory calibration of each individual unit, which allows us to use the following formulation for signal strength for CO₂:

$$S_c = \frac{A_{co}}{C_x \times f(T)} \times 100 \tag{8-28}$$

where C_x is the maximum value of A_{co} that we would expect from this unit. The function $f(T)$ characterizes how the raw reference signal varies with cooler voltage V :

$$f(V) = \frac{0.2}{1 + b \times e^{c(V-2.5)}} + 0.8 \tag{8-29}$$

Average values of b and c are 1.6 and 3.2, but the values for a particular unit are found on its calibration sheet. *Figure 8-1* below illustrates this function by showing the range of responses for a large population of LI-7500RSs.

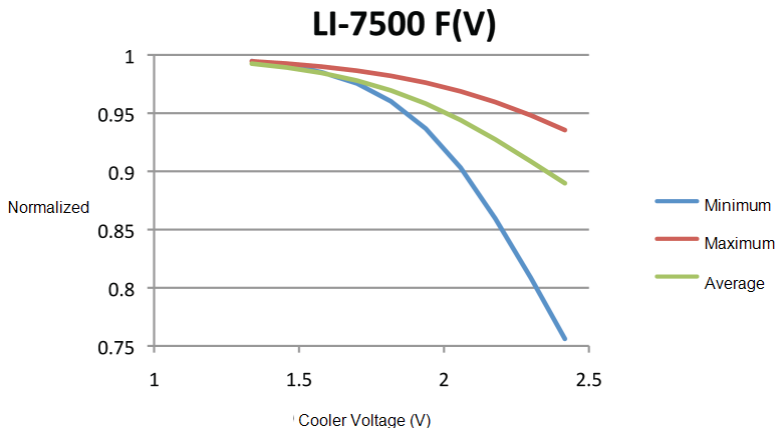

Figure 8-1. The function $f(T)$ characterizes how the raw reference signal varies with temperature.

The C_x value is determined at the factory, but it is not really a “factory parameter”; it will likely change over time, due to source or detector aging, or even some thin-film contaminant that gets on a window that you just can’t clean off. Thus, the LI-7500RS has a provision for you to easily reset C_x to a value that reflects the reality of your instrument at any point in time. The Calibration button of the Windows Interface program (see *Calibration* on page 4-1) opens a window with a Signal Strength tab. There you will find a button labeled “Reset Signal Strength” that you can push if you’ve decided your instrument is as clean as you can reasonably make it, and you want to reset the signal strength to 100. It does this by using the current value of A_{co} and performing the following computation:

$$C_x = \frac{A_{co}}{f(V)} \quad 8-30$$

A signal strength-based value is available from the LI-7500RS when using the PC software. The instrument’s grammar also makes S_c available for output.

Appendix A. Specifications

CO₂ Measurements

Calibration Range: 0 to 3000 $\mu\text{mol mol}^{-1}$

Accuracy: Within 1% of reading

Zero Drift (per °C):

±0.1 ppm typical; ±0.3 ppm maximum

RMS Noise (typical @ 370 ppm CO₂):

@5 Hz: 0.08 ppm

@10 Hz: 0.11 ppm

@20 Hz: 0.16 ppm

Gain Drift (% of reading per °C @ 370 ppm):

±0.02% typical; ±0.1% maximum

Direct Sensitivity to H₂O (mol CO₂ mol⁻¹ H₂O):

±2.00E-05 typical; ±4.00E-05 maximum

H₂O Measurements

Calibration Range: 0 to 60 mmol mol⁻¹

Accuracy: Within 1.5% of reading

Zero Drift (per °C):

±0.03 mmol mol⁻¹ typical; ±0.05 mmol mol⁻¹ maximum

RMS Noise (typical @ 10 mmol mol⁻¹ H₂O):

@5 Hz: 0.0034 mmol mol⁻¹

@10 Hz: 0.0047 mmol mol⁻¹

@20 Hz: 0.0067 mmol mol⁻¹

Gain Drift (% of reading per °C @ 20 mmol mol⁻¹):

±0.15% typical; ±0.30% maximum

Direct Sensitivity to CO₂ (mol H₂O mol⁻¹ CO₂):

±0.02 typical; ±0.05 maximum

General

Fundamental Gas Sampling Rate: 150 Hz

Bandwidth: 5, 10, or 20 Hz; software selectable

Type: Absolute, open-path, non-dispersive infrared gas analyzer

Detector: Thermoelectrically cooled lead selenide

Path Length: 12.5 cm (4.92")

Air Temperature Thermistor: 10K ohm @ 25 °C thermistor; Accurate to ± 0.5 °C

Pressure Sensor:

Range: 65 to 115 kPa absolute

Accuracy: $\pm 0.1\%$ of full scale

Resolution: 0.002 kPa

Signal Noise (peak-to-peak): 0.002 kPa typical

Inputs: Ethernet, 4 analog input channels (± 5 V, 16 bit)

Outputs: RS-232 (20 Hz Maximum); SDM (User selectable to 50 Hz); Ethernet; 6 user-scalable 16 bit DACs (0-5 V range, single-ended)

Operating Temperature Range: -25 to 50 °C (-40 to 50 °C verification on request)

Relative Humidity Range: 0-95% (non-condensing)

Data Storage: Removable industrial grade USB flash storage

Data Communication: Ethernet, Synchronous Device for Measurement (SDM; User-selectable to 50 Hz), RS-232 (115200 baud); 20 Samples/Sec. max., 6 DACs (single ended; 0-5 V)

Weatherproof Rating: Tested to IEC IP65 standard

User Interface: Windows® PC software

Power Requirements: 10.5 to 30 VDC

Power Consumption: 30 W during warm-up, 10 W in steady state

Dimensions:

Head: Diameter 6.5 cm, Length 30 cm.

LI-7550 Analyzer Interface Unit: 35 cm \times 30 cm \times 15 cm

Head Cable: 5 meters. Can be extended to 10 meters

Other cables: 5 meters

Weight:

Head: 0.75 kg (1.65 lb.)

LI-7550 and Cables: 4.8 kg (10.5 lb.)

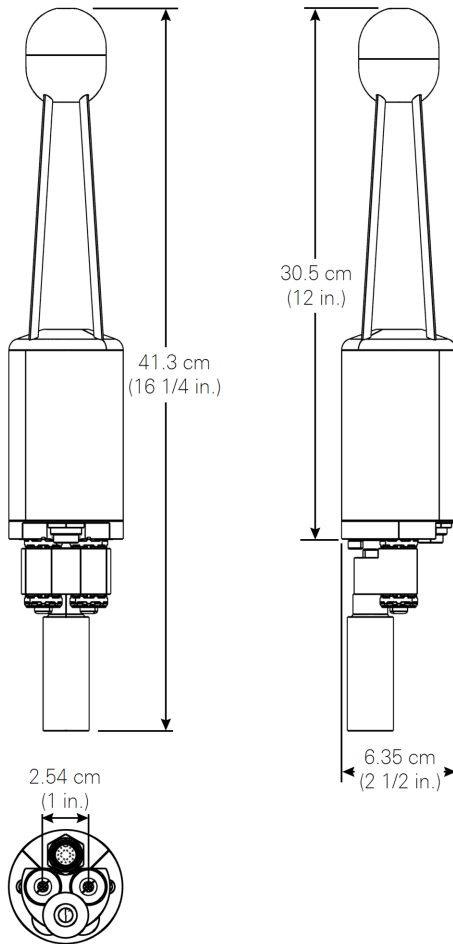

Gas Analyzer Dimensions

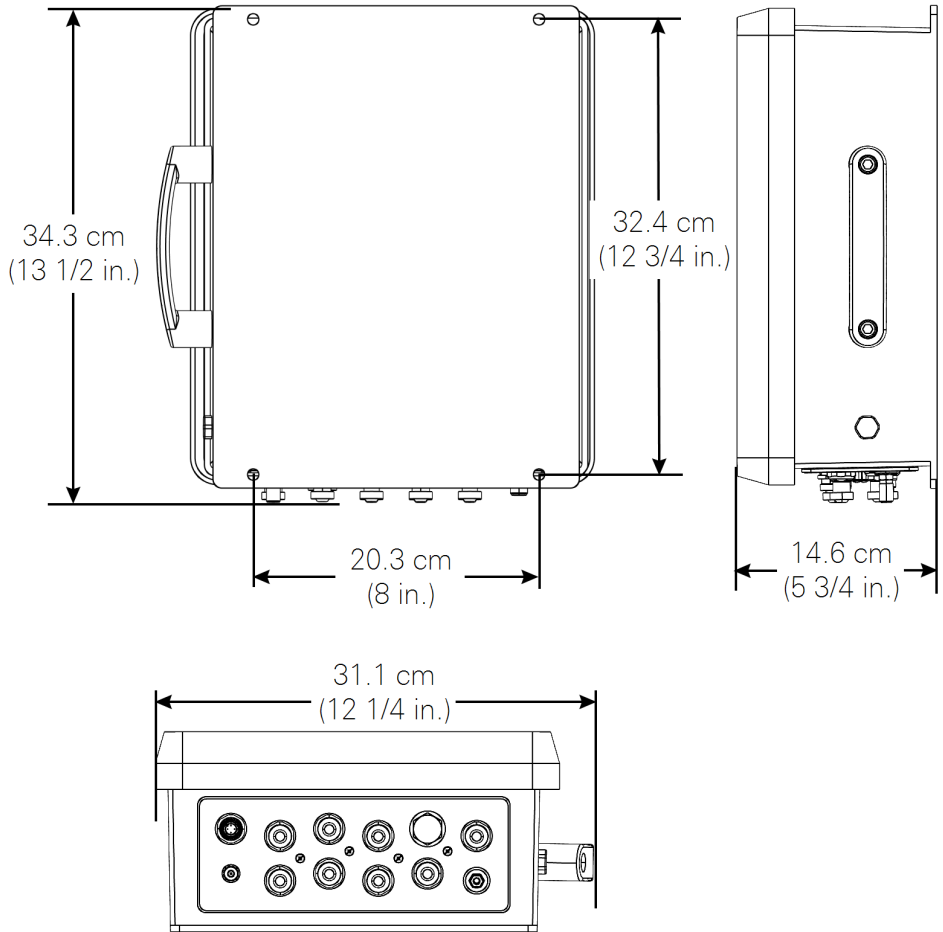

LI-7550 Dimensions



Appendix B. Pin Assignments

LI-7550 Pin Assignments								
SDM			AUXILIARY INPUT			DAC OUTPUT		
PIN 1	BROWN	SDM_EN	PIN 1	WHITE	AUX1+	PIN 1	WHITE	DAC1
PIN 2	WHITE	SDM_CLK	PIN 2	BROWN	AUX1-	PIN 2	BROWN	DAC2
PIN 3	BLUE	SDM_DATA	PIN 3	GREEN	AUX2+	PIN 3	GREEN	DAC3
PIN 4	BLACK	GND	PIN 4	YELLOW	AUX2-	PIN 4	YELLOW	DAC4
COUPLING	BARE	EARTH GND	PIN 5	GREY	AUX3+	PIN 5	GREY	DAC5
POWER			PIN 6	PINK	AUX3-	PIN 6	PINK	DAC6
PIN 1	BROWN	VIN-	PIN 7	BLUE	AUX4+	PIN 7	BLUE	READY
PIN 2	WHITE		PIN 8	RED	AUX4-	PIN 8	RED	NC
PIN 3	BLUE	VIN+	PIN 9	ORANGE	+5V	PIN 9	ORANGE	NC
PIN 4	BLACK	VIN+	PIN 10	TAN	GND	PIN 10	TAN	GND
INPUT: 10.5 - 30VDC 			PIN 11	BLACK	GND	PIN 11	BLACK	GND
FUSE: 5A F 125/250V 			PIN 12	VIOLET	GND	PIN 12	VIOLET	GND

DB-9 Connector on RS-232 Cable

The serial cable (part number 392-10268) has a round connector that attaches to the LI-7550 and a female DB-9 connector attaches to a computer. Note that not all pins are used for communication between the LI-7550 and a computer.

DB-9 Pin Assignments

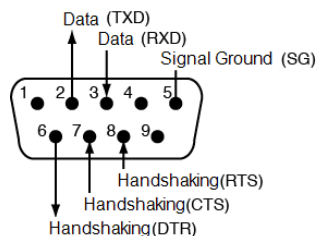

Appendix C. Suppliers

The company names, addresses, and phone numbers are the most current we have at the time of this printing. In some cases the information may change without notice.

Chemical Sources

Material	LI-COR Part Number
Ascarite II, 500 g	9970-022
Magnesium Perchlorate, 2 kg	9960-078

Fisher Scientific www.fishersci.com 800-766-7000 770-871-4500	VWR Scientific Products www.vwrsp.com 800-932-5000 908-757-4045
Thomas Scientific www.thomassci.com 800-345-2100 856-467-2000	GFS Chemicals, Inc. www.gfschemicals.com 800-394-5501 740-881-5501
P.W. Perkins Co., Inc. www.pwperkins.com 856-769-3525	LI-COR Biosciences 4421 Superior Street Lincoln, NE 68504 USA 800-447-3576 402-467-3576 www.licor.com

Internal Chemical Bottle Kit

The internal scrubbing bottles on the LI-7500RS gas analyzer can be purchased in a pre-charged kit that is ready to use. The bottles contain magnesium perchlorate and Ascarite II. The LI-7500RS kit can be ordered under part number 7200-950, and contains two small bottles.

Cables

Turck, Inc.
 3000 Campus Drive
 Minneapolis, MN 55441
 Phone: 612-553-7300
 FAX: 612-553-0708
 www.turck.com

Table C-1. Turck® cables used to connect to the LI-7500RS.

LI-COR Part Number	Cable	Cable Connector	Turck Part Number
392-10094	Power	4-pin female	RK4.41T-*/S529
392-10093	SDM Interface	4-pin male	RSS 4.4T-*
392-10268	Serial	6-pin female to DB-9 female	RKC 6T-* DB9F/CS12317
392-10109	Analog In/Out	12-pin male	RSS 12T-*
392-10108	Ethernet	8-pin male-male	RSS RSS841-*M
392-10107	Ethernet Adapter	8-pin female to RJ45	RKC RJ45 840-*M

* = cable length

OCP Group Inc
 7130 Engineer Rd
 San Diego, CA 92111
 Phone:858-279-7400
 www.ocp.com

LI-COR Part Number	Cable	Cable Connector	OCP Part Number
392-13984	19-pin head cable	19-pin male to female	Specify LI-COR 392-13984 and the length you prefer

Industrial Rated USB Flash Drives

16 GB industrial grade drives are available directly from LI-COR. Contact us for more information.

NOTE: The USB flash drive listed below has been tested by LI-COR; if you want to use other drives in the LI-7550, please contact LI-COR for more information.

APRO Co., Ltd.

www.apro-tw.com

16GB Drive:

LI-COR Part Number: 616-10723

APRO Part Number: WMUFD016G-ACCMC/3C

Appendix D. Configuration Grammar

Note: This grammar supports the core features of the instrument, but some functions are not fully described. Contact technical support at envsupport@licor.com if you have questions.

This section describes the protocol used by the instrument to communicate via RS-232 and Ethernet, for both configuration and data output purposes. Commands sent to the instrument have a certain structure that must be followed, and data sent by the instrument comes packaged in a particular way. For example, to set the Bandwidth to 10Hz, the following string

```
(Outputs (BW 10))
```

should be sent followed by a line feed character (decimal 10). Each command begins with a left parenthesis ‘(’, and ends with a right parenthesis ‘)’. Some commands, such as (BW...), contain a single value, while other commands, such as (Outputs...), can contain one or more commands. The parentheses mark the start and stop of the command, and extra characters before or after are ignored, as well as white space (spaces and tabs) before or after the parentheses. This string would work equally as well, for example:

```
This is ignored ( Outputs (BW 10) ) and so is this
```

The LI-7500RS does not try parsing a command string until a line feed is received. Since "extra" characters are ignored, commands can be terminated with carriage return and line feeds equally as well.

Another example of a command string is

```
(Outputs (RS232 (Freq 10) (Pres TRUE) ) (BW 5) )
```

In this case, we are setting the RS-232 output frequency to 10Hz, requesting that Pressure be included in the output records, and that the bandwidth be 5 Hz. Notice the 2 parentheses at the end of `(Pres TRUE)`. This is because `(Pres..)` and `(Freq..)` are `(RS232..)` commands, while `(BW..)` is not. `(BW..)` and `(RS232..)` are both `(Outputs..)` commands, however, and the “extra” parenthesis at the end of `(BW 5)` signals the end of the `(Outputs..)` command.

An illegal command string would be

```
(BW 5)
```

because the `(BW...)` command is only recognized within the context of an `(Outputs...)` command.

The configuration grammar is case sensitive. That is, `(Outputs(BW 10))` will work, while `(outputs(bw 10))` will not.

Who Sends What

Not all of the commands in the instrument grammar are really commands. Some are designed to be used by the instrument to package outgoing data. The `(Data..)` command, or record, might look like this

```
(Data (CO2D 2.2083146e1) (H2OD 3.5485935e2) (Temp 2.5886261e1) (Pres 9.8157062e1))
```

This record is showing the latest values of CO₂ and H₂O mole density (mmol m⁻³), temperature (°C), and pressure (kPa). The fields present in a `(Data..)` record, and how often they are output, is determined by the `(Outputs..)` command.

Once it has established communications with a host computer (discussed in the next section), the instrument’s RS-232 communications is largely made of up of outgoing `(Data..)` and `(Diagnostics..)` records. The only other type of records it might send are `(Error..)` and `(Ack..)`. The `(Error..)` record is sent whenever the instrument receives a command it cannot parse or recognize, and the `(Ack..)` record acknowledges a configuration change. It is also used to pass back the new zero or span setting after a `(Calibrate..)` command.

Command Summary

In the following sections, some abbreviations are used:

{int} means an integer value, such as 0, 10, 452, etc.

{float} means any integer or floating point value, such as 0, 3.14159, 1E-7, -3.47e-09, etc.

{string} means anything (< 40 characters) contained by double quotes, such as "Hey, you!"

{ item1 | item2 | item3 } means you must include one of the items in the list.

{bool} - { TRUE | FALSE }

The (Outputs..) Command

(Outputs..) is used to configure the items pertaining to data output, including the bandwidth, delay time, DACs (digital to analog convertors), the RS-232 port, Ethernet and USB Logging. The actual RS-232 and Ethernet output uses the (Data..) record described in *Table D-2* on page D-8.

Table D-1. The Outputs Command

Command	Subcommands	Remarks	
(Outputs	(BW {5 10 20})) Sets instrument bandwidth to 5, 10, or 20 Hz.	
	(Delay {int})) Output delay interval (0 to 32), where each interval is 1/150 seconds. This is added to the 220 ms system delay.	
	(Dac1 (Dac2 (Dac3 (Dac4 (Dac5 (Dac6) (Source {List}) ¹)) (Zero {float}) (Full {float}))))))) The variable that drives the DACs (digital to analog convertors)
) Value that corresponds to 0 Volts output	
) Value that corresponds to 5 Volts output	
	(SDM (Address {int})) SDM address (0 thru 14).	

¹Auxiliary Outputs: { NONE | CO2A | CO2MMOL | H2OA | H2OMMOL | TEMPERATURE | PRESSURE | AUX | AUX2 | AUX3 | AUX4 | CO2MF | CO2MFD | H2OMF | H2OMFD | DEWPT | SETPOINT}

Command	Subcommands	Remarks	
(Outputs	(RS232 (Baud {9600 19200 38400})))	Baud rate for RS-232	
		(Freq {float})	Output frequency of (Data..) records in Hz. Usable values: 0.0 thru 20.0
		(Labels {bool})	
		(DiagRec {bool})	
		(EOL {"hex code(s)"})	User defined termination character(s) for data record in "hex" (e.g. "0D0A" would be carriage return line feed). Default is "0A" = line feed.
		{{List ¹ } {bool}}	These commands determine what is included in the (Data output record
	(ENet (Freq {float}))	(Labels {bool})	
		(DiagRec {bool})	
		(EOL {"hex code(s)"})	
		{{List ¹ } {bool}}	
		(Logging (Freq {1 2 5 10 20}))	
	(Split {0 15 30 60 90 120 240 1440})		
	(Zip {bool})		
	(Full { Delete DeleteAll Stop })		
	(7700Status {bool})		
	{{List ² } {bool}}		
	(Metadata {see below})		

¹Data Outputs: Ndx | Time | Date | CO2Raw | H2ORaw | DiagVal | DiagVal2 | CO2D | H2OD | Temp | Pres | Aux | Aux2 | Aux3 | Aux4 | Cooler | CO2MF | CO2Mfd | H2OMF | H2OMFd | DewPt | H2OAW | H2OAWO | CO2AW | CO2AWO | CO2SS

²Logging Outputs: Ndx | Time | Date | CO2Raw | H2ORaw | DiagVal | DiagVal2 | CO2D | H2OD | Temp | AvgTemp | TempIn | TempOut | Pres | APres | DPres | FlowPressure | MeasFlowRate | VolFlowRate | FlowPower | FlowDrive | Aux | Aux2 | Aux3 | Aux4 | Cooler | CO2MF | CO2Mfd | H2OMF | H2OMFd | DewPt | H2OAW | H2OAWO | CO2AW | CO2AWO | FlowPressure | FlowPower | FlowDrive | AvgSS | CO2SS | H2OSS | DeltaSS | SECONDS | NANOSECONDS | CH4 | CH4D | TEMP | PRESSURE | AUX1 | AUX2 | AUX3 | AUX4 |AUXTC1 | AUXTC2 | AUXTC3| RSSI | DROPRATE | AUXTCDIAG | DIAG

Command	Subcommands
(Metadata	(Log {bool}))
	(Site
	(site_name {string})
	(altitude {float})
	(gpsformat {DDD MM SS.SSS DDD MM.MMM Decimal Degrees})
	(latitude
	{+ - xxxd xx' xx.xxx"}
	{+ - xxxd xx.xxx'}
	{+ - xxx.xxx}
)
	(longitude
	{+ - xxxd xx' xx.xxx"}
	{+ - xxxd xx.xxx'}
	{+ - xxx.xxx}
)
	(canopy_height {float})
	(displacement_height {float})
	(roughness_height {float})
)
	(Station
	(station_name {string})
)
	(Instruments
	(instr_1_manufacturer {string})
	(instr_1_model {string})
	(instr_1_height {float})
	(instr_1_wformat {uvw polar_w axis})
	(instr_1_wref {spar axis})
	(instr_1_north_offset {float})
	(instr_2_manufacturer {string})
	(instr_2_model {string})
	(instr_2_height {float})
	(instr_2_north_separation {float})
	(instr_2_east_separation {float})
	(instr_2_vertical_separation {float})
	(instr_3_manufacturer {string})
	(instr_3_model {string})
	(instr_3_height {float})
	(instr_3_north_separation {float})
	(instr_3_east_separation {float})
	(instr_3_vertical_separation {float})

(EOL "{hex code(s)}")

End of Line character. Enter hex value in double quotes.

Example:

```
(Outputs (RS232 (EOL "0D0A"))) lf
```

would terminate data strings with a carriage return and a line feed.

(Ndx {bool})

Determines whether an index value is transmitted or not.

Example:

```
(Outputs (RS232 (Ndx TRUE))) lf
```

would cause the data stream to contain an index value. The index value is incremented approximately every 6.7 milliseconds (e.g. 150 Hz) and ranges from approximately -2.0E8 to +2.0E8.

(DiagRec {bool})

Controls whether independent (Diagnostic) text records are ever sent. If TRUE, operates normally (1/second or on a change). If FALSE, never sends a Diagnostic record.

Transmitted: (Outputs (RS232 (DiagRec TRUE))) lf

Received: (Diagnostics (SYNC TRUE) (PLL TRUE) (DetOK TRUE) (Chopper TRUE) (Path 61))

(DiagVal {bool})

Controls whether or not a 1 byte diagnostic value (0-255) is output (same as SDM diagnostic value) in the (Data stream. "Diag" is used for the label when (Labels TRUE is set.

Example:

Transmitted: (Outputs (RS232 (DiagVal TRUE))) lf

Received: (Data... (Diag 249...))

NOTE: The (DiagRec and the (DiagVal are two separate outputs and are independent of one another.

(Labels {bool})

This command controls whether or not data labels are transmitted with the data stream. Default is TRUE, and this means that data are transmitted in the normal (Data) format record. When (Labels FALSE), however, data output are values only and are tab-delimited. To maximize available bandwidth, when (Labels FALSE), a data record might appear as

```
15.1234<tab>354.123<tab>101.3<tab>249<eol>
```

The following are several examples of data formatting. The command string sent to the instrument is terminated with a line feed character.

EXAMPLE (Labels TRUE) Data format

Transmitted to instrument

```
(Outputs(RS232(Freq 1)(EOL "OD0A")(Ndx TRUE)(DiagRec FALSE)
(DiagVal TRUE)(Labels TRUE)))lf
```

Received from the instrument

```
(Data (Ndx 1545) (DiagVal 250) (CO2Raw 1.5386712e-1) (CO2D
3.2183277e1) (H2ORaw 3.5775542e-2) (H2OD 1.9687008e2) (Temp
2.4227569e1) (Pres 9.8640356e1) (Aux 0) (Cooler 1.5756724)) (Data
(Ndx 1809) (DiagVal 250) (CO2Raw 1.5380490e-1) (CO2D 3.2162146e1)
(H2ORaw 3.5757541e-2) (H2OD 1.9677452e2) (Temp 2.4227569e1) (Pres
9.8543587e1) (Aux 0) (Cooler 1.5750400))
```

EXAMPLE (Labels FALSE) Data format

Notice how this format is much cleaner and reduces the overhead of redundant label transmissions. The data selected for output data record is accomplished with the (Outputs(RS232(CO2Raw TRUE)...)) command.

Transmitted to the instrument

```
(Outputs(RS232(Freq 1)(EOL "OD0A")(Ndx TRUE)(DiagRec FALSE)
(DiagVal TRUE)(Labels FALSE)))lf
```

Received from the instrument

```
252 250 0.15401 32.2167 0.03569 196.703 24.33 98.6 0 1.5730
```

```

511 250 0.15404 32.2174 0.03572 196.816 24.42 98.5 0 1.5683
765 250 0.15402 32.2342 0.03579 196.995 24.49 98.6 0 1.5703
1033 250 0.15400 32.2097 0.03571 196.771 24.63 98.5 0 1.5724
1288 250 0.15405 32.2341 0.03578 196.838 24.76 98.5 0 1.5734
1544 250 0.15406 32.2385 0.03575 196.782 24.72 98.5 0 1.5724

```

Examples:

To set the instrument to output only CO₂ and H₂O molar densities once every 2 seconds:

```
(Outputs(RS232(Freq .5)(Pres FALSE)(Temp FALSE)(Aux FALSE)(CO2Raw
FALSE)(CO2D TRUE)(H2ORaw FALSE)(H2OD TRUE)(Cooler FALSE))
```

To configure DAC #1 to output CO₂ mole density with this scaling: 0V = 12 mmol m⁻³, and 5V = 15 mmol m⁻³.

```
(Outputs(Dac1(Source CO2MMOL)(Zero 12)(Full 15))
```

Data and Status Records

The (Data..) and (Diagnostics..) records are the vehicles with which the instrument outputs data through its RS-232 port. The frequency with which it outputs (Data..) records is determined by the (Outputs(RS232(Freq..)) command. Data and status record formats are determined by the (Outputs(RS232 {boolean} controlled command structure. (EOL {"hex codes"})) and (Labels {boolean}) determine the termination characters and whether or not (Data labels are output.

Table D-2. Data and Diagnostic Records

Record	Subcommands	Remarks
(Data	(Ndx {int})	Index value. Increments by 150 every second.
	(Time {})	Time
	(Date {})	Date
	(Temp {float})	Block temperature, °C
	(Pres {float})	Total pressure, kPa
	(Aux {float})	Auxiliary input value
	(Aux2 {float})	Auxiliary input value 2
	(Aux3 {float})	Auxiliary input value 3
	(Aux4 {float})	Auxiliary input value 4
		The values included are set by (Outputs(...)). How often this is output is determined by (Outputs (Freq...)).

Table D-2. Data and Diagnostic Records (...continued)

Record	Subcommands	Remarks		
(Data	(CO2AW {float}))	CO ₂ Source	The values included are set by (Outputs(...)). How often this is output is determined by (Outputs (Freq...)).
	(CO2AWO {float})		CO ₂ Reference	
	(CO2Raw {float})		CO ₂ absorptance	
	(CO2D {float})		CO ₂ density (mmol m ⁻³)	
	(CO2MF {float})		CO ₂ mol fraction (μmol/-mol)	
	(H2OAW {float})		H ₂ O Source	
	(H2OAWO {float})		H ₂ O Reference	
	(H2ORaw {float})		H ₂ O absorptance	
	(H2OD {float})		H ₂ O density (mmol m ⁻³)	
	(H2OMF {float})		H ₂ O mol fraction (mmol/-mol)	
	(Cooler {float})		Detector cooler (Volts)	
	(DiagVal {int})		Diagnostic value 0-255. Boolean controlled output	
	(Data		(DiagVal2 {int})	
(AvgSS {float})		Average Signal Strength		
(CO2SS {float})		CO ₂ Signal Strength		
(H2OSS {float})		H ₂ O Signal Strength		
(DeltaSS {float})		CO ₂ Signal Strength – H ₂ O Signal Strength		

Record	Subcommands	Remarks
(Diagnostics	(Path {float})) Average Signal Strength (0-100) Diagnostics are always output at 1 Hz
	(Synch {bool})	
	(PLL {bool})	
	(DetOK {bool})	
	(Chopper {bool})	
	(PDif {bool})	
	(AuxIn {bool})	
	(Head {1 0})	
(Ack	(Received TRUE)) Sent by the instrument to acknowledge any incoming command.
	(Val {float})	
(Error (Received TRUE))		Sent by the instrument when it cannot parse or recognize a command.
(EmbeddedSW	(Version {string})) Embedded software version Instrument model, e.g., LI-7500RS Embedded DSP software version Embedded FPGA software version
	(Model {string})	
	(DSP {string})	
	(FPGA {string})	
(Command {start_logging stop_logging eject_usb factory_reset})		
(Info (USB	(Size {float})) 0: Drive not present 1: Logging 2: Drive present, not logging 3: Error
	(Free {float})	
	(State {0 1 2 3})	

Examples:

A typical (Data..) output record, with all items present, is shown below:

```
(Data (Ndx 215713) (CO2Raw 1.2831902e-1) (CO2D 2.2083146e1) (H2ORaw
5.5372476e-2) (H2OD 3.5485935e2) (Temp 2.5886261e1) (Pres
9.8157062e1) (Aux 0) (Cooler 1.0537354))
```

A typical (Diagnostics..) record is shown below:

```
(Diagnostics (Sync TRUE) (PLL TRUE) (DetOK TRUE) (Chopper TRUE) (Path
63))
```

Data Polling (Software and Hardware)

A software command using the ENQ character (0x05) is available to query the instrument for a data record over RS-232. When transmitted to the instrument, via RS-232, the record is built as presently defined (Labels TRUE or FALSE, etc.), and is added to the serial output queue. This software command is normally used when the update frequency is set to zero, as shown in the command below.

```
(Outputs (RS232 (Freq 0) (DiagRec FALSE)))lf
```

The instrument also supports toggling of the Clear To Send (CTS) line to request a data record. This hardware polling would be normally used when the update frequency is set to 0 as described above. Since the CTS line is an input, the host software should toggle the Request To Send (RTS) line from the host computer. This method of transmitting a data record occurs when the CTS line goes from low to high.

Users familiar with programming RS-232 interfaces may already understand that RS-232 logic TRUE (1) is considered a low (or negative) voltage and logic FALSE (0) is considered a high (or positive) voltage. Thus, the CTS toggle sequence would look like:

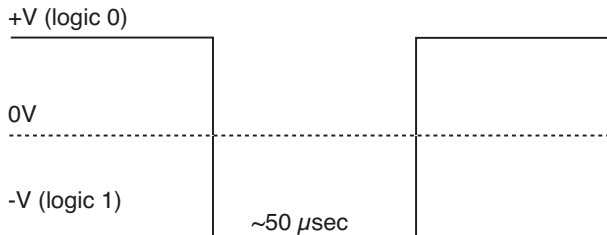

Data are updated to RS-232 at 20 Hz. If the CTS line is toggled, record will be output the next time one is ready. The CTS line is pin 7 on the LI-COR RS-232 Cable, part number 392-10268. The RS-232 serial pin-out from a DB9 connector on an AT style computer is defined as:

Pin	Signal Description	Function	Signal at Device
1	DCD	Data Carrier Detect	Input
2	RD	Received Data	Input
3	TD	Transmit Data	Output
4	DTR	Data Terminal Ready	Output
5	SG	Signal Ground	
6	DSR	Data Set Ready	Input
7	RTS	Request To Send	Output
8	CTS	Clear To Send	Input
9	RI	Ring Indicator	Input

A possible wiring configuration using the LI-COR RS-232 cable, part number 392-10268 to a computer would be:

LI-COR CABLE	DB9 ON HOST COMPUTER	LI-COR CABLE
Function	PIN	Function
Ground	PIN 5	Ground
Receive Data	PIN 3	Transmit Data
Request To Send	PIN 8	Clear To Send
Transmit Data	PIN 2	Receive Data
Clear To Send	PIN 7	Request To Send
Data Terminal Ready	PIN 6	Data Set Ready

Note about Embedded Software RS-232 Communication Priorities

The RS-232 hardware and software trigger does not tap directly into the same data stream that is output to the DAC's and the SDM. The trigger actually sends a request to the instrument to output a single data record over the RS-232 port. The processing that is incurred to do this is relatively lengthy. The RS-232 task is also a low priority, so considerable latency could occur. If you want output data that is tightly synchronized to an input stimulus you should use the SDM output or sample a DAC output based on your trigger; don't use RS-232.

The (Inputs..) Command

The (Inputs..) command is used to scale the Auxiliary input channel, and to determine how pressure and temperature are measured by the instrument.

Table D-3. The Inputs Command.

Command	Subcommands			Remarks				
(Inputs	(Pressure	(Source { Aux)	How it is determined				
		(Temperature)					
		(Measured User-			Fixed value, for "UserEntered"			
		Entered }						
		(Val {float})						
	(Aux	(A {float}))			A and B are the Slope and Intercept respectively		
		(B {float})						
		(Name{string})						
		(Units{string})						
	(Aux2	(A {float}))				Name: Used to denote the type of input. For example, U, V, W, Ts.	
		(B {float})						
		(Name{string})						
		(Units{string})						
	(Aux3	(A {float}))					Units: The units of the data after the slope and intercept are applied.
		(B {float})						
		(Name{string})						
(Units{string})								
(Aux4	(A {float}))						
	(B {float})							
	(Name{string})							
	(Units{string})							

Examples:

To make pressure fixed at 92 kPa, send this:

```
(Inputs (Pressure (Source UserEntered) (Val 92) ) )
```

To measure temperature from a linearized thermistor connected to the Auxiliary input, where 0 volts is 0 °C, and 5 volts is 50 °C, send this:

```
(Inputs (Aux (A 10) (B 0) ) (Temperature (Source Aux) ) )
```

To measure pressure and temperature normally, using the built-in sensors, send this:

```
(Inputs (Pressure (Source Measured) ) (Temperature (Source Measured) ) )
```

The (Calibrate...) and (Coeffs...) Commands

The (Calibrate..) and (Coeffs..) commands control zeroing, spanning, and factory calibration coefficients. The (Date subcommand must be present, and (Val must be absent to perform (ZeroH2O and (ZeroCO2. For (SpanCO2 and (SpanH2O, (Date and (TDensity must be present, and (Val must be absent to trigger a calibration.

Table D-4. Calibration Commands.

Command	Subcommands			Remark
(Calibrate	(ZeroH2O (ZeroCO2	(Val {float})))	For setting the zero directly. If not present will trigger a calibration.
		(Date {quoted string})		The date field triggers the instrument to do a zero immediately. The new value will be returned in an (Ack..) record.
	(SpanCO2 (Span2CO2 (SpanH2O (Span2H2O	(Val {float})))	For setting the span directly. If not present will trigger a calibration.
		(Target {float})		Target value in ppm for CO ₂ , or °C for H ₂ O (for reference purposes).
		(TDensity {float})		Target value in mmol m ⁻³ . (For computational purposes).
		(Date {quoted string})		
	(MaxRef	(CX {int})))	Maximum expected value of raw reference signal Aco at -40 °C.
		(WX {int})		Maximum expected value of raw reference signal Awo at -40 °C.
		(Date {quoted string})		

Command	Subcommands	Remark	
(Coeffs	(Current	(SerialNo { <i>quoted string</i> })) The 72H-xxxx head number.
		(Band (A { <i>float</i> }))	
	(CO2	(A { <i>float</i> })) These values are found on the instrument calibration sheet.
		(B { <i>float</i> })	
		(C { <i>float</i> })	
		(D { <i>float</i> })	
		(E { <i>float</i> })	
		(XS { <i>float</i> })	
		(Z { <i>float</i> })	
	(H2O	(A { <i>float</i> })) These values are found on the instrument calibration sheet.
		(B { <i>float</i> })	
		(C { <i>float</i> })	
		(XS { <i>float</i> })	
		(Z { <i>float</i> })	
	(Pressure	(A0 { <i>float</i> })	
(A1 { <i>float</i> })			
(MaxRef	(B { <i>float</i> })		
	(C { <i>float</i> })		

Examples:

1. To set the CO₂ zero right now (with CO₂-free gas flowing though it, of course), send this:

```
(Calibrate(ZeroCO2(Date "11 Aug 1999 at 2:15")))
```

Note 1: The data value can be any string, so "My Birthday" is equally valid.

Note 2: The new value of zero will be sent in the next (Ack(Val..)) record. (See Table 2).

2. To force the H₂O channel to use the value 0.96 for its zero, send this:

```
(Calibrate(ZeroH2O(Val 0.96)))
```

3. To make the instrument set its CO₂ span right now, with 400 μmol mol⁻¹ flowing through the calibration tube, first compute the target density using equation 8-24 (solved for C).

If the temperature is 23°C, and the pressure 98kPa, then the mode density is 15.92 mmol CO₂ m⁻³. Then send the following:

```
(Calibrate(SpanCO2(Target 400)(Tdensity 15.92)(Date "14 Sept 2015")))
```

The Program Reset Command

(Program (Reset TRUE)) is the equivalent of pressing the reset button on the main board. It is generally only used to access lower level software for updating the embedded program, or when the instrument is not responding normally.

Table D-5. Synchronization Commands

Command	Remarks
(Program (Reset TRUE))	Sending this will force the software to reset. This is equivalent to pressing the reset button on the LI-7550 inside panel.

The Network Command

Table D-6. Network Commands

Command	Subcommands	Remarks
(Network	(Name {string}))	Hostname
	(IP (Type {dhcp static}))	Address type: dhcp static
	(Address {xxx.xxx.xxx.xxx})	
	(Netmask {xxx.xxx.xxx.xxx})	
	(Gateway {xxx.xxx.xxx.xxx})	
	(MAC {xx:xx:xx:xx:xx:xx})	

The Clock Command

Command	Subcommands	Remarks
(Clock	(Date {})	System date
	(Time {})	System time
	(PTP {off automatic slaveonly preferred})	Precision Time Protocol setting
	(Zone { ¹ })	Time zone

¹Refer to the PC software for list of time zones.

The Query Command

The Query (?) command is used to query the instrument for any configuration parameter individually, as well as any node in the configuration tree.

Table D-7. Query Commands

Command	Remarks
(Outputs ?) (Calibrate ?) (Coef ?) (Outputs ?) (Data ?) (Diagnostics ?) (EmbeddedSW ?) (Inputs ?) (Info ?) (Network ?) (MeteoDevices ?) (MeteoSensors ?)	The query for individual parameters works only for configuration parameters and not data or diagnostic information. All commands are followed by a line feed (lf).

Examples:

The query (**Outputs(RS232(Freq ?))**)If would respond:

```
(Outputs (RS232 (Freq 5)))
```

whereas the query (**Calibrate ?**)If causes a Calibrate record to be put in the output queue.

Example Response:

```
(Calibrate (ZeroCO2 (Val 0.8945) (Date 26 08 2009 10:37)) (SpanCO2
(Val 1.0068) (Target 597.2) (Tdensity 23.154) (Date 26 08 2009
11:00)) (Span2CO2 (Val 0.0) (Target ) (Tdensity ) (ic 0.106207) (act
0.105489) (Date 4Cal)) (ZeroH2O (Val 0.791075) (Date 26 08 2009
11:20)) (SpanH2O (Val 1.00585) (Target 12.00) (Tdensity 447.421)
(Date 26 08 2009 11:37)) (Span2H2O (Val 0.0) (Target ) (Tdensity )
(iw 0.059434) (awt 0.0590885) (Date 4Cal)))
```

(**Coef ?**)If causes a Coefficients record to be put in the output queue.

Example Response:

```
(Coef (Current (SerialNo 75H-Beta6) (Band (A 1.15)) (CO2 (A
1.56704E+2) (B 2.15457E+4) (C 4.33894E+7) (D -1.24699E+10) (E
1.75102E+12) (XS 0.0023) (Z 0.0002)) (H2O (A 5.24232E+3) (B
3.91896E+6) (C -2.33026E+8) (XS -0.0009) (Z 0.0185)) (Pressure (A0
56.129) (A1 15.250)) (DPressure (A0 1.0) (A1 0.0))))
```

(Outputs ?)If causes a Outputs record to be put in the output queue.

Example Response:

```
(Outputs (BW 10) (Delay 0) (SDM (Address 7)) (Dac1 (Source NONE)
(Zero -5e-2) (Full 4e-1)) (Dac2 (Source PRESSURE) (Zero -1e-1) (Full
4e-1)) (RS232 (Baud 38400) (Freq 0) (Pres TRUE) (Temp TRUE) (Aux TRUE)
(Cooler TRUE) (CO2Raw TRUE) (CO2D TRUE) (H2ORaw TRUE) (H2OD TRUE) (Ndx
TRUE) (DiagVal TRUE) (DiagRec FALSE) (Labels FALSE) (EOL "0D0A")))
```

(Data ?)If causes a Data record to be put in the output queue. (Note that an ENQ (0x05) will do the same thing...)

Example Response:

```
(Data (Ndx 2471) (DiagVal 250) (CO2Raw 1.6319131e-1) (CO2D
3.5119712e1) (H2ORaw 3.1672954e-2) (H2OD 1.7067077e2) (Temp
2.3874512e1) (Pres 9.8735609e1) (Aux 0) (Cooler 1.5630015))
```

(Diagnostics ?)If causes a Diagnostics record to be put in the output queue.

Example Response:

```
(Diagnostics (SYNC TRUE) (PLL TRUE) (DetOK TRUE) (Chopper TRUE) (Path
65))
```

(EmbeddedSW ?)If causes an EmbeddedSW record to be put in the output queue.

Example Response:

```
(EmbeddedSW (Version 4.0.0) (Model LI-7500RS CO2/H2O Analyzer) (DSP
4.0.0) (FPGA 4.0.0|))
```

(Inputs ?)If causes an Inputs record to be put in the output queue.

Example Response:

```
(Inputs (Pressure (Source Measured) (UserVal 9.8000002e1)) (Tem-
perature (Source Measured) (UserVal 2.5000000e1)) (Aux (A 1) (B 0)))
```

MeteoDevices (Biomet Station)

Command	Subcommands	Remarks
(MeteoDevices	(DevList {string:string...}))	Colon delimited list of devices on the network (sub-net)
	(Device {string})	Current connected device
	(DeviceState {0 1})	0=not connected 1=connected
	(SyncClock {bool})	When TRUE, the clock on the 9210B will get updated with the time of the LI-7550

The Connection Protocol

The purpose of this section is to describe the protocol used to establish communications with the instrument when it is operating in an “unknown” mode. That is, when the baud rate is not known, nor are any other details about the instrument’s configuration.

For simple data collection, the instrument can be configured with the PC software, and you will not have to deal with this protocol at all. If you want to write your own interface program or driver for the instrument, and you want to get the instrument to send its configuration to you, then this protocol must be used.

Establishing Communications: Step by Step

- 1.** Set a break condition on the RS-232 line. 500 ms should be sufficient.

The instrument will cease normal activity, change its baud rate to 9600 baud, and begin to send ascii ENQ characters (decimal 05) at a rate of 2 Hz for up to 10 seconds. Before 10 seconds are up, the host should:

- 2.** Send an ascii ACK character (decimal 06) to the instrument.

Upon receipt of an ACK, the instrument will output its current configuration, terminated with a line feed (decimal 10). After this is sent, the instrument will resume its normal operation, except it will remain at 9600 baud.

- 3.** The host can then send the desired configuration changes, if any, to the instrument.
- 4.** If the configuration change involves a baud rate change, the instrument will send its (Ack..) record before changing baud rates.

Appendix E. Warranty

Each LI-COR, inc. instrument is warranted by LI-COR, inc. to be free from defects in material and workmanship; however, LI-COR, inc.'s sole obligation under this warranty shall be to repair or replace any part of the instrument which LI-COR, inc.'s examination discloses to have been defective in material or workmanship without charge and only under the following conditions, which are:

1. The defects are called to the attention of LI-COR, inc. in Lincoln, Nebraska, in writing within one year after the shipping date of the instrument.
2. The instrument has not been maintained, repaired or altered by anyone who was not approved by LI-COR, inc.
3. The instrument was used in the normal, proper and ordinary manner and has not been abused, altered, misused, neglected, involved in an accident or damaged by act of God or other casualty.
4. The purchaser, whether it is a DISTRIBUTOR or direct customer of LI-COR or a DISTRIBUTOR'S customer, packs and ships or delivers the instrument to LI-COR, inc. at LI-COR inc.'s factory in Lincoln, Nebraska, U.S.A. within 30 days after LI-COR, inc. has received written notice of the defect. Unless other arrangements have been made in writing, transportation to LI-COR, inc. (by air unless otherwise authorized by LI-COR, inc.) is at customer expense.
5. No-charge repair parts may be sent at LI-COR, inc.'s sole discretion to the purchaser for installation by purchaser.
6. LI-COR, inc.'s liability is limited to repair or replace any part of the instrument without charge if LI-COR, inc.'s examination disclosed that part to have been defective in material or workmanship.

There are no warranties, express or implied, including but not limited to any implied warranty of merchantability of fitness for a particular purpose on underwater cables or on expendables such as batteries, lamps, thermocouples, and calibrations.

Other than the obligation of LI-COR, inc. expressly set forth herein, LI-COR, inc. disclaims all warranties of merchantability or fitness for a particular purpose. The foregoing constitutes LI-COR, inc.'s sole obligation and liability with respect to damages resulting from the use or performance of the instrument

and in no event shall LI-COR, inc. or its representatives be liable for damages beyond the price paid for the instrument, or for direct, incidental or consequential damages.

The laws of some locations may not allow the exclusion or limitation on implied warranties or on incidental or consequential damaged, so the limitations herein may not apply directly. This warranty gives you specific legal rights, and you may already have other rights which vary from state to state. All warranties that apply, whether included by this contract or by law, are limited to the time period of this warranty which is a twelve-month period commencing from the date the instrument is shipped to a user who is a customer or eighteen months from the date of shipment to LI-COR, inc.'s authorized distributor, whichever is earlier.

This warranty supersedes all warranties for products purchased prior to June 1, 1984, unless this warranty is later superseded. To the extent not superseded by the terms of any extended warranty, the terms and conditions of LI-COR's Warranty still apply.

DISTRIBUTOR or the DISTRIBUTOR's customers may ship the instruments directly to LI-COR if they are unable to repair the instrument themselves even though the DISTRIBUTOR has been approved for making such repairs and has agreed with the customer to make such repairs as covered by this limited warranty.

Further information concerning this warranty may be obtained by writing or telephoning Warranty manager at LI-COR, inc.

Index

A

Advanced Eddy Covariance Flux Processing, 3-49
Analog Inputs, **See** Auxiliary Inputs
Anemometer, **See** Sonic Anemometer
Ascarite II, 5-4
Auxiliary Inputs
 configuring, 7-10
Auxiliary Sensor Interface, 2-9
 about connections, 2-11
 connecting sensors, 2-11
 mounting, 2-9
 terminals, 2-10

B

Backup, 3-52
Bandwidth, 7-19
Baud Rate
 set, 3-3
Biomet
 about, 3-33
 connecting, 3-33

C

Cables
 connection panel, 1-7
 custom lengths, C-2
Calibration, 7-21
 coefficients, 7-22
 history, 7-24
 restore, 7-24
Cell Pressure, 8-7
Cell Temperature, 8-7
Charts, 7-30

Chopper Housing Temperature, 7-7
Clock, 7-1, 7-2
 GPS, 3-16
Commands, D-2, D-8
 biomet sensors, D-19
Compression, 3-17, 3-37
Configuration Files, 7-33
Connecting
 Biomet system, 3-33
 LI-7700, 3-30
Cross-sensitivity
 correction, 8-3

D

Data
 inputs, 7-10
 logging, 3-17
 outputs, 7-12
 polling, D-11
Data Backup, 3-52
Desiccant, 4-2
Dessiccant, 5-4
Dew, 2-7
Diagnostic
 indicators, 7-25
 test point, 7-26
Dust, 2-8

E

Eastward Separation, 3-28, 3-31
Eddy Covariance
 CH4 Log Values, 3-32
 CO2/H2O Log Values, 3-29
 file description, 3-38
 gas analyzer information, 3-27

- instruments, 3-13
- logging datasets, 3-17
- Site Setup, 3-13
- sonic anemometer inputs, 3-21
- EddyPro
 - advanced mode, 3-42
- Equations, 8-6
 - absorptance, 8-2
- Ethernet Cable
 - connection, 3-33
- Ethernet Communication
 - about, 3-1
- Ethernet Connection, 7-14

F

- File Compression, 3-37
- Formulas, 8-6
- Fuse
 - replacing, 5-3

G

- GHG file
 - defined, 3-5
- GHG Software, 3-1
 - update, 7-33
- GPS
 - clock, 3-16
 - format, 3-19
- Grammer, D-1
- Graphs, 7-30

H

- Heads
 - interchanging, 7-24

I

- In-situ Spectral Corrections, 3-49
- Installing
 - LI-7550 Analyzer Interface Unit, 2-4
 - Windows software, 3-1
- Integration, 7-8

L

- LI-7550
 - about, 1-6
- LI-7700
 - connecting, 3-30
- Logging Data
 - important note, 3-36
 - start, 3-36
 - to a personal computer, 7-32

M

- Meteorological measurements, 3-33

N

- Network Settings, 7-4
- Northward Separation, 3-28, 3-31

O

- Output
 - DAC, 7-15
 - Ethernet, 7-14
 - rates, 7-13
 - RS-232 Serial, 7-13

P

- Planar Fit, 3-49
- Plots, 7-30
- Pollen, 2-8
- Port, 3-1
- Power
 - connecting, 2-2
- Pressure
 - errors, 6-3
- PTP Clock, 3-16, 7-2

R

- Rain/Snow, 2-7
- Results Files, 3-52
- RS-232
 - connect, 3-3
 - pin assignments, B-1

S

- Salt Deposites, 2-8
- Secondary Span, 4-8
 - CO₂, 4-8
 - H₂O, 4-9
- Sensor Separation, 3-28, 3-31
- Serial Connection, 3-3
- Signal Strength, 7-22, 8-7
- Site Information
 - entering, 3-18
- SMARTFlux
 - advanced mode, 3-42
 - clock, 3-16
 - configuration file, 3-51
 - connect, 3-35
- Soda Lime, 5-4
- Software Update
 - GHG, 7-33
 - LI-7200RS, 7-33
 - LI-7500RS, 7-33
- Sonic Anemometer
 - inputs, 3-23
- Sonic Anemometer Information, 3-20
- Span
 - about, 4-3
 - command, D-14
 - secondary, 4-8
 - secondary CO₂, 4-8
 - secondary H₂O, 4-9
 - stability, 4-1
- Spectral Corrections, 3-49
- Subnet, 3-1
- Summer Setting, 7-7
- Sutron, 3-33

T

- Temperature
 - errors, 6-3
- Time, 7-1
 - about, 7-2
- Timelag, 3-49
- Transmit Data, D-7

- Troubleshooting, 6-1, 6-4

U

- USB
 - logging, 3-37
 - settings, 3-36

V

- Vertical Separation, 3-28, 3-31
- Vibrations, 2-8

W

- Windows Software, 3-1
- Winter Setting, 7-7

X

- XML, D-1, D-2, D-8
 - example commands, D-14
 - sending commands, 7-7

Z

- Zero
 - checking, 4-2
 - command, D-14
 - stability, 4-1

LI-COR Biosciences

Global Headquarters

4647 Superior Street
Lincoln, Nebraska 68504
Phone: +1-402-467-3576
Toll free: 800-447-3576
Fax: +1-402-467-2819
envsales@licor.com • envsupport@licor.com • www.licor.com/env

Regional Offices

LI-COR GmbH, Germany

Serving Andorra, Albania, Cyprus, Estonia, Germany, Iceland, Latvia, Lithuania, Liechtenstein, Malta, Moldova, Monaco, San Marino, Ukraine, and Vatican City.
LI-COR Biosciences GmbH
Siemensstraße 25A
61352 Bad Homburg
Germany
Phone: +49 (0) 6172 17 17 771
Fax: +49 (0) 6172 17 17 799
envsales-gmbh@licor.com • envsupport-gmbh@licor.com

LI-COR Ltd., United Kingdom

Serving Denmark, Finland, Ireland, Norway, Sweden, and UK.
LI-COR Biosciences UK Ltd.
St. John's Innovation Centre
Cowley Road
Cambridge
CB4 0WS
United Kingdom
Phone: +44 (0) 1223 422102
Fax: +44 (0) 1223 422105
envsales-UK@licor.com • envsupport-UK@licor.com

LI-COR Distributor Network: www.licor.com/env/distributors

984-15811

LI-COR®