



# LI-7700

Open Path CH<sub>4</sub> Analyzer

Instruction Manual

**LI-COR**<sup>®</sup>

Biosciences

# **LI-7700**

## **Open Path CH<sub>4</sub> Analyzer**

### **Instruction Manual**

LI-COR, Inc.  
4647 Superior Street  
P.O. Box 4425  
Lincoln, NE 68504-0425

Telephone: (402) 467-3576  
FAX: 402-467-2819  
Toll Free: 1-800-447-3576 (U.S. & Canada)  
Email: [envsales@licor.com](mailto:envsales@licor.com)  
[envsupport@licor.com](mailto:envsupport@licor.com)  
[www.licor.com](http://www.licor.com)

***LI-COR***<sup>®</sup>

Biosciences

---



Biosciences

■ LI-COR, Inc.  
Environmental  
4647 Superior Street  
P.O. Box 4000  
Lincoln, Nebraska 68504 USA

■ Phone: 402-467-3576  
FAX: 402-467-2819  
Information: 1-800-447-3576 (Toll-free U.S. & Canada)  
E-mail: envsales@env.lincor.com

---

## Declaration of Conformity

**Manufacturer's Name:** LI-COR, Inc.

**Manufacturer's Address:** 4647 Superior Street  
Lincoln, Nebraska USA 68504

**declares that the product**

**Product Name:** Open Path CH<sub>4</sub> Gas Analyzer

**Model Number(s):** LI-7700

**Product Options:** None

**conforms to the following Product Specifications:**

EMC: EN 55011 : 2002 Radiated Emissions, Class A  
IEC 61000-4-2 : 2000 ESD, 4KV/8KV Contact/Air  
IEC 61000-4-3 : 2002 Radiated RF Immunity, 10V/m  
IEC 61000-4-4 : 2004 EFT/Burst  
IEC 61000-4-5 : 2000 Surge Immunity, 1KV  
IEC 61000-4-6 : 2003 Conducted RF Immunity, 3V

**Supplementary Information:**

The product herewith complies with the requirements of the EMC Directive 2004/108/EC.

John Rada  
Director of Engineering

Document #53-11453  
February 9, 2010

## NOTICE

The information contained in this document is subject to change without notice. LI-COR MAKES NO WARRANTY OF ANY KIND WITH REGARD TO THIS MATERIAL, INCLUDING, BUT NOT LIMITED TO THE IMPLIED WARRANTIES OF MERCHANTABILITY AND FITNESS FOR A PARTICULAR PURPOSE. LI-COR shall not be liable for errors contained herein or for incidental or consequential damages in connection with the furnishing, performance, or use of this material.

This document contains proprietary information, which is protected by copyright. All rights are reserved. No part of this document may be photocopied, reproduced, or translated to another language without prior written consent of LI-COR, Inc.

The LI-7700 is covered by U.S. patents, patents pending and foreign equivalents.

LI-COR has licensed certain aspects of the LI-7700 that were developed with expertise from Southwest Sciences, Inc. (Santa Fe, NM). This project was funded in part by the US Department of Energy through a Small Business Innovation Research grant (DE-FG02-05ER84283).

Microsoft® and Windows® are registered trademarks of Microsoft Corporation. Eurofast® is a registered trademark of Turck®, Inc. All other trademarks are property of their respective owners.

LI-COR, Inc. • 4647 Superior Street • P.O. Box 4425 • Lincoln, Nebraska 68504  
Phone: 402-467-3576 • FAX: 402-467-2819  
Toll-free: 1-800-447-3576 (U.S. & Canada)  
[envsales@licor.com](mailto:envsales@licor.com) • [www.licor.com](http://www.licor.com)

---

### Printing History

New editions of this manual will incorporate all material since the previous editions. Update packages may be used between editions that contain replacement and additional pages to be merged into the manual by the user. The manual printing date indicates its current edition. The printing date changes when a new edition is printed. (Minor corrections and updates that are incorporated at reprint do not cause the date to change).

© Copyright 2010, LI-COR, Inc.

Publication No. 984-10751

1<sup>st</sup> Printing – February 2010

2<sup>nd</sup> Printing – October 2010

## Notes on Safety

This LI-COR product was designed to be safe when operated in the manner described in this manual. The safety of the product cannot be guaranteed if the product is used in any other way than is specified in this manual.

### Equipment markings:

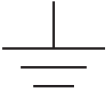

The LI-7550 is marked with this symbol for a chassis ground connection.

### Manual markings:

- Warning:**        **Warnings** are to warn about the possibility of minor injury to yourself or others.
- Caution:**        **Cautions** must be observed in order to prevent damage to your equipment.
- Important:**        **Important** indicates information that will help prevent procedural mistakes in the operation of the equipment or related software. Failure to comply may result in poor experimental outcomes but will not cause bodily injury or equipment damage.
- Note:**            **Notes** contain important information and useful tips on the operation of your equipment.

# Table of Contents

Welcome... x

---

## **1 General Information 1-1**

---

Overview of the LI-7700..... 1-1

What's What ..... 1-2

    The LI-7700 Open Path CH<sub>4</sub> Analyzer ..... 1-2

    Spares Kit and Cables ..... 1-3

    7550-101 Auxiliary Sensor Interface (optional) ..... 1-5

    Sonic Anemometer Interface Cables (optional)..... 1-5

    LI-7550 Analyzer Interface Unit (optional) ..... 1-6

LI-7700 Components and Connections..... 1-7

Basic Setup..... 1-9

    Install the LI-7700 Computer Software ..... 1-9

    Power On ..... 1-9

    Connect the Ethernet Data Cable ..... 1-10

    Launch the Software and Connect to an LI-7700..... 1-11

Mirrors - Cleaning and Care ..... 1-12

---

## **2 Operation 2-1**

---

Introduction to the LI-7700 Interface Software ..... 2-1

    Main View ..... 2-1

        Tool Bar ..... 2-2

        Settings Bar ..... 2-3

        Charting Pages ..... 2-3

    Charting..... 2-4

Configuring the LI-7700..... 2-6

PC/Network Data Logging (Ethernet Output) .....	2-6
Logging Status Columns .....	2-7
Splitting Files.....	2-7
Operating Temperature Range .....	2-8
Manual Controls .....	2-9
Configuring Mirror Heater Controls.....	2-10
Configuring the Spin Motor Control .....	2-12
Instrument Name and Address .....	2-15
Setting the Time .....	2-16
Output Rate .....	2-18
Configuration Files.....	2-19
Creating an Instrument Configuration File .....	2-19
Implementing a Configuration File .....	2-19
LI-7700 Analog Inputs .....	2-20
Auxiliary Sensor Interface Terminals (Option 1) .....	2-21
Connecting Sensors to the Auxiliary Sensor Interface .....	2-23
Thermocouple Inputs .....	2-24
Configuring Auxiliary Inputs (LI-7700).....	2-25
Deploying the LI-7700 and Accessories.....	2-27
Mounting the LI-7700 .....	2-27
Vibrations .....	2-27
Positioning the LI-7700 .....	2-28
Grounding .....	2-29
Mounting the 7550-101 Auxiliary Sensor Interface.....	2-29
Attaching the Mirror Cleaner/Washer Assembly .....	2-30
Mounting the Washer Reservoir .....	2-31

---

### **3 Operation with the LI-7550 Analyzer Interface Unit 3-1**

---

Introduction to the LI-7550.....	3-1
What's What .....	3-2
Spares Kit and Cables.....	3-2
Cable Connections.....	3-4
Basic Setup.....	3-6
Power On .....	3-6
Connecting to the LI-7700 and LI-7550 (Ethernet) .....	3-6
Getting an LI-7700 to talk to an LI-7550.....	3-7
Using an LI-7700 with an LI-7500A or LI-7200 CO <sub>2</sub> /H <sub>2</sub> O Analyzer.....	3-9
Connecting to the LI-7700 and LI-7550 (RS-232 Serial).....	3-11

Using the LI-7550 .....	3-12
USB Data Logging .....	3-12
About USB Devices.....	3-14
USB Storage Capacity .....	3-14
Analog Inputs (LI-7550) .....	3-15
Auxiliary Sensor Interface Terminals (Option 2) .....	3-16
Electrical Connections.....	3-18
Analog Input Time Delays.....	3-19
LI-7550 Clock.....	3-20
LI-7550 Outputs .....	3-21
Ethernet .....	3-21
SDM .....	3-21
RS-232.....	3-25
Analog.....	3-26
Analog Output Time Delays.....	3-27
Analog Output Hardware Configuration (Option 3).....	3-27
Mounting the LI-7550 Analyzer Interface Unit.....	3-29

---

<b>4 Data Files</b>	<b>4-1</b>
---------------------	------------

---

File Header.....	4-1
Data .....	4-2
Diagnostics Header .....	4-4
Status Columns.....	4-6

---

<b>5 Making Flux Measurements with the LI-7700</b>	<b>5-1</b>
--	------------

---

Computing Fluxes.....	5-2
Example Calculation.....	5-5
Full Computation .....	5-5
Simplified Computation .....	5-7
Finding Multipliers.....	5-8
Low Resolution Look-up Tables .....	5-8
Parametric Equations.....	5-11
High Resolution Digital Tables.....	5-14
Zero Flux Validation .....	5-19
References .....	5-20



---

## **6 Theory and Equation Summary** **6-1**

---

Absorption of Infrared Radiation by a Gas .....	6-1
Temperature Dependence of Absorption Line Strength.....	6-2
Line Broadening Mechanisms .....	6-2
Wavelength Modulation Spectroscopy .....	6-4
Compensating for Temperature and Pressure Changes .....	6-5
Compensating for Water Vapor: Equivalent Pressure, $P_e$ .....	6-7
Derivation of Multipliers for Flux Measurements .....	6-9
References.....	6-14

---

## **7 Advanced Operation** **7-1**

---

Calibration .....	7-1
Diagnostics .....	7-3
Laser Temperature Control .....	7-3
Opening the Laser Temperature Control Dialog .....	7-4
Manual Line Lock Example .....	7-5
Re-enabling Automatic Line Lock.....	7-7
Networking .....	7-7
Enabling IPv6 on Windows XP.....	7-7
The LI-7700 Finder Application .....	7-8
Communications Grammar .....	7-14
Introduction .....	7-14
LI-7700 Communications.....	7-14
Element Descriptions .....	7-15
Grammar .....	7-15
Configuration File Grammar.....	7-21
Sending Commands .....	7-24

---

## **8 Appendices** **8-1**

---

Appendix A. Specifications.....	8-1
LI-7700 Open Path CH <sub>4</sub> Analyzer .....	8-1
7700-101 Washer Assembly .....	8-2
LI-7550 Analyzer Interface Unit (optional) .....	8-2
7550-101 Auxiliary Sensor Interface (optional).....	8-2
Power Requirements Summary.....	8-3

Appendix B. Maintenance .....	8-4
Changing the Internal Desiccant Bottle .....	8-4
Changing the Thermocouple.....	8-6
Changing the LI-7700 Fuse .....	8-7
Changing the LI-7550 Fuse .....	8-7
Appendix C. Troubleshooting .....	8-8
Appendix D. Suppliers.....	8-11
Chemical Sources .....	8-11
Calibration Gases .....	8-12
Turck® Cables.....	8-13
Industrial Rated USB Flash Drives.....	8-14
Mounting Hardware .....	8-14

## **Warranty**

## **Index**

# Welcome...

---

...and thank you for your purchase of the LI-7700 Open Path CH<sub>4</sub> Analyzer. We welcome your comments, questions, and suggestions. Feel free to contact us at any time.

LI-COR, Inc.  
4647 Superior Street  
P.O. Box 4425  
Lincoln, Nebraska 68504-0425  
Phone: 402-467-3576 • FAX: 402-467-2819  
Toll-free: 1-800-447-3576 (U.S. & Canada)  
[envsales@licor.com](mailto:envsales@licor.com)  
[www.licor.com](http://www.licor.com)

## About this Manual:

This manual should serve as a guide to understanding the proper operation of the instrument.

**Chapter 1** introduces general information, components, and basic operation.

**Chapters 2 and 3** describe setup and configuration information for the instrument and the LI-7550 Analyzer Interface Unit.

**Chapter 4** describes the data files that the LI-7700 generates.

**Chapter 5** provides special instructions for computing fluxes with data from the LI-7700.

**Chapter 6** describes the theory and physical operation of Wavelength Modulation Spectroscopy and provides the complete derivation of the flux computation algorithm used with the LI-7700.

**Chapter 7** provides advanced operation instructions, calibration information, and communications grammar.

**Chapter 8** includes the appendices, including specifications, maintenance, and troubleshooting instructions, as well as a list of suppliers of equipment that may be useful.

## Laser Safety Information

The Center for Devices and Radiological Health (CDRH) was established in October, 1982, by the U.S. Food and Drug Administration (FDA) to protect the public health in the fields of medical devices and radiological health.

Manufacturers of products subject to performance standards under the Radiation Control for Health and Safety Act of 1968 are required to furnish various reports to the CDRH.

The LI-7700 Open Path CH<sub>4</sub> Analyzer is certified as a Class I Laser product. This means that hazardous laser radiation is not emitted from the instrument. All laser radiation emitted is below the Class 1 Laser limits during any phase of user operation. One laser emits near 1.6 microns and has a peak power rating of 3 milliwatts.

The CDRH implemented regulations for laser products on August 1, 1976 (CDRH radiation performance standard 21, Code of Federal Regulations Chapter 1, Subchapter J). Compliance for products marketed in the United States is mandatory. The label that must be attached to laser products marketed in the United States is located on the side of the lower housing of the LI-7700 Open Path CH<sub>4</sub> Analyzer (Figure 2), indicating compliance with CDRH regulations.



**WARNING:** Use of controls or adjustments or performance of procedures other than those specified herein may result in hazardous radiation exposure.

Although the LI-7700 is a Class 1 device and no hazardous radiation is emitted, refrain from placing highly reflective objects in the optical path and never attempt to place one's head or eyes inside/near the laser path.

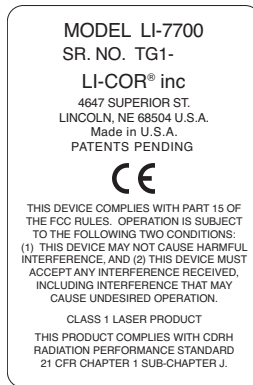

**Figure 1. CDRH regulation compliance label.**

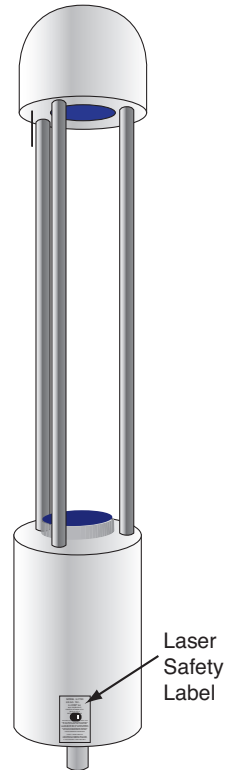

**Figure 2. Location of the CDRH compliance label on the LI-7700 Open Path CH<sub>4</sub> Analyzer.**



# 1 General Information

---

## Overview of the LI-7700

The LI-7700 is a high-speed, high-precision open path methane analyzer designed for use in eddy covariance flux and atmospheric monitoring applications. It uses Wavelength Modulation Spectroscopy (WMS) to make high-speed, precise measurements of methane concentrations at ambient pressure and temperature. It is designed to withstand environmental extremes expected during outdoor deployments. Some features of the LI-7700 include:

- Fast response: data are output at up to 20 Hz bandwidth.
- Low power requirements: 8 W during normal operation.
- Withstands outdoor environmental extremes, including freezing weather and high temperatures (-25 to 50 °C) and rain without damage or calibration shifts.
- Analog input channels to integrate sonic anemometer wind speed (U, V, W) and sonic temperature (T<sub>s</sub>) data with CH<sub>4</sub> data.
- Windows® software for setup and calibration.

Contact LI-COR if you have questions about the suitability of the LI-7700 in your application.

Figure 1-1 shows a schematic of the LI-7700 sensor and the Herriott cell. Except for the desiccant bottle, thermocouple, and fuse, which are accessible externally, there are no user-serviceable parts in the sensor. To ensure that components are not damaged, never attempt to dismantle the sensor.

**Suggested Reference:** When referring to this instruction manual in scientific literature or other publications, we recommend the following citation:

LI-COR, Inc. 2010. LI-7700 Open Path CH<sub>4</sub> Analyzer Instruction Manual. LI-COR, Inc. Lincoln, NE.

## What's What

If you have just taken delivery of your LI-7700, check the packaging list to verify that you received everything that was ordered. The standard LI-7700 will include:

### The LI-7700 Open Path CH<sub>4</sub> Analyzer

- **LI-7700 Open Path CH<sub>4</sub> Analyzer** – This is the sensor. It includes the laser, detector, sampling path, mirrors, heaters, and laser control electronics. The radiation shield is attached to the upper housing prior to shipment.

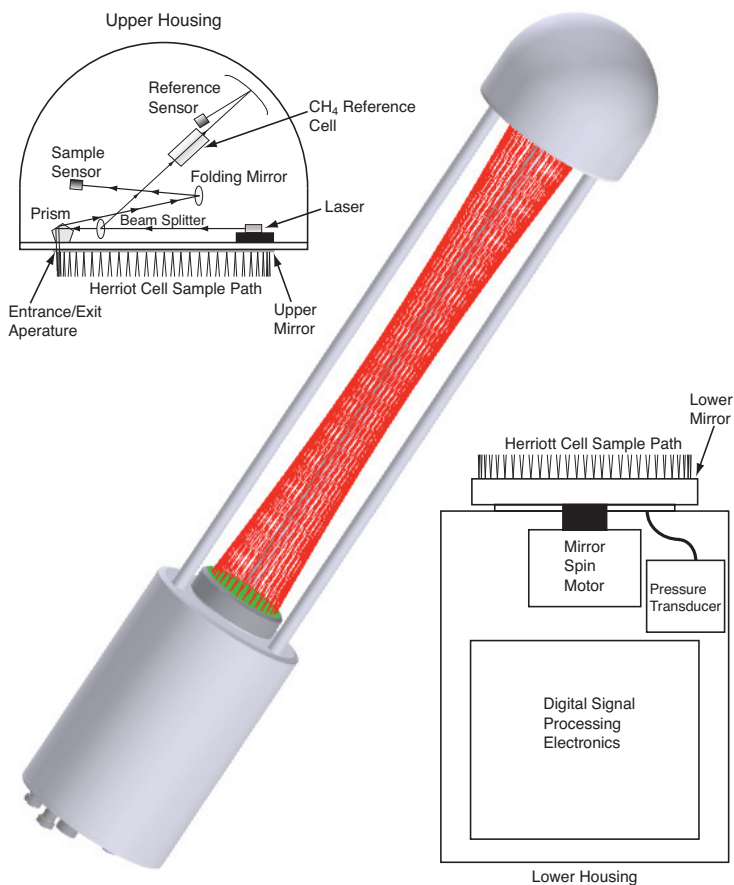

*Figure 1-1. Representations of the LI-7700 upper housing (top left), Herriott cell (center), and lower housing (lower right).*

## Spares Kit and Cables

- **Standard Spares Kit** – This (p/n 9977-019) includes the cables, mounting hardware, and other essential components. Several components listed below are attached to the instrument prior to shipping.

### LI-7700 Spares Kit and Cables

Description	Qty.	LI-COR Part No.
Ethernet Cable, Eurofast (0.3 M) 8-pin female to RJ45	1	392-10107
Ethernet Cable, Eurofast (5 M) 8-pin male to 8-pin male	1	392-10108
Power Cable, Eurofast (5 M), 4-pin female	1	9975-030
5 Amp Fuse	1	438-09800
Desiccant Cap Removal Screw (attached to analyzer)	1	125-09760
Calibration Shroud	1	9977-033
Solar Shield Assembly (attached to analyzer)	1	9977-029
Thermocouple Assembly (attached to analyzer)	1	9977-038
Mounting Post (attached to analyzer)	1	9977-018
Mounting Post Screws (1/4"-20, 5/8" long, attached)	2	140-04320
Washer Reservoir Assembly	1	7700-101
Washer Power Cable	1	392-10211
Spray Nozzle Assembly	1	9977-032

- **Ethernet Data Cables** – There are two Ethernet cables provided: p/n 392-10108 is a 5 m cable terminated on both ends with male Turck® connectors; one end attaches to the LI-7700 Ethernet output, while the end attaches to either the 0.3 m Ethernet adapter cable (p/n 392-10107), or to an LI-7550 Analyzer Interface Unit. When both cables are used, the LI-7700 can be connected to an Ethernet wall socket, Ethernet hub, or the Ethernet port on your computer.
- **Power Cable** (p/n 9975-030) – Used to connect the LI-7700 to a 10.5 to 30 VDC power supply. The power cable has 4 wires: brown and white are tied to a black lead, which connects to the negative (-) power supply terminal; blue and black are tied to a red lead, which connects to the positive power supply terminal (+).

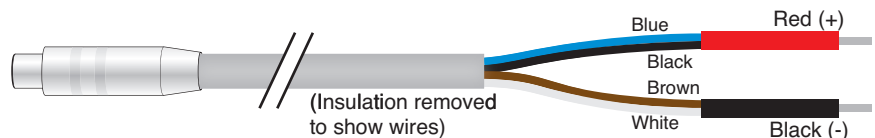



- **Washer Assembly** – The washer assembly includes a reservoir/pump unit, hose, washer nozzle, and mounting hardware.



*Figure 1-2. Washer reservoir for the LI-7700 washer assembly.*

- **Mounting Hardware** – This is the hardware required to mount the LI-7700 on typical platforms. It includes the mounting post and two hex screws that secure the post to the base of the LI-7700 analyzer. The post and screws are affixed to the analyzer prior to shipping.
- **Calibration Shroud** – The calibration shroud is used to isolate the LI-7700 optical path during calibration verification.



*Figure 1-3. LI-7700 calibration shroud.*

- **Computer Software** – The CD includes the LI-7700 configuration/data logging software. The software is compatible with Windows® XP/Vista/7 operating systems.
- **Calibration Certificate** – This documents the performance of your particular instrument when it left the factory. Keep this sheet for future reference.

## 7550-101 Auxiliary Sensor Interface (optional)

The 7550-101 is a weatherproof junction for analog inputs on the LI-7700, LI-7550, and for the analog outputs from the LI-7550. Detailed instructions for using the 7550-101 are provided beginning on page 2-20.



*Figure 1-4. 7550-101 Auxiliary Sensor Interface.*

7550-101 Auxiliary Sensor Interface Spares Kit (optional) p/n 9977-019

Description	Qty.	LI-COR Part No.
U-Bolt, 1/4 by 20	2	184-09842
Hex Nuts	4	163-00138
Quick Connect Plug	10	300-07393
Strain Relief	1	198-01788
Santoprene Tubing	2 ft. (60 cm)	222-08325

## Sonic Anemometer Interface Cables (optional)

As an alternative to the 7550-101, LI-COR can provide cables to carry the analog output from a Gill WindMaster™/Pro or a Campbell® Scientific, Inc. CSAT3 directly to the analog input on the LI-7700 and/or LI-7550. These cables terminate with a Gill or Campbell® bulkhead connector on one end and Turck bulkhead connector(s) on the other (for connecting to the LI-7700 and/or LI-7550).

Description	LI-COR Part No.
Gill WindMaster/Pro to LI-7700	9977-062
Campbell Scientific CSAT3 to LI-7700	9977-063
Gill WindMaster/Pro to LI-7700 and LI-7550 (GHG systems)	9975-034
Campbell Scientific CSAT3 to LI-7700 and LI-7550 (GHG systems)	9975-036

## LI-7550 Analyzer Interface Unit (optional)

The LI-7550 enhances the functionality of the LI-7700 by providing onboard data logging of eddy covariance data sets ( $\text{CH}_4$ , U, V, W,  $T_{ss}$ , and other variables) to a removable USB data storage device and enabling versatile data output options. Detailed instructions for the LI-7550 are provided in Chapter 3.



*Figure 1-5. LI-7550 Analyzer Interface Unit.*

See page 3-2 for a list of components included in the LI-7550 Spares Kit.

## LI-7700 Components and Connections

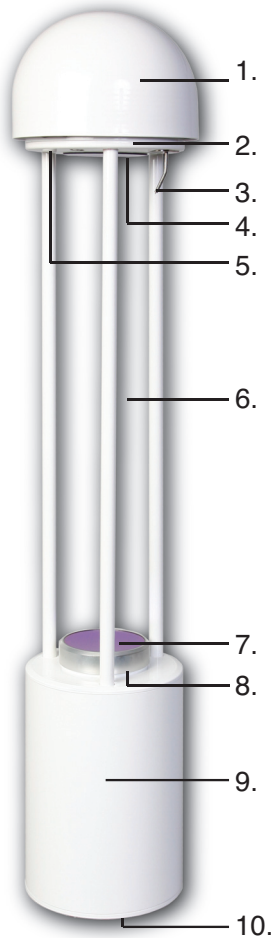

*Figure 1-6. The LI-7700 Open Path CH<sub>4</sub> Analyzer.*

1. **Radiation Shield** – reduces condensation on the upper mirror. It is in place when the instrument is shipped and it should be kept in place during normal operation, especially in high-humidity environments.
2. **Upper Housing** – encloses the laser source, sensor, and laser control electronics (see Figure 1-1).
3. **Fine-wire Thermocouple** – measures the ambient temperature near the optical path. There is a protective sleeve over the thermocouple, which will need to be removed prior to use.
4. **Upper Mirror** – this is the upper mirror in the optical path. It can be configured to remain slightly above ambient temperatures in condensing conditions.
5. **Desiccant Cap** – this seals the desiccant bottle. Only remove the desiccant cap to replace the internal chemical bottle. The desiccant cap removal screw is in place and can be left in place during normal operation.
6. **Sample Volume** – the optical path is 0.5 m in length. The laser makes 60 passes in a Herriott cell pattern for a total path length of 30 m. The laser beam is about 1.5 mm in diameter.
7. **Lower Mirror** – the lower mirror features automated cleaning and temperature controls to prevent condensation on the mirror surface.
8. **Pressure Transducer** – high-speed ambient pressure measurements. The transducer is below the lower mirror.
9. **Lower Housing** – houses the digital signal processing electronics and spin motor (see Figure 1-1).
10. **Connection Panel** – has indicator LEDs, weather-proof cable connections, and an external network reset button (see Figure 1-7).

# 1 General Information

The connection panel on the bottom of the analyzer includes the following components:

1. **Power In** – provide a +10.5 to 30 VDC 3A power supply. The LI-7700 powers on when a suitable power supply is connected. It always starts up with the most recent configuration/settings.
2. **Fuse Housing** – use only a 250V type F 5.0 Amp fuse. An extra fuse is included in the spares kit (p/n 438-09800).
3. **Status LED** – stays solid green when the LI-7700 has finished startup.
4. **Power LED** – stays solid green when a suitable power supply is connected.
5. **Analog Input** – connector for the analog input cable or the 7550-101 auxiliary interface unit (both optional) or a user-supplied interface. It provides 4 analog input channels ( $\pm 5V$ ) for U, V, W, and  $T_s$  data from a sonic anemometer or any other analog sensor, as well as three type E thermocouple connections. This data is output with the LI-7700 data stream.
6. **Washer Power** – supplies power to the external washer unit accessory.
7. **Ethernet Connection** – port for Ethernet communication.
8. **Ethernet LED** – blinks at about 4 Hz when the Ethernet connection is active.
9. **Network Reset** – depress this button to reset the network connection.
10. **Mounting Post** – the mounting post is attached with two  $\frac{1}{4}$ "-20 bolts ( $5/8$ ").

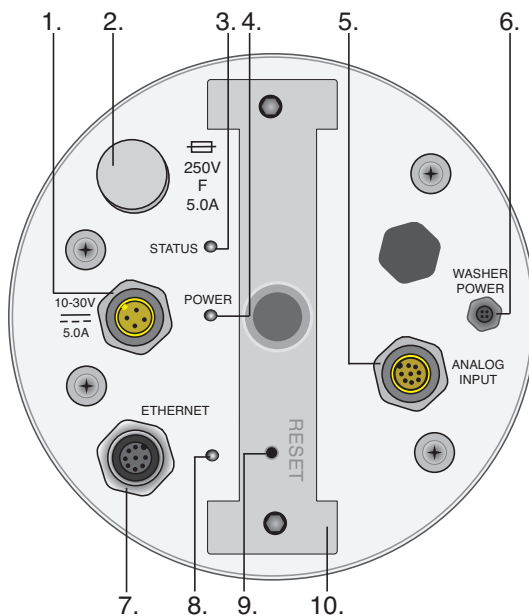

*Figure 1-7. The connection panel on the LI-7700.*

## Basic Setup

This section describes basic setup and operation of the LI-7700.

### 1. Install the LI-7700 Computer Software

The LI-7700 software is compatible with Microsoft® Windows XP/Vista/ and 7 operating systems. Place the included software CD in your computer's CD drive. If the software does not start automatically, navigate to the CD directory on your computer and double click on the **Setup.exe** file on the CD. Follow the on-screen installation instructions.



### 2. Power On

Attach the yellow Turck cable (p/n 9975-030) to the Power connection on the LI-7700 connection panel (Figure 1-8). Align the notch in the cable with the notch in the power-in bulkhead connector and push straight in. Tighten the knurled nut.

Attach the red lead to the positive (+) terminal and the black lead to the

negative (-) terminal of a power supply. This could be a 10.5 to 30 VDC 3 Amp power adapter plugged into a 110 VAC wall outlet or an automotive battery, for example. The LI-7700 powers on immediately after power is supplied. It may take 30 seconds or more to boot up, and the power and status LEDs on the bottom of the LI-7700 will illuminate after instrument completes start-up.



*Figure 1-8. Attach the power cable leads to a suitable power supply to turn on the LI-7700.*



**Caution:** Connecting the power wires with improper polarity will blow the fuse.

### 3. Connect the Ethernet Data Cable

Connect one terminal of the 5 m Ethernet data cable (p/n 392-10108) to the connection labeled Ethernet on the LI-7700 (Figure 1-9).

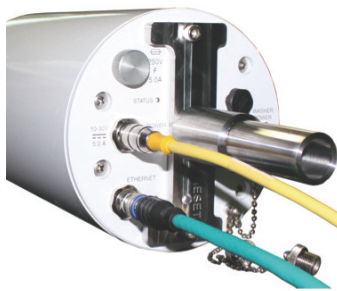

**Figure 1-9.** Attach the 5 m Ethernet data cable as shown.

Attach the other terminal to the 0.3 m Ethernet cable (p/n 392-10107). Plug the RJ45 (Ethernet) terminal into an Ethernet connection on your network, or plug it directly into your computer's Ethernet port (Figure 1-10).

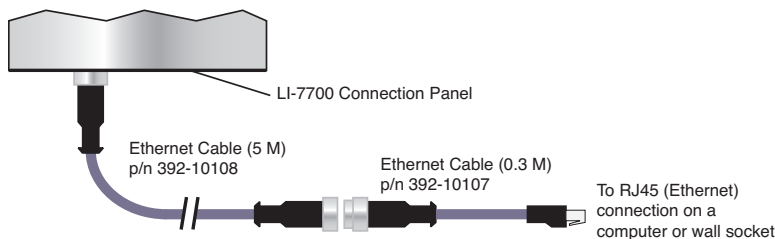
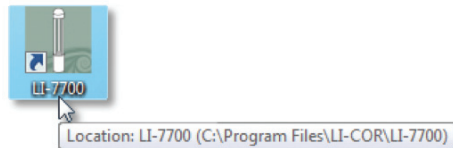

**Figure 1-10.** Attach the 5 m and 0.3 m Ethernet data cable as shown and then attach the RJ45 connector to an Ethernet port on a computer or your computer network.

If you are using the LI-7700 with an LI-7550 Analyzer Interface Unit, rather than attaching the 0.3 m cable, attach the vacant terminal of the 5 m cable to one of the LI-7550 ports labeled “Ethernet.” Attach the second 5 m data cable to the vacant Ethernet terminal on the LI-7550. Join this cable and the 0.3 m Ethernet cable, and connect it to your computer or network as described above. Refer to page 3-7 for additional information on this configuration or if you would like to use the RS-232 serial connection.

## 4. Launch the Software and Connect to an LI-7700

Start the LI-7700 application: either double click the LI-7700 software icon on your computer's desktop or launch the software from your computer's Start menu.



Click on the **Connect** button and a “Connect” dialog box will appear.

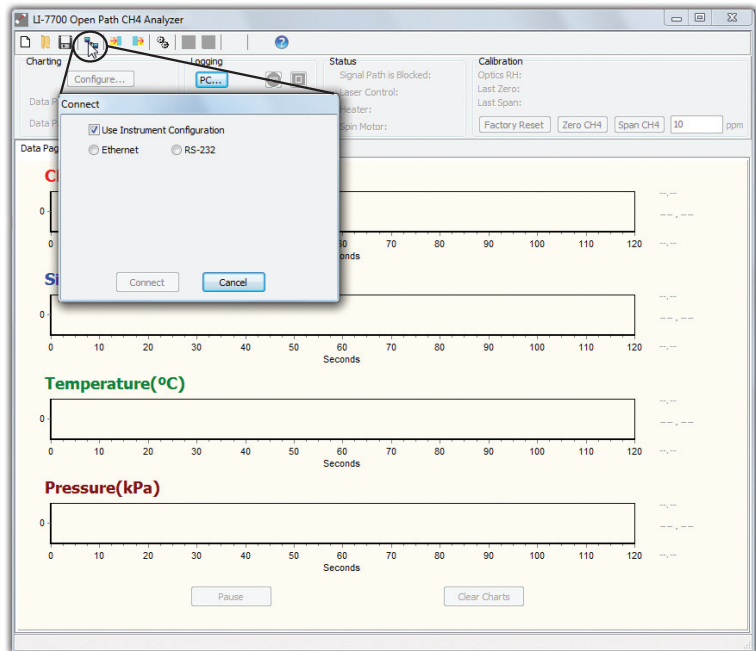

Select the “Ethernet” radio button and then locate your LI-7700 on the “Select Instrument” drop-down menu. Click **Connect**. If the instrument does not appear on the list, wait about 30 seconds for the instrument to finish start-up, then re-launch the software and try to connect again.



## Mirrors - Cleaning and Care

The upper and lower mirrors are extremely scratch resistant, however, the mirror surfaces should be treated the same way you would treat the surface of an expensive lens. In general, refrain from applying a lot of pressure when cleaning a dry mirror. If the mirror is dusty, just wipe it with a soft, clean, moistened cloth. If a sticky substance, such as pollen, has built up on the mirror, a mild soap or a commercial glass cleaner such as Windex® can be used.

There may be the appearance of “spots” on the mirrors. These are normal and are the result of the manufacturing process. The spots are in the visible spectrum and will not affect reflectance near 1.6 microns, which is where the LI-7700 operates.



**Note:** Products such as Rain-X® can be applied to the lower mirror to help the glass shed water.

The washer reservoir uses standard over-the-counter windshield washer fluid. If fouling of the mirror is minor, tap water will work fine. Cleaners that contain methyl alcohol (methanol) and isopropyl alcohol are suitable. Refrain from using cleaners that contain powerful solvents such as acetone. As a general rule, if the cleaner is safe for automotive finishes, it is probably safe to use in the LI-7700 washer reservoir.

The washer should be filled with windshield washer fluid with a temperature rating suitable for the environment in which it will be deployed. For highly sensitive environments, select an environmentally friendly solution.

# 2 Operation

## Introduction to the LI-7700 Interface Software

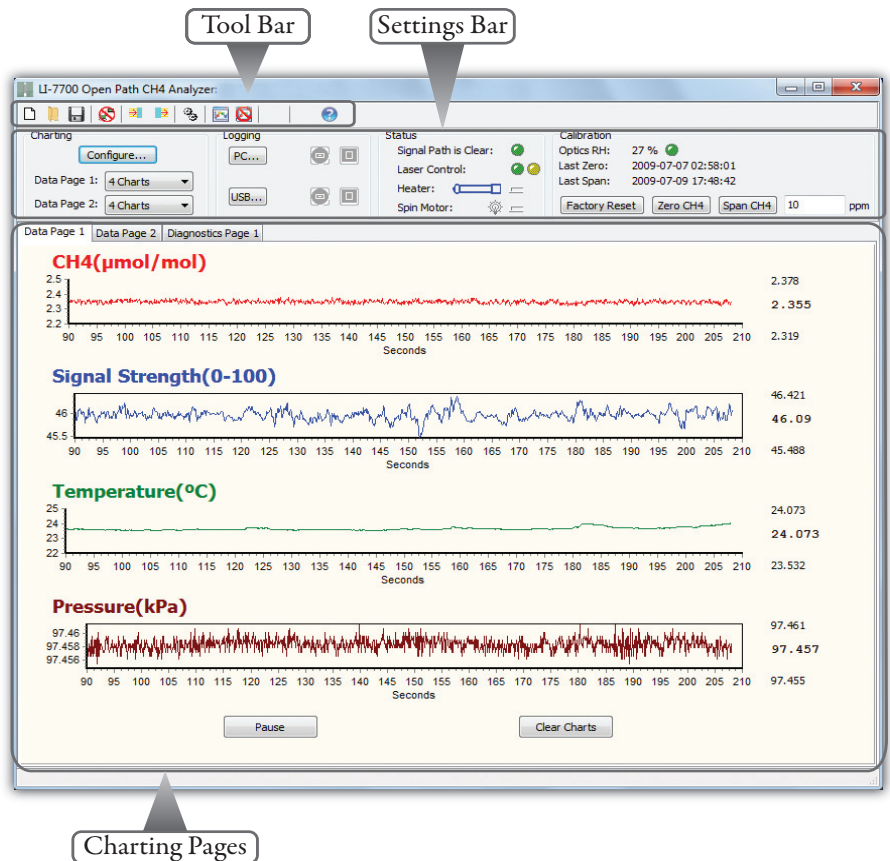

### Main View

After connecting to an LI-7700, the software window should look similar to the image below. The graphs are set to auto-scale the y-axis by default, so do not be alarmed by the appearance of “noisy” signals.



## Tool Bar

The tool bar buttons activate the following options:

Click the **Connect** button to establish communication with an LI-7700. **Disconnect** buttons (Ethernet:  or serial: ) will be visible when an instrument is connected. Click the button to disconnect.

**Manual Controls** are the basic configuration options for the LI-7700, including settings for mirror heaters, mirror cleaning, instrument name and address, instrument time settings, and data output rate.

The **Help** button opens a menu with “About” and the built in “Help” file. This provides access to a factory setup application as well.



The file buttons are used to **Create, Open,** or **Save** a configuration file.

LI-7700 and LI-7550 inputs are configured with the **Inputs** button (left). **Outputs** (right) are available when an LI-7550 Analyzer Interface Unit is used (see Chapter 3).

**Waveforms** can be turned on (left button) or off (right button). The waveform is viewable in the charting pages.

## Settings Bar

Four groups of settings and operation parameters are displayed in this portion of the main window:

The Charting frame provides access to graph settings. Click on **Configure...** to change the charting settings. Select the number of charts displayed on each tab (1 to 4) using the drop-down menu.

The Status frame indicates the status of operating parameters.  
**Signal Path is Clear:** green indicates normal operation; red indicates the path is blocked.  
**Laser Control:** left indicator is green during normal operation and red if the laser temperature or block temperature are outside the setting or that the reference signal unlocked (see page 7-3). The yellow/blue indicator (right) shows the operating temperature range setting (2-8).  
**Heater:** indicates status of mirror heaters. Red is on, clear is off.  
**Spin Motor:** indicates status and setting for the mirror cleaner controls.

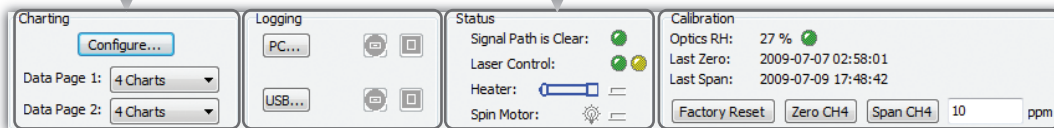

The Logging frame indicates whether an LI-7550 is present and provides access to PC and USB data logging configurations. Click **PC...** to configure logging on a network or computer. Click **USB...** to configure logging to a removable USB storage device (LI-7550 Analyzer Interface Unit required). The Start Button (⏪) becomes active (⏩) after logging is configured. The Stop Button (⏸) becomes active (⏹) after logging has started.

The Calibration frame provides the interface buttons for setting the instrument zero and span. The **Optics RH:** indicator is green during normal operation and red if the desiccant needs to be replaced. The procedure for setting the **zero** and **span** is described on page 7-1. Clicking the **Factory Reset** button will reset the instrument to the factory original zero and span settings.

## Charting Pages

Three pages (tabs) display the live data stream. Configure the data pages with the **Configure** button in the Charting frame described below. The Diagnostics page displays the instrument waveform, which is turned on or off with the “Waveform” button described above.

## About the LI-7700 Dialog Boxes

The Manual Controls, Charting, Auxiliary Inputs, Outputs, PC Logging, and USB Logging dialogs include **OK**, **Cancel**, and **Apply** buttons. In these dialogs, click **OK** to implement changes and close the dialog, **Cancel** to close the dialog without implementing changes, or **Apply** to implement changes and keep the dialog open.

## Charting

Two charting pages are visible, and each of these pages can display up to four charts. The charting pages are the two tabs called “Data Page 1” and “Data Page 2” in the main view. To configure the charts, select the tab with the charts you’d like to configure, then click the **Configure** button in the Charting frame of the main view.

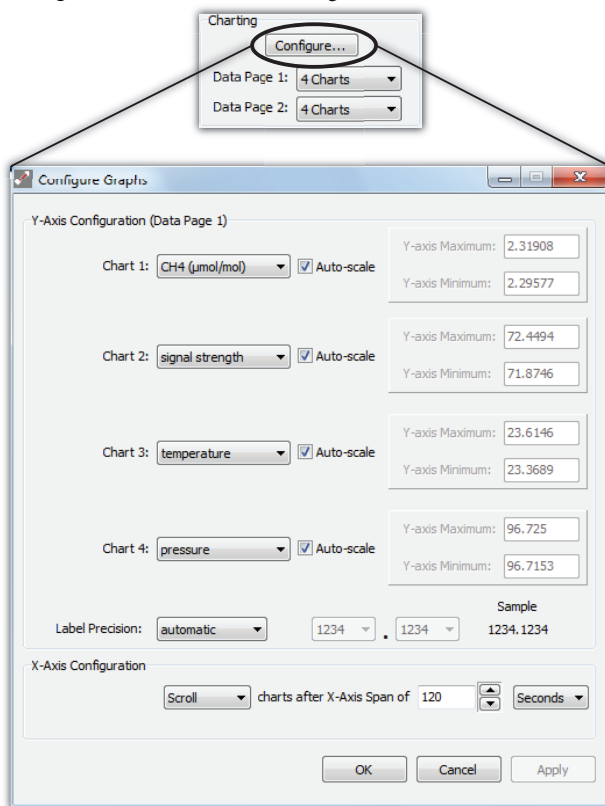

The Configure Graphs dialog box allows you to select which variables are displayed, automatic/manual graph scaling, label precision, scroll settings, and X-axis configuration. Click **Apply** to implement any changes.

### About charting

In the Configure Graphs dialog you can turn automatic scaling “on” or “off” with the **Auto-scale** check box. When automatic scaling is on, the software retains a record of the maximum and minimum values encountered and scales the graph accordingly. If you click the **Clear Charts** button in the main window the chart scaling will reset.

Automatic scaling can be turned on or off simply by **double clicking** on a graph in the main view. When automatic scaling is on, the graph will have a frame. When automatic scaling is off, the frame will be open, as shown below.

Automatic scaling is “Off”, indicated by the open frame.

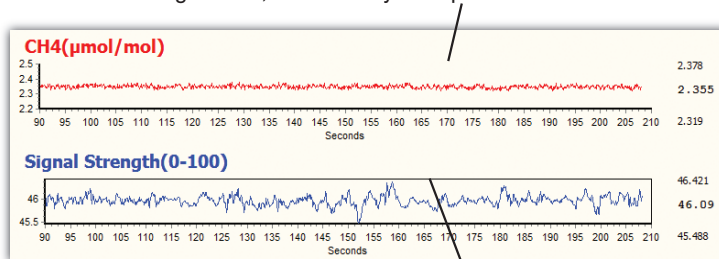

Automatic scaling is “On”, indicated by the closed frame.

## Configuring the LI-7700

The following sections describe PC/Network data logging, operating temperature range settings, mirror cleaner settings, and mirror heater settings. When the LI-7700 settings are changed, they are implemented to whichever LI-7700 is connected to the interface. After changing the configuration, you could unplug the instrument and deploy it in the field. When it is connected to a power supply it will operate with the previously defined settings. Configurations can be saved and implemented from a file too (see page 2-19).

### PC/Network Data Logging (Ethernet Output)

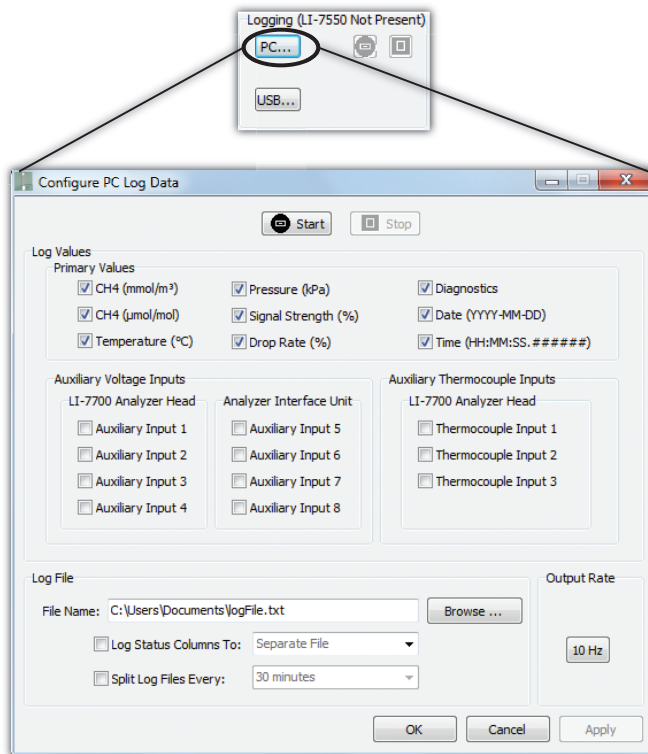

1. Establish communication with your LI-7700. Click on the **PC...** button in the Logging frame of the main view.



2. Select the variables that you'd like to log. Click **Apply**.



**Note:** Auxiliary Inputs 5 through 8 can only be logged when an LI-7550 Analyzer Interface Unit is used.

3. Choose a directory that the files will be written to, choose whether to log the “Status” record, and whether it will be part of the data file or a separate log file. Choose how often to split the log files (from 15 minutes to 24 hours). Click **Apply**.
4. Click the button under “Output Rate” to open the Manual Controls window (see page 2-9), where you can change the output rate. Click **Apply** in the Manual Controls window.
5. Click “Apply” or “OK” in the Configure PC Data Logging Window.
6. The **Start** button will be available (no longer grayed out). You can click **Start** () in this window to begin logging immediately or click **OK** to return to the main view where a second **Start** button () will be active.

When actively logging, the control settings will be grayed out, a green indicator will appear in the main view, and the **Stop** button will become active. If you are logging data to a PC, be sure to disable sleep mode so the computer does not enter “stand-by.”

### ***Logging Status Columns***

Status data (described on page 4-6) can be logged to the data file, logged to a separate file, or not logged. To log status data, check the “Log Status Columns To:” check box, then select “Separate File” or “Log File.” Status data are logged at 2 Hz. If you select “Log File”, the status data will be interspersed with the data record.

### ***Splitting Files***

To help limit the size of individual files, log files can be split on a periodic basis. The method of splitting is based on the instrument clock, rather than on elapsed time. As such, the file will split when the instrument time crosses a user-specified interval. For example, if the application is set to split the log file every 15 minutes and the logging session starts at 11:25, the first split will occur at 11:30. The second split will occur at 11:45, and so on.



### Operating Temperature Range

Two operating temperature ranges are available: -25 °C to 25 °C (cool) and 0 °C to 50 °C (warm). Select the temperature range setting that reflects the expected temperatures in the environment where you will deploy the LI-7700. If the wrong temperature setting is selected, the instrument may be unable to maintain the required temperature in the internal controls, and thus lose line lock (and it will not record methane data).

The current setting is indicated by either a blue (cool) or yellow (warm) “light” indicator in the main window.

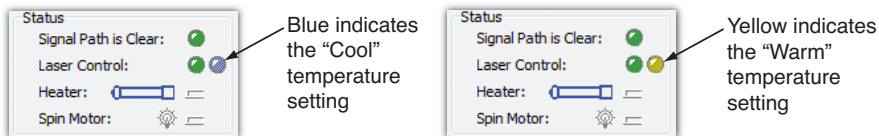

To change the setting, click on the yellow or blue indicator “light.” This will open the dialog shown below, in which you can change the setting.

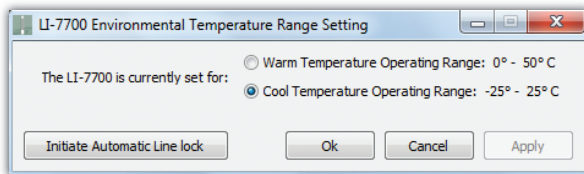

After changing the temperature range setting, it may take up to 5 or 10 minutes for the block temperature to adjust before the instrument returns to normal operation. Look at the Diagnostics Page 1 tab and observe the Block Temperature setting. The “Actual” and “Set” temperatures should be within about 0.5 °C after the temperature adjusts.

If the instrument is unable to achieve line lock once the new operating temperature range is established, click the “Initiate Automatic Line lock” button. This will command the instrument to re-try the automatic line lock routine.



**Important:** After changing the operating temperature range, be sure to re-zero and span the analyzer using high-quality (1% or better methane in air) calibration gases.

## Manual Controls

The Manual Controls dialog provides access to controls for the following settings: mirror cleaner settings (page 2-10), mirror temperature controls (page 2-10), instrument time and date (page 2-16), time zone, IP address, and output rate (Hz).

To change the settings:

1. Click on the **Manual Controls** button (  ) to open the Manual Controls dialog box.
2. Change the settings as desired and then click **Apply** or **OK**.
3. Any changes will be implemented immediately to the connected LI-7700. These settings will be saved in the LI-7700 or they can be saved as a configuration file (see page 2-19).

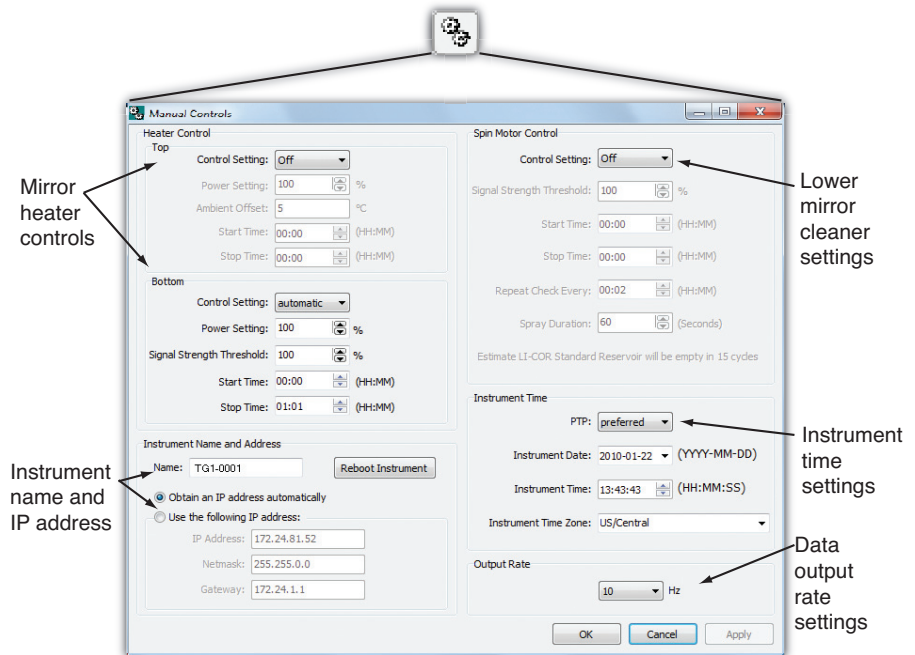

Detailed descriptions of these settings are provided in the following pages.

## Configuring Mirror Heater Controls

Mirror heaters serve to keep the mirrors free of condensation and frost. They are configured in the Manual Controls window in the heater control frame. See page 2-11 for information on selecting settings and page 8-3 to learn about power requirements for the heaters.

1. Heater **Control Settings** can be **On**, **Off**, or **Automatic**. Setting to **On** enables power and ambient offsets for the upper mirror and power settings for the lower mirror. The **Automatic** setting enables all possible controls.
2. **Power Setting** specifies how much power is delivered to the mirrors. In environments with light condensation, power settings of 10% or less should be adequate. Settings near 100% should be reserved for circumstances in which severe ice buildup is expected.
3. **Ambient Offset** specifies how far above the ambient temperature (as measured by the optical path thermocouple) the mirror is heated to. This setting applies only to the upper mirror.
4. The **Signal Strength Threshold** (RSSI) for the lower mirror heater. It is enabled when the Control Setting is set to **Automatic**.
5. **Start Time** and **Stop Time** specify when the mirror heaters are on. These are available only when the Control Settings are **Automatic**.

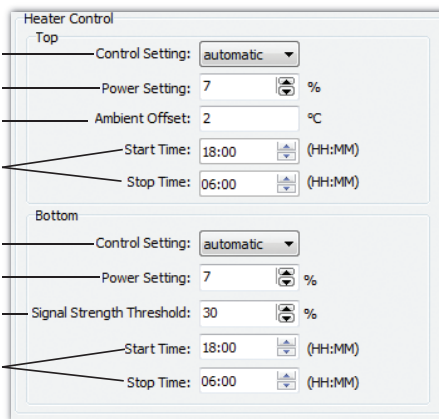

With the settings shown above, the LI-7700 will deliver 7% of the maximum possible heater power, as needed to keep the mirror 2 °C above ambient temperatures between 6:00 pm (18:00) and 6:00 am (06:00) to the upper mirror. The lower mirror will be heated with 7% of maximum possible power, only if the signal strength is below 30%, between 6:00 pm (18:00) and 6:00 am (06:00).

To save power, set the mirror heaters to operate when condensation is likely. Set them to heat as little as is needed to keep the mirrors free of condensation. Mirror heater power consumption is linear with the setting. Thus, a setting of 100% requires about 8 W, whereas a setting of 10% requires about 0.8 W (also see page 8-3).

### ***Determining Mirror Heater Settings***

The mirror heaters serve to remove/prevent the buildup of condensation on the mirrors. Determining what mirror settings are best for your application/environment is best done with some experimentation. The following guidelines should serve as a starting point:

1. Make an estimate of when condensing conditions begin and end, and set the mirror heater start and stop times accordingly. Refer to a weather forecast or recent meteorological records. It is easier to prevent condensation than it is to remove condensation, so set the heaters to preempt the formation of dew.
2. Estimate how far below the dew point temperature the actual temperature will fall. Use this to determine power settings and upper mirror ambient offset. If the predicted temperature is only a little below the dew point, a power settings of <10% with an ambient offset (upper mirror) of 1 °C may work fine. Power settings close to 100% should be reserved for extreme conditions where ice buildup is expected.
3. Check your data. If you find data loss or reduced RSSI readings during condensing conditions, it will be worthwhile to boost the power settings or lengthen the time window during those periods.

### Configuring the Spin Motor Control

There are two components involved with the self-cleaning mirror – the mirror spin motor, which is in the lower housing (see page 1-7), and the washer assembly (see page 1-4). During the cleaning cycle, the pump and spin motor run simultaneously for the first part of the duration, and the spin motor alone runs for the last 10 seconds of the duration. This provides two benefits: any drops that fall from the nozzle will be cleared by the spinning mirror, and it allows the mirror to spin without using washer fluid. Spin Motor Controls are in the Manual Controls window.



**Important:** The mirror washer unit settings are designed to provide a great deal of flexibility. Certain settings, however, are unsuitable for certain environments. The use of improper settings may result in missed data, excessive power consumption, or rapid depletion of the washer fluid.

Spin Motor Controls include:

1. The **Control Setting** can be **On**, **Off**, or **Automatic**. Change the setting to **Automatic** to enable the remaining controls.
2. **Signal Strength Threshold** refers to a threshold (Received Signal Strength Indicator, or RSSI). If the laser signal strength falls below this threshold, the mirror spin motor and washer pump will activate according to the other settings.
3. **Start Time** and **Stop Time** specify the period of the day in which the mirror cleaner can activate. Set both to 00:00 to allow mirror cleaning for 24 hours a day.
4. **Repeat Check Every** sets the interval at which the instrument re-checks the RSSI value. If the RSSI value is below the Signal Strength Threshold (#2), then it will repeat the cleaning cycle according to the remaining parameters.
5. **Spray Duration:** can be set from 0 to 110 seconds. A setting of 0 will result in no spray, but the mirror will still spin for 10 seconds if the RSSI is below the signal strength threshold.

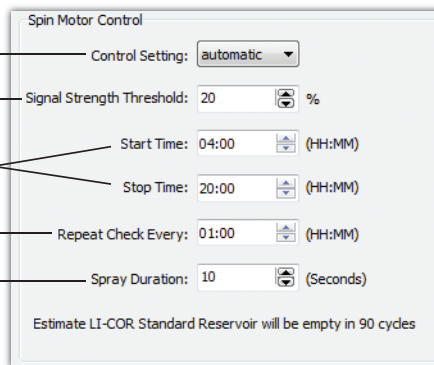

With the settings shown above, if the signal strength is below 20%, the LI-7700 will initiate a 20 second cleaning cycle starting at 4:00 am (04:00). If the first cleaning cycle fails to raise the signal strength to above 20%, it will repeat every hour until 8:00 pm (20:00) or until the signal strength is above 20%.

The figure below depicts how the LI-7700 uses the Spin Motor Control settings:

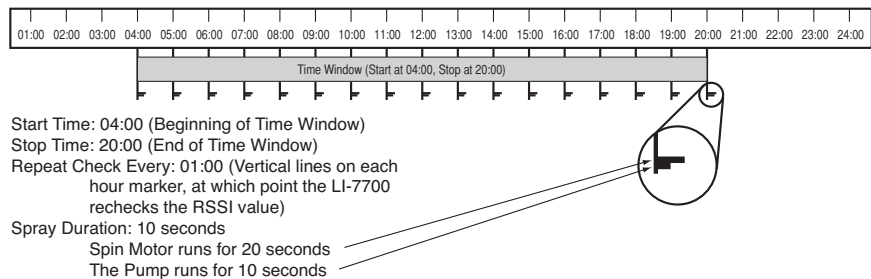

**Figure 2-1. Depiction of mirror heater control settings.** The gray bar (“Time Window...”) shows the “Start Time” and “Stop Time”. The “Repeat Check Every:” interval is indicated by the vertical hash marks across the gray bar. Spray duration is indicated in the inset.

If the RSSI value is below the “Signal Strength Threshold”, a cleaning cycle will be initiated according to the “Repeat Check Every” setting. The pump always runs for 10 seconds less than the spin motor. Set the “Spray Duration” to 0 seconds to spin the mirror for 10 seconds without spraying any fluid.



**Important:** The use of a low signal strength threshold (e.g. ~10%) may result in “noisier” data as the signal strength gets lower. Check your data to observe this, and choose a setting that is within the noise tolerance that you prefer. Conversely, a high signal strength threshold (e.g., 80%) will cause the washer fluid to be used more quickly. Also, the spinning mirror will cause perturbations in the pressure measurement. Data collected while the spin motor is active should not be used.



**Note:** The 7700-101 is equipped with an inlet connection that can be used to attach a secondary washer reservoir. In environments where the washer fluid is used quickly, a secondary washer reservoir can be used to refill the 7700-101 reservoir. This will require a pump or siphon to transfer fluid from the secondary reservoir to the 7700-101 reservoir.

### ***Determining Mirror Cleaner Settings***

Below, we discuss some relevant considerations and recommend some starting points for determining which settings are best for your application/environment. It is best to experiment a little to find out what is best for your environment/application.

Here are some examples that can serve as starting places:

**Scenario 1:** If you expect fouling of the mirrors to result from slow dust accumulation (as opposed to bird droppings, rain, snow, water droplets, or blowing sand) start with the following settings:

Signal Strength Setting:	10%
Start Time:	00:00
Stop Time:	00:00
Repeat Check Every:	01:00
Spray Duration:	20 Sec

The LI-7700 will check the signal strength (RSSI) every hour. If the RSSI is below 10%, the analyzer will initiate a 30 second cleaning cycle, which is 20 seconds of spray + spin then 10 seconds of spin only. **Disadvantages:** If the mirror becomes very dirty and cannot be cleaned, the washer fluid reservoir will become empty after 45 cleaning cycles. If the RSSI is low because of rain, the cleaning cycle will activate. Therefore, these settings are not recommended in environments where frequent rain is expected.

**Scenario 2:** If you expect fouling to result from frequent ephemeral interruptions, such as snowflakes, bugs, or water droplets (not rain), but you do not expect much dust accumulation or rain showers, start with the following settings:

Signal Strength Setting:	10%
Start Time:	00:00
Stop Time:	00:00
Repeat Check Every:	00:01
Spray Duration:	0 Sec

The LI-7700 will check the signal strength (RSSI) every minute. If snowflakes or bugs drive the RSSI down, the LI-7700 will spin the mirror for 10 seconds. No washer fluid will be pumped. **Disadvantages:** if bird droppings foul the mirror, merely spinning the mirror probably will not clear it, and the mirror will spin for 10 seconds every minute until the debris is removed. Falling rain could also cause the mirror to spin for 10 seconds every minute. Therefore, refrain from using these settings in regions that experience frequent rain.

**Scenario 3:** If you expect fouling to result from bird droppings or slow dust accumulation, start with the following settings:

Signal Strength Setting:	10%
Start Time:	01:00
Stop Time:	01:30
Repeat Check Every:	00:05
Spray Duration:	10 Sec

The LI-7700 will check the signal strength (RSSI) every 5 minutes between 1:00 and 1:30 a.m. If it is below 10%, the cleaning cycle will be 10 seconds of spray + spin, then 10 seconds of spin only. It will carry out this process up to 6 times between 01:00 and 01:30.

**Disadvantages:** When the mirror becomes fouled (enough to drive the RSSI below 10%), data could be lost until the mirror is cleaned, which will begin at 1:00 am.

### ***Instrument Name and Address***

To rename your LI-7700, simply type the new name of your LI-7700 into the name field and click “OK” or “Apply.” Then reboot the instrument.

The screenshot shows a dialog box titled "Instrument Name and Address". It has a "Name:" label followed by a text input field containing "TG1-0001". To the right of this field is a "Reboot Instrument" button. Below the name field are two radio button options: "Obtain an IP address automatically" (which is selected) and "Use the following IP address:". Under the second option, there are three stacked text input fields: "IP Address:" with "172.24.81.52", "Netmask:" with "255.255.0.0", and "Gateway:" with "172.24.1.1".

The communication interface to the analyzer head is by Ethernet. More specifically, it is by the IPv6 Ethernet Protocol. As such, it is generally not necessary to configure a static IP address for the instrument if the instrument name is known. The instrument broadcasts its name onto the network, and the LI-7700 Windows Application looks for that broadcast and the populates the “Connect” dialog box accordingly.



### Setting the Time

The LI-7700 is shipped with the time set at the factory. To set your local time:

1. Connect to the LI-7700.
2. Open the **Manual Controls** dialog box.
3. Set the **PTP:** field to “automatic.”
4. Select the desired time zone.
5. Click **Apply** or **OK**.

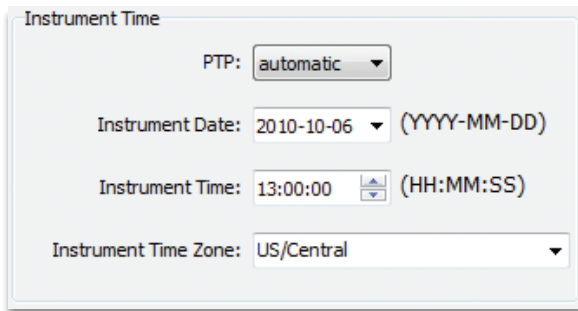

The screenshot shows a dialog box titled "Instrument Time". It contains four fields: "PTP:" with a dropdown menu set to "automatic"; "Instrument Date:" with a dropdown menu set to "2010-10-06" and a label "(YYYY-MM-DD)"; "Instrument Time:" with a text input set to "13:00:00" and a label "(HH:MM:SS)"; and "Instrument Time Zone:" with a dropdown menu set to "US/Central".

You may also adjust the time if

desired, but these adjustments apply to the Unix time stamp as well. Therefore, be sure that the instrument time and date match your local time and date and that you have set the correct time zone.

The time stamp in each file header shows the instrument time and time zone. The time stamp associated with each data record will always include Unix time, but you can choose to output the instrument time and date as well. Unix time is in two fields: seconds and nanoseconds. Conventional time includes the date and time resolved to seconds. The nanoseconds field can be used to resolve sub-second time stamps.

### About LI-7700 Time Keeping

Three aspects of time keeping in the LI-7700 are described here – the basis for the actual time (Unix, aka POSIX), the protocol for determining the actual time (Precision Time Protocol), and user-settable time zone and time.

The LI-7700 is a network-based instrument and it is possible for multiple users to log data from a single instrument over multiple TCP/IP connections. Consequently, the instrument uses Coordinated Universal Time (UTC) for its onboard timekeeping tasks. As such, the default time stamp is UTC based, but local time can be set as well.

The LI-7700 internal clock uses Unix time as a standard. Simply put, this is seconds elapsed since the Unix Epoch of 00:00 Coordinated Universal Time (UTC) Jan. 1, 1970 (or 1970-01-01T00:00:00Z ISO 8601). For example, the time stamp 1262884605 translates to 01/07/2010 at 05:16:45 UTC. The date and time are converted into a conventional display format (YYYY-MM-DD; HH:MM:SS), and adjusted based on the time zone settings that you select.

The LI-7700 uses the Precision Time Protocol (PTP) time keeping system. PTP is a high precision time synchronization protocol for networked measurement and control systems. Devices controlled with PTP can maintain accuracy in the sub-microsecond range with a sufficiently accurate master clock. PTP is defined in the IEEE 1588-2002 and 1588-2008 standards, officially entitled “Standards for Precision Clock Synchronization Protocol for Networked Measurement and Control Systems.” A detailed summary of IEEE-1588 is available at [www.ieee1588.com](http://www.ieee1588.com). Full documentation is available for purchase from the Institute of Electrical and Electronics Engineers (IEEE) at [www.ieee.org](http://www.ieee.org).

The basic principle behind the PTP is that the best time keeping can be accomplished with multiple networked devices by synchronizing all the device clocks to the most precise clock on the network. Each clock on the network has a rating that indicates its relative accuracy. The IEEE 1588 protocol specifies the use of a Best Master Clock algorithm to determine which clock on the network is the most accurate. On a network, the most accurate clock becomes the master clock and all other clocks sync to the master clock.

The software implementation of PTP in the LI-7700, which uses the instrument clock, provides accuracy in the 10 microsecond range. Implementation of PTP is most important when the LI-7700 is used in combination with the LI-7550 Analyzer Interface Unit or other network-based sensors.

Three time-keeping settings are available in the Manual Controls dialog. They are:

**Automatic:** The LI-7700 searches the network and syncs to the most accurate clock using the Best Master Clock algorithm. The LI-7700 should use this setting in most circumstances.

**Preferred:** The LI-7700 uses its own internal clock unless it finds a better clock on the network. The LI-7550 should use this setting in most circumstances.

**Slave:** The LI-7700 syncs to another clock. It will search the network and synchronize to the best clock.

### Output Rate

The output rate setting determines the signal averaging done by the digital filter. To avoid aliasing (only a concern for co-spectra, not for fluxes), the LI-7700 output rate should be set at a frequency greater than or equal to 2 times the desired bandwidth, also referred to as the Nyquist frequency (e.g., for a bandwidth of 20 Hz, set the output rate to 40 Hz). This is set in the Manual Controls window.

Bandwidth is the frequency at which the indicated amplitude is 0.707 of the real amplitude.

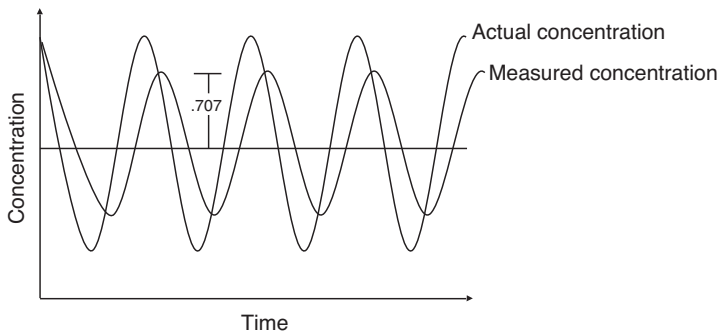

**Figure 2-2. Bandwidth = 1/ oscillation period.**

Bandwidth is useful for characterizing real-world behavior in which there are fluctuating gas concentrations. Given a sinusoidal oscillation of concentration, the instrument's ability to measure the full oscillation amplitude diminishes as the oscillation frequency increases.

## Configuration Files

### *Creating an Instrument Configuration File*

The following procedure describes how to create a new instrument configuration file. See page 7-21 for more information on configuration files.

1. Launch the LI-7700 Windows® software.
2. Be sure the LI-7700 software is not connected to an LI-7700. If needed, click the **Disconnect** button. Optional: click the **New Instrument Configuration** button to restore default settings.
3. Click on the **Manual Controls** button. Set the controls as desired. Click **OK** or **Apply** then **OK** to set the new configuration. Repeat this for the Auxiliary Inputs and LI-7550 Outputs if desired.
4. Click the **Save** button . A **Save As** dialog box will open. You can select a directory anywhere on your computer or network. The file will have a “.l77” extension.

### *Implementing a Configuration File*

The following procedure describes how to implement a configuration file.

1. Be sure the LI-7700 is powered “on” and connected to your computer or network with the Ethernet connection.
2. Launch the LI-7700 software and connect with the LI-7700.
3. Click on the **Open** button . The “Open” dialog box will appear. Navigate to the directory that has the “.l77” configuration file.
4. Select the file and click **Open**.
5. A warning dialog will appear. Click **Yes** to implement the configuration file. The LI-7700 can now be disconnected from your computer and the power supply. It will use this configuration when it is started the next time.



**Note:** when you connect to an LI-7700, at the top of the “Connect” dialog box, there is a “Use Instrument Configuration” check box. Be sure that this is checked in order to prevent overwriting the current LI-7700 configuration.

## LI-7700 Analog Inputs

The LI-7700 and the LI-7550 each provide 4 analog input channels. These can be used with either the optional 7550-101 Auxiliary Sensor Interface, the Analog Input/Output Cable (p/n 392-10109), or sonic anemometer analog input cables (see page 1-5). The 7550-101 is a weatherproof terminal strip that provides sealed electrical connections. The Analog Input/Output Cable terminates with bare leads on one end and a Turck connection on the other. It is included with the LI-7550 Analyzer Interface Unit and available as an optional accessory.

The 7550-101 Auxiliary Sensor Interface and the Analog Input/Output Cable can be used in any of the three configurations shown in Figure 2-3, but *the three type E thermocouple connections (Option 1) are only available through the 7550-101 and can only be used with the LI-7700 analog inputs.*

The 7550-101 Auxiliary Sensor Interface and the Analog Input/Output Cable can be used to connect analog data sources to the LI-7700 (Option 1) or the LI-7550 Analyzer Interface Unit (Option 2). They can also be configured to distribute the 6 analog outputs of the LI-7550 (Option 3).

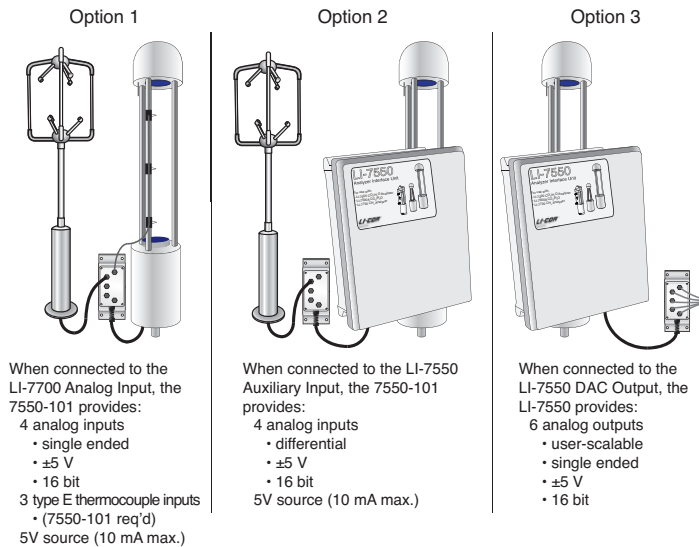

**Figure 2-3. The 7550-101 can function as a weather-proof terminal strip for the LI-7700 Analog Input (Option 1), the LI-7550 Auxiliary Input (Option 2), or the LI-7550 DAC Output (Option 3).**

Here we describe how to use the 7550-101 or the Analog Input/Output Cable as shown in Option 1 above. Options 2 and 3 are described beginning on page 3-16. Note that Options 1, 2, and 3 can be used together in any combination.

### Auxiliary Sensor Interface Terminals (Option 1)

Loosen the four Philips head screws in each corner of the Auxiliary Interface Box module and remove the top cover. The interior of the interface is shown in Figure 2-4.

There is a small jumper located at the LK1 label; when using the 7550-101 with the LI-7700 (Option 1), position the jumper over the 2 pins nearest the LI-7700 label (the lower two pins in Figure 2-4).

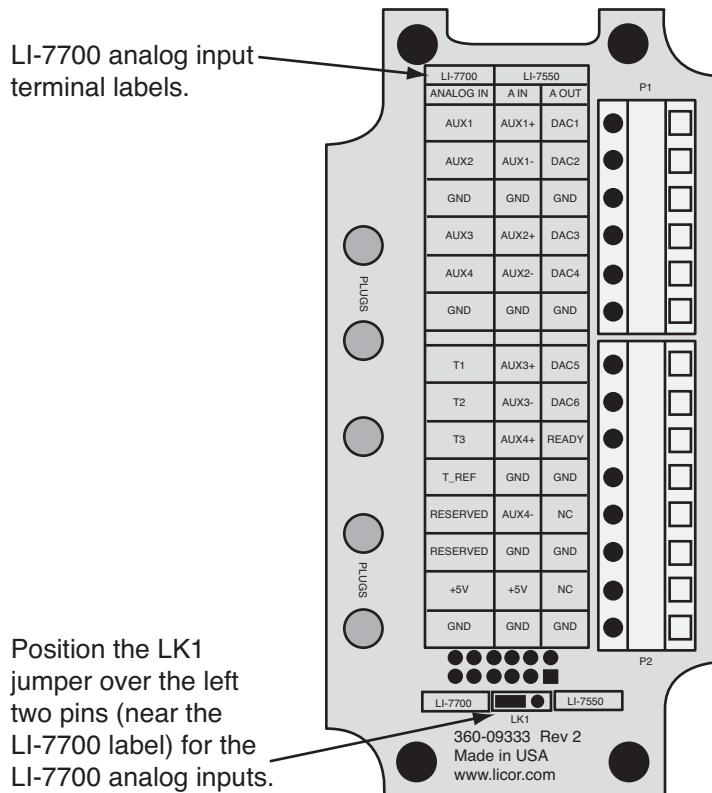

*Figure 2-4. Schematic diagram of interior of Auxiliary Sensor Interface.*

There are two terminal strips, with connections as follow:

### When Used for Analog Inputs (LI-7700)

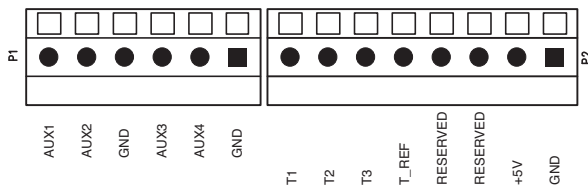

**Figure 2-5. Terminal connections for analog inputs (Option 1).**

The terminal positions are numbered and configured as follows, reading from left to right:

**Table 2-1. Terminal assignments for the 7550-101 and wire colors for the Analog Input/Output cable when using the LI-7700 analog inputs (Option 1).**

Option 1				
7550-101 Auxiliary Sensor Interface		Description	Analog In/Out Cable (p/n 392-10109)	
Terminal	Input		Wire Color	Pin
1	AUX1	Auxiliary Input 1 Signal	White	Pin 1
2	AUX2	Auxiliary Input 2 Signal	Brown	Pin 2
3	GND	Ground	Tan	Pin 10
4	AUX3	Auxiliary Input 3 Signal	Green	Pin 3
5	AUX4	Auxiliary Input 4 Signal	Yellow	Pin 4
6	GND	Ground	Tan	Pin 10
7	T1	Thermocouple 1 Signal <sup>1</sup>	Gray	Pin 5
8	T2	Thermocouple 2 Signal <sup>1</sup>	Pink	Pin 6
9	T3	Thermocouple 3 Signal <sup>1</sup>	Blue	Pin 7
10	T_REF	Thermocouple Reference <sup>1</sup>	Black	Pin 11
11	Reserved	Thermistor Input	Red	Pin 8
12	Reserved	Thermistor Reference	Violet	Pin 12
13	+5V	+5V Supply (10 mA max.)	Orange	Pin 9
14	GND	Ground	Tan	Pin 10

<sup>1</sup> Using the thermocouple channels (T1 to T3) requires measurement of the reference junction temperature. This is accomplished with an internal thermistor in the 7550-101.

## Connecting Sensors to the Auxiliary Sensor Interface

There are 5 “gland” type plugs on the Auxiliary Sensor Interface top cover that secure and seal the wires that are connected to terminals inside the box. To attach your sensor(s) to the Auxiliary Sensor Interface, follow these steps:

1. Remove the #1 Philips screws from each of the four corners of the Auxiliary Sensor Interface and remove the top cover.
2. Remove the cap from a gland plug by turning the cap counterclockwise.
3. Pass the wires through the top of the plug cap, rubber grommet, and then through the gland plug.
4. Use a small flathead screwdriver to loosen the appropriate screw terminals and insert the wire leads into the terminals. Tighten the screw terminals to secure the wires. Make a note of which plug the wires are passing through and which terminals the wires are connected to. This will be needed later when you configure the sensor coefficients in the software.

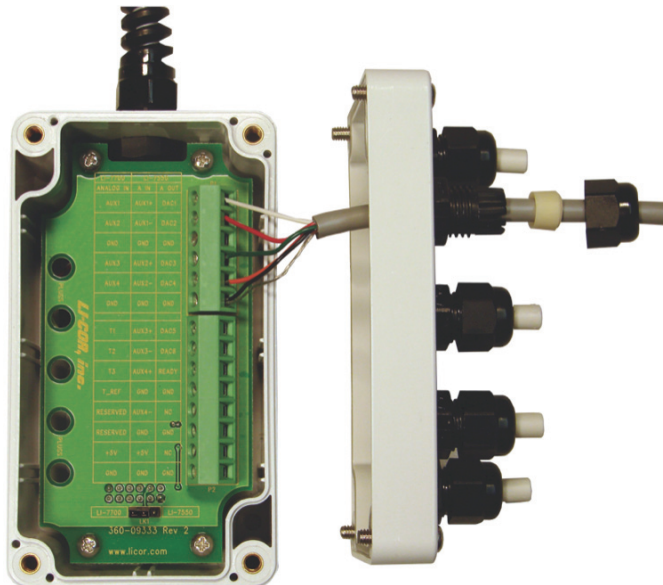

5. Insert the grommet into the gland plug and pull gently on the wires to remove slack from inside the interface. Attach additional sensor wires to the appropriate terminals.



- When you have finished installing all of your sensors, re-attach the interface top cover and tighten the gland plug caps.

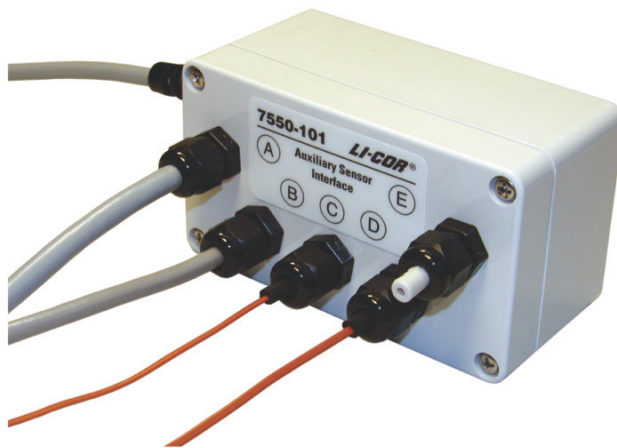

- Attach the Auxiliary Sensor Interface cable connector to the Analog Input connector on the LI-7700 connection panel.

There are 5 plastic plugs in the interface box gland plugs and 10 extras (p/n 300-07393) in the spares kit. These should be inserted into unused gland plugs on the Auxiliary Sensor Interface. The plugs prevent foreign materials (e.g., water, insects, dirt) from entering the interface box. Insert the narrow end of the plug through the gland plug and tighten the plug cap (as shown in plug E above). The plugs should always be used in any gland plug that does not have a wire.

There is also a length of Santoprene® tubing in the Auxiliary Sensor Interface spares kit. This tubing can be cut to length and placed around small gauge wires that may not be able to be tightened sufficiently with the gland plugs. It can also be used for oddly shaped wires that can be difficult to seal with the gland plug caps, as in plugs C and D above.

### ***Thermocouple Inputs***

The thermocouple inputs are designed to work with Type E thermocouples (chromel-constantan). The positive (+) thermocouple wire (chromel, purple insulation) should be connected to T1, T2, or T3. The negative (-) thermocouple wire (constantan, red insulation) should be connected to the T\_REF. All three channels share a common connection T\_REF. The range of thermocouple temperature measurements is  $\pm 20$  °C from the reference temperature inside the Auxiliary Sensor Interface.

Thermocouple readings can be influenced by rapid changes to the temperature or by heat loads to the auxiliary sensor interface. To avoid risk of these issues, shield the auxiliary sen-

sor interface from direct sun and/or thermally insulate the apparatus. A simple solution is to wrap the Auxiliary Sensor Interface with aluminum foil.

## Configuring Auxiliary Inputs (LI-7700)

Analog inputs are configured from the “Configure Auxiliary Inputs” dialog box (click ). Auxiliary inputs 1 through 4 are used with LI-7700 inputs (see Option 1, page 2-21). They are configured with the top four tabs in the Configure Auxiliary Inputs dialog box. One of two mathematical conversions can be applied to the input voltages: 1) a third order polynomial or 2) a Steinhart equation (for computing temperature in °C from a thermistor).

The polynomial can be used to scale inputs from a variety of sensors, such as thermistors or sonic anemometers. Below are several examples demonstrating ways that the polynomial and Steinhart equation can be used:

**Example 1:** The figure below shows how to wire and configure a thermistor for auxiliary inputs 1 to 4 (and 5 through 8). Set the “Type:” field to “Steinhart,” then set the coefficients.

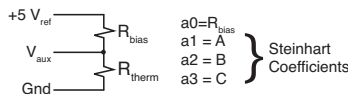

**Example 2:** These settings convert analog output voltage from a CSAT3 sonic anemometer (Campbell® Scientific, Inc.) to wind speed (m/s). In this example we demonstrate the “high range” (horizontal wind speeds up to  $\pm 65.563$  m/s, vertical wind speeds up to  $\pm 8.192$  m/s) scaled to  $\pm 5V$ . The median of the high ( $+65.563$ ) and low ( $-65.563$ ) values of the measurement range is the offset (0), and is entered in the **a0** field. The slope is found by

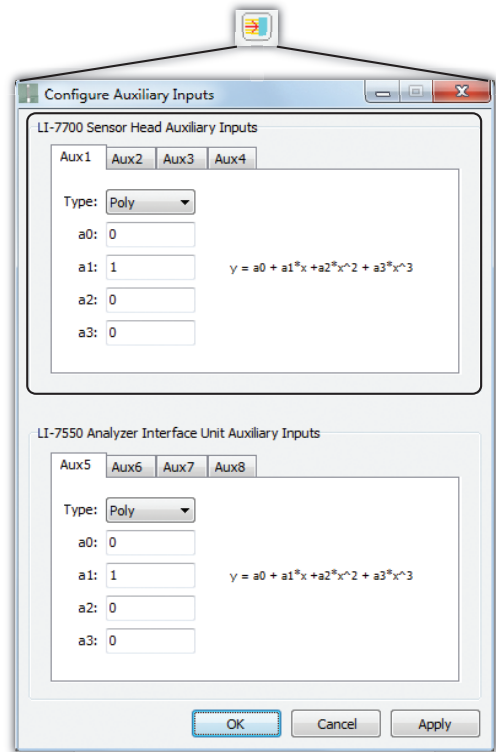

dividing the wind speed measurement range by the total voltage range:  $131.072 \text{ m s}^{-1} / 10\text{V} = 13.1072 \text{ m s}^{-1} \text{ v}^{-1}$ . If the leads for  $u_x$ , and  $u_y$  are connected to Aux1 and Aux2 inputs, set the Aux1 and Aux2 polynomial values for **a1** to 13.1072 and **a0**, **a2**, and **a3** = 0.

Mutlipliers for  $u_z$  are found similarly. With a measurement range of  $\pm 8.192 \text{ m s}^{-1}$ ,  $16.384 \text{ m s}^{-1} / 10\text{V} = 1.6384 \text{ m s}^{-1} \text{ v}^{-1}$ . Using Aux3 to log  $u_z$ , **a1**=1.6384; **a0**, **a2**, and **a3** = 0.

Using Aux4 to log the speed of sound, the terms **a1**=340 (offset), **a2**=6.5536 (slope) are given in the CSAT3 Instruction Manual. This is shown below. Refer to the CSAT3 Instruction Manual for more information.

LI-7700 Aux Channel	Aux1	Aux2	Aux3	Aux4
Polynomial Values	a0	0	0	340
(set in LI-7700 software)	a1	13.1072	13.1072	1.6384
	a2	0	0	0
	a3	0	0	0
Variable Logged	$U_x$	$U_y$	$U_z$	Speed of Sound
Units	Windspeed (m/s)			(m/s)

**Example 3:** This example describes how to convert analog signals from a Gill WindMaster™ or WindMaster Pro™ sonic anemometer in the  $\pm 50 \text{ m s}^{-1}$  wind speed range (speed of sound range of 300-370  $\text{m s}^{-1}$ ), with analog outputs scaled to  $\pm 5\text{V}$ .

The median of the low (-50) and high (+50) values of the measurement range is the offset (0), and is entered in the **a0** field. The voltage output range between -5 to +5V is 10V. To find the slope, divide the measurement range by the voltage range ( $100/10=10$ ). This value is the slope and is entered in the **a1** fields for Aux 1, 2, and 3.

For speed of sound, the median of the low (300) and high (370) values of the measurement range is the offset (335), and is entered in the **a0** field for Aux4. To find the slope, divide the measurement range by the voltage range ( $70/10=7$ ). This is entered in the **a1** field for Aux4.

LI-7700 Aux Channel	Aux1	Aux2	Aux3	Aux4
Polynomial Values	a0	0	0	335
(set in LI-7700 software)	a1	10	10	10
	a2	0	0	0
	a3	0	0	0
Variable Logged	U	V	W	Speed of Sound
Units	Windspeed (m/s)			(m/s)

Alternatively, you could compute °C rather than SOS with the following:  $T_s$  range= -40 °C to 70 °C. The median (15) is entered in **a0** for Aux4. The measurement range ( $|-40 - 70|=110$ ) divided by the voltage range ( $110 \text{ m s}^{-1} / 10\text{V} = 11 \text{ m s}^{-1} \text{ v}^{-1}$ ) is the slope and is entered in **a1** for Aux4. Refer to the WindMaster™/Pro User Manual for more information.

## Deploying the LI-7700 and Accessories

### Mounting the LI-7700

For field deployments, the LI-7700 must be firmly attached to a stable, secure instrument platform. For eddy covariance applications, be sure that the instrument is deployed in accordance to the guidelines set forth by the scientific community for eddy covariance data collection. For example, mounting the LI-7700 too close to the canopy may result in sampling in the roughness sub-layer, which is not representative of the study site. A vertical mounting orientation provides 360° acceptance for wind direction, and this is the recommended orientation. However it is oriented, the LI-7700 should be placed as close to the sonic anemometer as practical without affecting the airflow through the anemometer.

The LI-7700 mounting post is designed to fit securely into a 1" crossover fitting, similar to those used in many micrometeorological stations. Crossover fitting suppliers are listed on page 8-14.

To mount the LI-7700 on a weather station using a 1" (2.54 cm) crossover fitting:

1. Position the crossover fitting on the spar in the approximate position. It should mount so the LI-7700 is correctly positioned in relation to the sonic anemometer and other instruments. Securely tighten the hex-screws on the fitting.
2. Position the LI-7700 in the crossover fitting and tighten the hex-screws. Reposition the fitting as needed. **Be sure to securely tighten the cross-over fitting screws.** Attach the power and data cables. Route the cables and hoses so that they are not hanging from the LI-7700. Preferably, secure them to the tower with wire ties.
3. Connect the Ethernet cable from the LI-7700 to a data storage device.
4. Connect the power cable to a suitable power supply.



### Vibrations

The LI-7700 may be sensitive to vibration at certain high frequencies, which could affect the measurements. These frequencies are not typically experienced in tower mount applications. For land-based installations, one of the most likely sources of vibrational problems would be a tower with excessively tight guy wires. For other settings where there

may be vibrations in a problematic range, you should try to minimize vibration through alternative mounting attachments.

### **Positioning the LI-7700**

There are numerous factors to take into account when deploying the LI-7700 in eddy covariance flux applications. Addressing these concerns appropriately is critical to minimizing required frequency response corrections. Here we address two of these: instrument height above the canopy and proximity to the sonic anemometer.

For most applications, the LI-7700 and other sensors should never be within the canopy roughness sub-layer, as that may violate the assumptions of the eddy covariance flux method. The minimum recommended height above the canopy is 1.0 to 1.5 m or more, but this will vary depending on surface roughness and other factors.

As with all instrumentation in an eddy covariance flux system, the closer to the canopy, the closer the instruments must be to each other to minimize frequency response corrections for sensor separation. For deployments high above the canopy, the LI-7700 should still be as close as practical to the sonic anemometer, but larger vertical separations are now more acceptable. For example, at heights of 40 meters above the canopy, the anemometer sample path can be above the LI-7700 entirely.

For near surface deployments, the LI-7700 should be 10-30 cm horizontally from the anemometer, and they should have a minimal vertical separation.

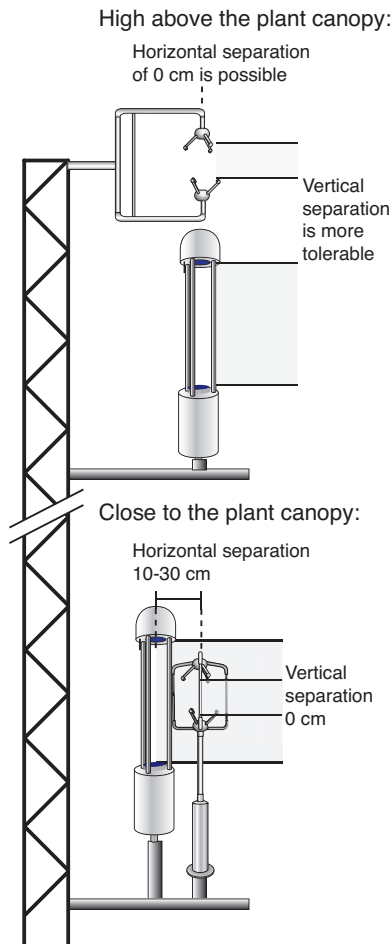

**Figure 2-6. Suggested mounting configurations for the LI-7700.**



**Important:** never put scalar measurements (e.g., the LI-7700) above the sonic anemometer, as it may lead to errors and require difficult-to-predict corrections.

### Grounding

The power supply, Ethernet, and analog inputs are all electrically isolated from each other and from the internal circuitry. There also are protection clamps in the form of spark gaps on the isolated circuits to the instrument chassis. For lightning protection, make sure the mounting structure for the instrument is electrically grounded, or run an independent bonding wire from the instrument mount to the earth.

### Mounting the 7550-101 Auxiliary Sensor Interface

The Auxiliary Sensor Interface has an attached mounting plate that can be used to attach the interface to a 1" to 1½" (2.5 to 3.8 cm) diameter post. Two U-bolts and four nuts are included in the 7550-101 spares kit. These can be used to attach the Auxiliary Sensor Interface as shown below in Figure 2-7. It can be mounted vertically or horizontally. If you do not want to use the attached mounting plate, remove the top cover of the box and remove the two screws (in opposite corners) that secure the box to the bracket. You can then secure the interface using wire, cable ties, or other methods of your choosing.

7550-101 Auxiliary Sensor Interface

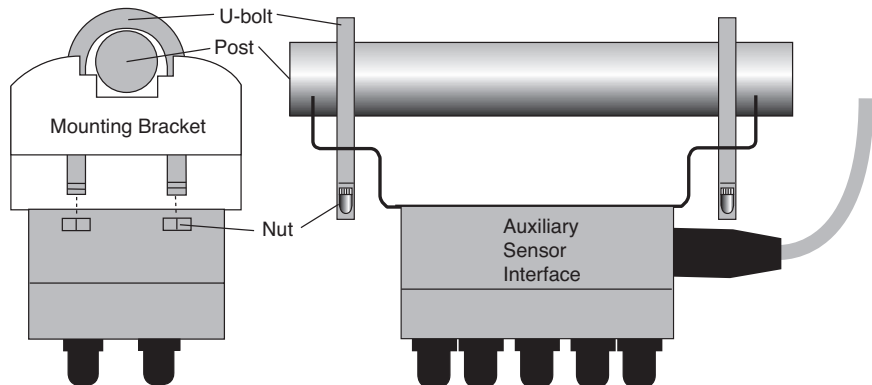

*Figure 2-7. Mounting the 7550-101 Auxiliary Sensor Interface.*

### Attaching the Mirror Cleaner/Washer Assembly

Follow the steps below to attach the mirror cleaner.

1. Attach the spray nozzle assembly (p/n 9977-032) to a spar on the LI-7700, as shown below. It snaps into place.
2. Attach the “Quick Connect” hose fitting on the nozzle/hose assembly to the fitting on the washer reservoir (p/n 7700-101).
3. Connect the washer motor power cable (p/n 392-10211) to the washer power connection on the LI-7700 connection panel and to the connection on the washer reservoir.
4. Fill the washer with regular automotive windshield washer fluid or an environmentally friendly alternative. If there is risk of freezing temperatures, select a washer fluid that will not freeze.
5. To verify spin motor operation, set the Control Setting to “On” and click “Apply” in the Manual Controls window. After observing operation of the spin motor (the pump will not run, see below), set the Control Setting to “Off” and click “Apply.”



**Note:** While you may use the “On” setting to manually spin the mirror, the fluid pump will not power up. It is controlled exclusively by the time scheduling algorithm. If you wish to test the connections and ensure that the pump will power up, set the Spin Motor Control to “Automatic” with a time window that will allow the instrument to power up the pump (see page 2-11).

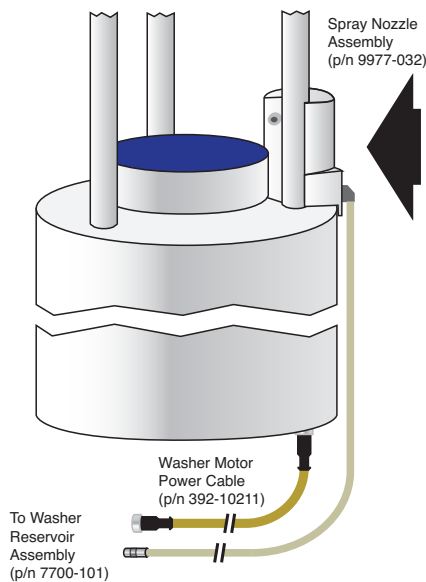

**Figure 2-8. Washer nozzle assembly and washer power cable connections.**

## Mounting the Washer Reservoir

Two brackets (included) can be used to mount the 7700-101 Washer Reservoir to a tripod or other post using bolts or U-bolts. The hardware required for this is included. Alternatively, the four holes in the corners of the box can be used to attach the box directly to a flat surface. Mounting the 7700-101 is identical to the LI-7550 (see page 3-29).

The mounting brackets are designed to accommodate a square or circular mounting post up to 1.25" (3.2 cm) in width (diameter). Use a 3/16" hex key to attach the mounting brackets to the Analyzer Interface Unit using the 4 socket head screws (p/n 140-02654). The U-bolts can then be inserted through the holes in the mounting bracket, and tightened around the post.

### Additional Considerations:

1. The cables and hose are 5 meters long. The washer reservoir must be within 5 meters of the LI-7700. The pump is powerful enough to lift the washer fluid 5 meters, but attempts to lengthen the washer hose will result in reduced fluid pressure, which will affect the performance of the pump and mirror cleaner.
2. An additional reservoir can be used with the 7700. This might be necessary in circumstances in which the washer fluid may be used quickly.

The following schematic shows a basic LI-7700 configuration with the washer reservoir, analog input cable, and a sonic anemometer. In this configuration, power is supplied to the sonic anemometer and the LI-7700. Data are output through Ethernet to a suitable data storage device.



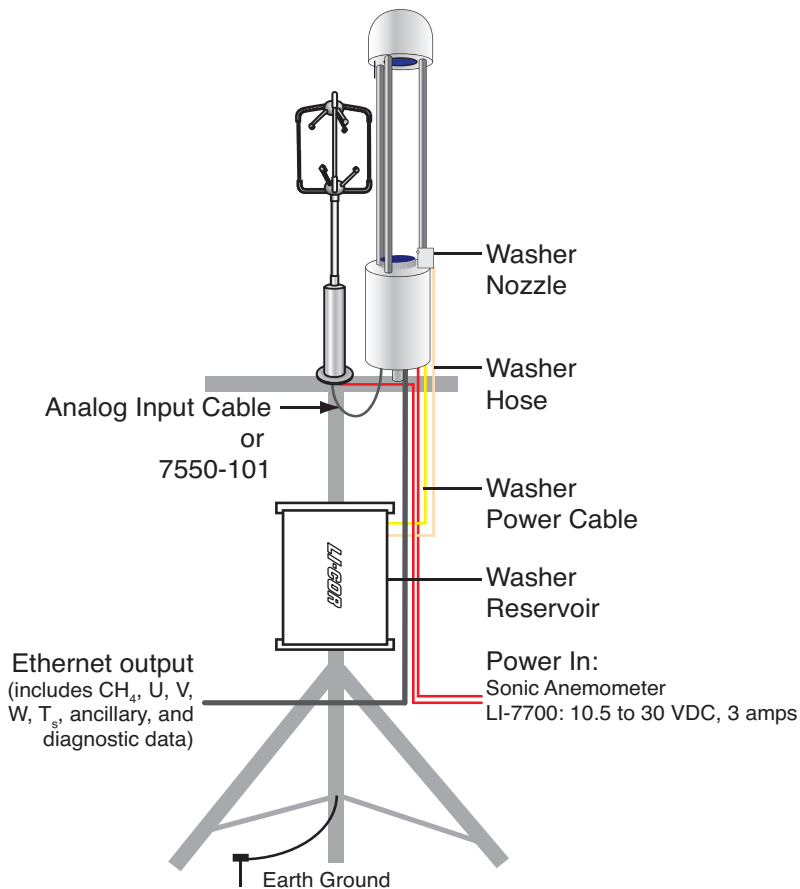

**Figure 2-9.** *A typical field deployment of the LI-7700 and accessories. For eddy covariance flux applications, water vapor flux must also be measured. This can be accomplished with an LI-7500, LI-7500A or LI-7200 CO<sub>2</sub>/H<sub>2</sub>O Analyzer (not shown).*

# 3 Operation with the LI-7550 Analyzer Interface Unit

---

## Introduction to the LI-7550

The LI-7550 is available as an accessory for the LI-7700 Open Path CH<sub>4</sub> Analyzer. When used with the LI-7700 it provides:

- Logging of eddy covariance data sets to a removable USB storage device.
- Ethernet communication/data transfer.
- RS-232 serial communications.
- SDM data output for Campbell® Scientific, Inc. dataloggers.
- 6 high-speed, scalable Digital-to-Analog converters (16 bit, ±5V).
- 4 additional analog inputs (16 bit, differential, ±5V).



*Figure 3-1. Inside the LI-7550.*

The LI-7550 is a standard component of the LI-7500A/7200 CO<sub>2</sub>/H<sub>2</sub>O Analyzers and GHG analyzer systems. In these configurations, the LI-7550 requires embedded firmware that is specific to the LI-7500A/7200, and certain features described here are not available. This section describes the functionality that is provided when the LI-7550 is running LI-7700 embedded firmware, as well as some instructions for LI-COR GHG systems.

## What's What

If you just received your LI-7550, check the packaging list and verify that you received everything that was ordered. Most items are part of the standard spares kit.

### Spares Kit and Cables

The standard LI-7550 spares kit (p/n 9975-023) includes the following items:

#### LI-7550 Analyzer Interface Unit Spares Kit

Description	Qty.	LI-COR Part No.
Mounting Hardware Kit	1	9972-029
RS-232 Interface Cable	1	392-10268
Power Cable	1	9975-030
Analog Input/Output Cable	1	392-10109
Ethernet Cable, Eurofast (5 M) 8-pin male to 8-pin male	1	392-10108
Ethernet Cable, Eurofast (0.3 M) 8-pin female to RJ45	1	392-10107
SDM Interface Cable	1	392-10093
5 Amp Fuse	2	439-04214
4 GB USB Flash Drive	1	616-10723

- **Power Cable** - The power cable (p/n 9975-030) is 5 m long. It has a 4-pin female terminal plug that attaches to the connector labeled **POWER** on the LI-7550 Analyzer Interface Unit connection panel. The power cable is terminated with black (-) and red (+) leads for connection to a user supplied 10.5-30 VDC power supply.

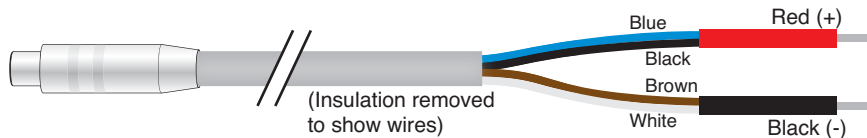

- **Ethernet Cables** - Two Ethernet Cables (p/n 392-10107 and 392-10108) are included for connecting to a Local Area Network (LAN) or computer via an Ethernet port. Part # 392-10108 is a 5m cable terminated on both ends with male Turck connectors. One end attaches to the LI-7550 Analyzer Interface Unit, and the other end attaches to the short (0.3m) Ethernet adapter cable (p/n 392-10107). The short cable is terminated with an RJ45 Ethernet connector, which plugs into an Ethernet wall socket or a computer's Ethernet port.

- **SDM Interface Cable** - The SDM interface cable (p/n 392-10093) is for connecting to Campbell® Scientific, Inc (Logan, Utah) dataloggers using the Synchronous Devices for Measurement (SDM) data communication protocol. SDM communications are enabled in the Campbell® Scientific datalogger. The SDM interface cable plugs into the connector labeled **SDM** on the LI-7550 Analyzer Interface Unit connection panel. See page 3-21 for SDM modes and configuration information. SDM wire colors and pin assignments are given in Figure 3-3.
- **4 Gigabyte USB Flash Drive** – A 4 GB industrial grade USB flash drive is included in the spares kit. Additional industrial grade 16 GB and 4 GB flash drives are available for purchase directly from LI-COR (see 8-14).
- **Serial RS-232 Cable** - The RS-232 cable (p/n 392-10268) is a 5m null modem cable with a 6-pin female circular connector that attaches to the connector labeled **RS-232** on the LI-7550 Analyzer Interface Unit connection panel. The other end has a standard DB-9 female connector for direct connection to a computer. Alternatively, the RS-232 cable can be connected to an RS-232-to-USB adapter to use the RS-232 connection with a USB port.
- **Analog Input/Output Cable** - The Analog Input/Output Cable (p/n 392-10109) is for connecting user-supplied sensors (i.e., pressure, temperature, sonic anemometer) to LI-7700 or LI-7550 analog inputs and/or for connecting the LI-7550 analog outputs to a data logger. The pin assignments and wire colors are shown in Figure 3-3. There are four analog input channels available. When used with external input devices, this cable plugs into the connector labeled **AUXILIARY INPUT** on the LI-7550 Analyzer Interface Unit connection panel (similar to Option 2 on page 2-20, pin assignments given on page 3-17).

This cable can also be used for data output to logging devices using the digital-to-analog converters (DACs). Six DAC channels are available; the pin assignments and wire colors are shown in Figure 3-3. The cable plugs into the connector labeled **DAC OUTPUT** on the LI-7550 Analyzer Interface Unit connection panel (similar to Option 3 on page 2-20, pin assignments given on page 3-28).

This cable can also be used to connect directly to sensors or output devices; the optional weatherproof Auxiliary Interface Unit (p/n 7550-101) can be used in place of this cable. Use of the 7550-101 with the LI-7700 is described in the previous chapter, and with the LI-7550 is described later in this chapter. Note that only one Analog Input/Output cable is included with the LI-7550. If you intend to use both the Auxiliary Input and DAC Output ports on the LI-7550 you can acquire an additional 392-10109 cable or the 7550-101 Auxiliary Sensor Interface.

## Cable Connections

Cable connections are found on the bottom panel of the LI-7550. Each connection includes a dust/moisture cover that should be kept in place any time the connection is not in use.

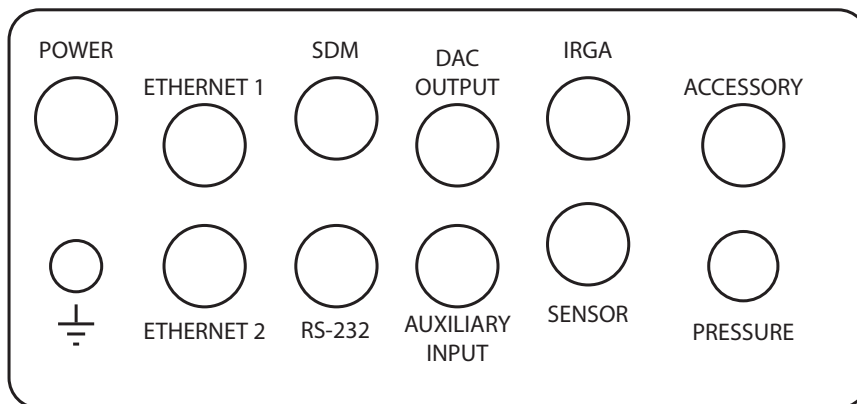

**Figure 3-2. LI-7550 connection panel.**

The LI-7550 includes a variety of cables for connecting power, sensors, and external data storage devices. All cables are 5 meters in length and are manufactured by Turck, Inc. (Minneapolis, MN, see page 8-13). If you need longer cables, several custom-length cables can be purchased from Turck, Inc. Table 3-1 below lists both LI-COR part numbers and the corresponding Turck part numbers for each cable. You can also construct your own extension cables. Figure 3-3 lists pin assignments and wire colors for the power, SDM, and Analog Input and Output cables. This table is reproduced inside the front cover of the LI-7550 Analyzer Interface Unit.

**Table 3-1. Turck Eurofast® cables used to connect to the LI-7550. An asterisk (\*) refers to cable length. Note that the maximum length of some cables may be limited (SDM, Serial, and Analog).**

LI-COR p/n	Cable	Connection	Turck p/n
9975-030	Power	4-pin female	RK4.41T-*/S529
392-10093	SDM Interface	4-pin male	RSS 4.4T-*
392-10268	Serial	6-pin female to DB-9 female	RKC 6T- DB9F/CS12317
392-10109	Analog In/Out	12-pin male	RSS 12T-*
392-10108	Ethernet	8-pin male-male	RSS RSS841-*M
392-10107	Ethernet Adapter	8-pin female to RJ45	RKC RJ45 840-*M

Inside the LI-7550 there are three Ethernet ports and one port for a USB data storage device. Two of the Ethernet ports are connected to the Ethernet ports on the connection panel (see Figure 3-2). It does not matter which ports these internal cables are connected to. The third port is not connected to the panel, but can be used to connect an Ethernet device, such as a laptop computer.





LI-7550 Pin Assignments								
SDM			ANALOG IN			ANALOG OUT		
PIN 1	BROWN	SDM_EN	PIN 1	WHITE	AUX1+	PIN 1	WHITE	DAC1
PIN 2	WHITE	SDM_CLK	PIN 2	BROWN	AUX1-	PIN 2	BROWN	DAC2
PIN 3	BLUE	SDM_DATA	PIN 3	GREEN	AUX2+	PIN 3	GREEN	DAC3
PIN 4	BLACK	GND	PIN 4	YELLOW	AUX2-	PIN 4	YELLOW	DAC4
COUPLING	BARE	EARTH GND	PIN 5	GREY	AUX3+	PIN 5	GREY	DAC5
POWER			PIN 6	PINK	AUX3-	PIN 6	PINK	DAC6
PIN 1	BROWN BLACK	VIN-	PIN 7	BLUE	AUX4+	PIN 7	BLUE	READY
PIN 2	WHITE	VIN-	PIN 8	RED	AUX4-	PIN 8	RED	NC
PIN 3	BLUE RED	VIN+	PIN 9	ORANGE	+5V	PIN 9	ORANGE	NC
PIN 4	BLACK	VIN+	PIN 10	TAN	GND	PIN 10	TAN	GND
INPUT: 10 - 30VDC 			PIN 11	BLACK	GND	PIN 11	BLACK	GND
FUSE: 5A F 125/250V 			PIN 12	VIOLET	GND	PIN 12	VIOLET	GND
 <b>USB LOGGING - USE INDUSTRIAL GRADE ONLY!</b>						 Biosciences LI-COR Biosciences 4647 Superior St. Lincoln, NE 68504 1-800-447-3576 (U.S. & Canada) 402-467-3576 FAX: 402-467-2819 envsales@licor.com • envsupport@licor.com www.licor.com		
<ul style="list-style-type: none"> <li>● SOLID LED - DRIVE MOUNTED, NOT LOGGING</li> <li>●●●● RAPID BLINK - LOGGING</li> <li>● ● SLOW BLINK - ERROR. EJECT AND RETRY</li> <li>○ NO LED - DRIVE NOT MOUNTED, OK TO REMOVE</li> </ul> <p><b>WARNING!</b> FAILURE TO PRESS EJECT BUTTON BEFORE REMOVING USB DRIVE WILL RESULT IN LOSS OF DATA!</p>								

Figure 3-3. LI-7550 internal label.

## Basic Setup

### Power On

The LI-7550 has no power switch – it turns on when power is supplied through the power cable (10.5-30 VDC, 2 amps). When power is supplied the “Power” LED on the indicator panel will illuminate, and it will stay lit as long as power is supplied. The “Ready” LED will turn on when the instrument embedded software has launched and the LI-7550 is ready to communicate with a computer.

### Connecting to the LI-7700 and LI-7550 (Ethernet)

The LI-7700 connects to the LI-7550 using the Ethernet cable (p/n 392-10108), which terminates with Turck® connections on both ends. Attach one terminal to the Ethernet connection on the LI-7700 and the other to either the Ethernet 1 or 2 terminals on the LI-7550 connection panel (see Figure 3-2). You can now connect the LI-7550 to a computer or network with the vacant Ethernet port on the LI-7550 connection panel (using the Ethernet cables p/n 392-10108 and p/n 392-10107 in series), or the vacant Ethernet port inside the box (with a user-supplied Ethernet cable).

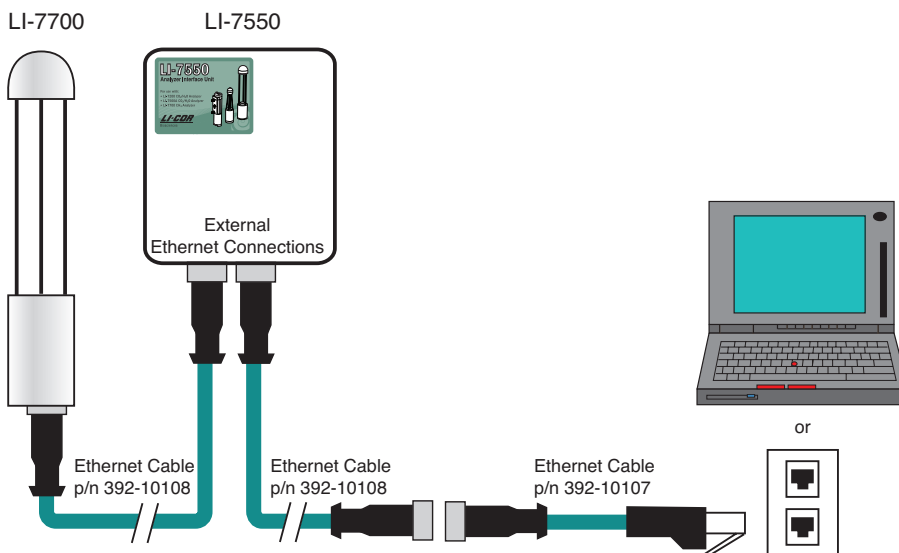

**Figure 3-4. Ethernet data cable connections for the LI-7700 and LI-7550.**

## Getting an LI-7700 to talk to an LI-7550



**Note:** The LI-7550 can run two versions of software. One version is required when using the LI-7700 with the LI-7550 exclusively (not with the LI-7500A or LI-7200 CO<sub>2</sub>/H<sub>2</sub>O Analyzer). The other version is required when using the LI-7700 in conjunction with the LI-7500A or LI-7200 CO<sub>2</sub>/H<sub>2</sub>O Analyzer. Regardless of which software the LI-7550 is running, follow the steps below to get the LI-7700 to talk to the LI-7550. If you are using the LI-7700 with an LI-7500A or LI-7200 CO<sub>2</sub>/H<sub>2</sub>O Analyzer, refer to page 3-9 for more information.

Prior to using the LI-7700 with an LI-7550, the two devices must be configured to communicate with each other. To accomplish this:

1. Connect power to both devices. Connect the LI-7700 and LI-7550 with the Ethernet cable, as described above. Connect the LI-7550 to your computer or network with the Ethernet cable. Be sure to use a computer that has the LI-7700 Windows Application software (see page 1-9).
2. Launch the Windows Application software but do not connect to an instrument.
3. Click the **Help** icon  and click **About**.

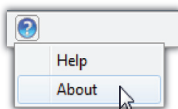

4. In the “About” dialog box (below, left) click **Factory Setup...** then click **Proceed** in the warning that appears (below, right).

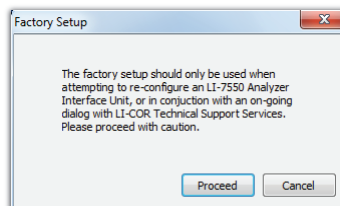
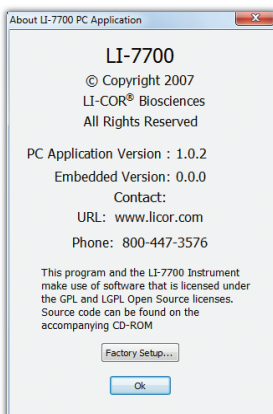



- In the “Factory Setup” dialog box you should see both the LI-7700 and the LI-7550, similar to the figure below.

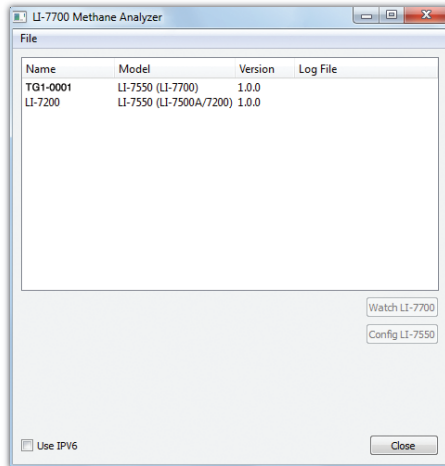

- Click on the LI-7550, then click the **Config LI-7550** button.
- In the resulting dialog box, confirm that the text in the field called “Head:” matches the text on the Factory Setup display for the name of the LI-7700 Analyzer (it is not case sensitive), or edit the field so they match. In this case, the name is “TG1-0001”, as shown below.

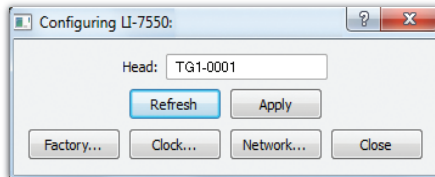

- If you changed the name, click the **Apply** button to confirm the name change. Restart both devices by disconnecting and reconnecting the power supply.
- Confirm that the two devices are communicating by connecting to the LI-7700 with the Windows Application software. Insert a USB storage device into the LI-7550 USB port. If the USB device appears in the “USB Logging” window (see page 3-12), both are configured correctly.

## Using an LI-7700 with an LI-7500A or LI-7200 CO<sub>2</sub>/H<sub>2</sub>O Analyzer

The LI-7700 can be used in conjunction with an LI-7500A or LI-7200 CO<sub>2</sub>/H<sub>2</sub>O Analyzer, but there are a few differences that you should be aware of. As mentioned earlier, there are two versions of software available for the LI-7550 Analyzer Interface Unit. One version is specifically for using the LI-7550 with an LI-7700. If you ordered an LI-7700 with an LI-7550 (but not an LI-7500A or LI-7200), the LI-7550 will have the LI-7700 software installed.

A second software version is specifically for using an LI-7550 with an LI-7500A/7200. If you received an LI-7550 as part of a CO<sub>2</sub>/H<sub>2</sub>O Analyzer or with a GHG-1/GHG-2 system, the LI-7550 will have the LI-7500A/LI-7200 software installed. The latter software configuration is required any time you use the LI-7550 with both an LI-7500A/7200 CO<sub>2</sub>/H<sub>2</sub>O Analyzer and an LI-7700 CH<sub>4</sub> Analyzer.

Which software is the LI-7550 running? There is a sticker inside the LI-7550 that indicates the software version that was loaded at the factory. You can also find the software version by following the steps below:

1. Connect the LI-7550 Analyzer Interface Unit to a suitable power supply, then connect the Ethernet cables to enable communication with your computer.
2. Launch the LI-7700 Windows Application software but do not connect to an instrument.
3. Click the **Help** button  and click **About**.
4. In the **About** dialog, click **Factory Setup...**, then click **Proceed** in the warning dialog. You should see window similar to the figure below.

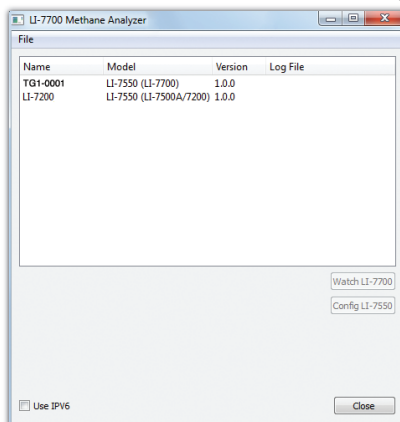

### 3 Operation with the LI-7550 Analyzer Interface Unit

5. The LI-7550 will be listed. If the LI-7550 is configured for the LI-7700, under the “Model” heading, it will read “LI-7550 (LI-7700).” If it is configured for an LI-7500A or LI-7200, it will read “LI-7550 (LI-7500A/7200).”

If the LI-7550 is configured to support an LI-7500A/7200 CO<sub>2</sub>/H<sub>2</sub>O Analyzer, you can log LI-7700 and Auxiliary Input 1-4 data to the LI-7550 USB device in a separate file from the one generated by the CO<sub>2</sub>/H<sub>2</sub>O analyzer. However, you cannot set up the Auxiliary Inputs 5-8, SDM, RS-232, or DAC outputs from the LI-7700 Application software, nor can you output methane analyzer data using SDM, RS-232, or DACs. Instead, use the LI-7500A/7200 Windows Application software to configure those channels. The software will prohibit you from opening the “Configure LI-7550 Outputs” dialog from the LI-7700 application. Conversely, if the LI-7550 is formatted to operate with an LI-7700, you will have access to all functions in the software, but it will be unable to communicate with an LI-7500A/7200.

When using the LI-7700 in conjunction with an LI-7500A/7200 CO<sub>2</sub>/H<sub>2</sub>O Analyzer using a shared LI-7550, data output is limited to Ethernet. All data can be logged to the internal USB storage device.



**Note:** If you are logging data from a sonic anemometer in conjunction with CH<sub>4</sub>, CO<sub>2</sub>, and H<sub>2</sub>O data, sonic anemometer signals must be split and logged with both the LI-7700 data stream (using Auxiliary Inputs 1-4 on the LI-7700) and with the LI-7500A/7200 data stream (using Auxiliary Inputs 1-4 on the LI-7550). Furthermore, the LI-7700 inputs are single ended, whereas the LI-7550 inputs are differential, and they must be configured accordingly. LI-COR manufactures sonic anemometer interface cables with pre-configured pin-outs for Gill WindMaster™/Pro and Campbell® Scientific CSAT3 anemometers. Contact us to learn more about these accessories.

## Connecting to the LI-7700 and LI-7550 (RS-232 Serial)



**Note:** The procedures described in the previous section are only available when the LI-7700 and LI-7550 are connected using the Ethernet port. While the RS-232 connection does allow you to configure the LI-7700, and data can be output using the serial connection, the “Factory Setup” application (aka, LI-7700 Finder Application) will not find an LI-7700 or LI-7550 that is connected via the serial connection.

The LI-7550 enables RS-232 communications with the LI-7700. Prior to connecting with RS-232, follow the instructions on page 3-7 to enable communication between the LI-7550 and LI-7700. Then, connect the LI-7550 to your computer’s RS-232 connection with the RS-232 adapter cable (p/n 392-10268) and connect the LI-7700 to the LI-7550, as shown below. An RS-232 to USB adapter may be required (392-07713).

To connect, launch the LI-7700 software, click “Connect”, check the “RS-232” button, and choose the COM port (between 1 and 32) that the instrument is connected to. Click the “Connect” button.

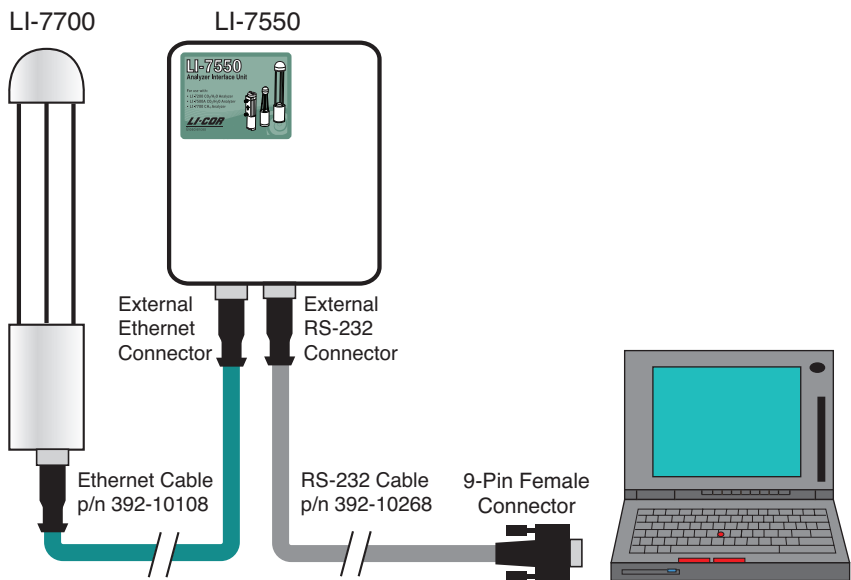

**Figure 3-5. RS-232 Cable configuration for the LI-7700 and LI-7550. The Ethernet data cable is still used to connect the LI-7700 to the LI-7550, while the RS-232 cable connects the LI-7550 to the computer.**

## Using the LI-7550

The LI-7550 is configured through the LI-7700 software. When settings are configured in the LI-7700 software, this information is stored in the LI-7700. Then the LI-7550 pulls this information from the LI-7700 when the two components are connected and powered up.



**Note:** If the LI-7550 is configured to support an LI-7200 or LI-7500A, it will not be possible to configure Auxiliary Inputs (Aux5 to Aux8), SDM, RS-232, or DAC outputs from the LI-7700 application software. The software will prohibit you from opening the “Configure LI-7550 Outputs” dialog from the LI-7700 application. See page 3-9 for more details. These features can be configured in the CO<sub>2</sub>/H<sub>2</sub>O analyzer software; however, they will only apply to the CO<sub>2</sub>/H<sub>2</sub>O analyzer data.



### USB Data Logging

USB data storage (with the LI-7550) is configured in the Logging frame. These settings are configured through the LI-7700 software and implemented automatically when the LI-7700 is connected with an LI-7550 and both instruments are powered up.

To log data to a LI-7550:

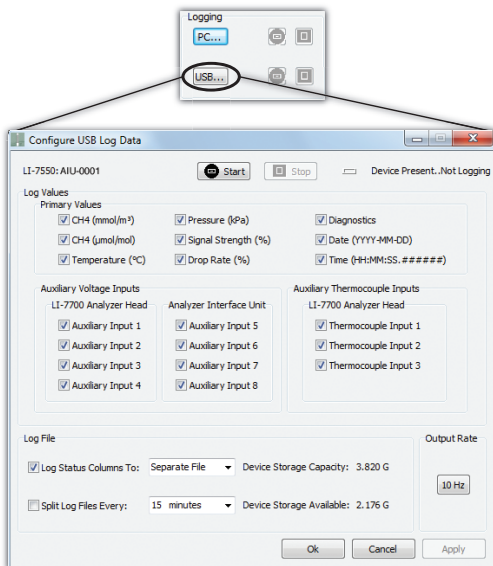
1. Click the **USB...** button in the Logging frame.



2. In the “Configure USB Log Data” dialog box, select the variables that you would like to log and click **Apply**. Auxiliary Inputs 1-4 and Thermocouple Inputs 1-3 are described on page 2-21 (Option 1), and Auxiliary Inputs 5-8 are described on page 3-16 (Option 2).
3. In the “Log File” frame, choose to Log Status Columns to a separate file or to the data file. Then choose whether to split the file, and how often (from 15 minutes to 24 hours). Click **Apply**.
4. To begin logging data immediately click a **Start** button () or (). Otherwise, logging will begin automatically when a USB storage device is inserted into the USB port, or when the instruments are restarted (if a suitable USB drive is present).
5. To remove the USB storage device press the “Eject” button in the LI-7550. The LI-7550 will stop writing data until another USB device is inserted, after which it will immediately begin logging data.

The LED by the USB port indicates the status of data logging with a blinking pattern, as described in Figure 3-6.

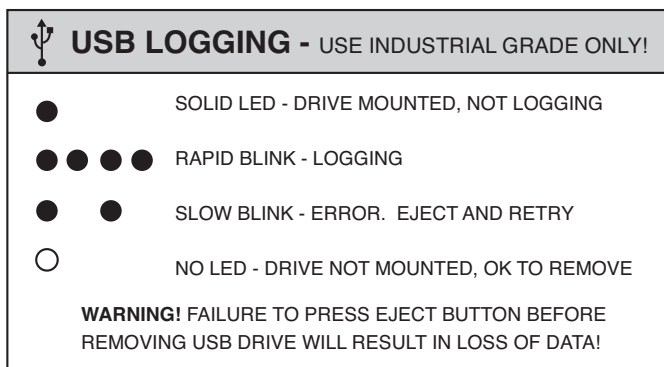

**Figure 3-6. USB Logging LED indicators.** This cable is printed inside the LI-7550 front cover.

#### About USB Devices

Many user-supplied industrial grade flash drives are compatible with the LI-7550, but some devices with custom drivers or encryption may not work. The drive must be formatted to support FAT or Linux ext3 file systems. FAT32 is recommended over FAT16.



**Important:** We recommend that you only use an industrial rated USB flash drive. Non-industrial rated flash drives can fail, causing you to lose data.



**Note:** Data logging will stop when the storage device has reached capacity, but will automatically resume when a USB storage device is reattached, assuming it has storage space available. Data logging also automatically starts when the instrument starts up, following a power interruption for example. Storage devices that are being used for the first time may take about 60-90 seconds to initialize before data will be written to the device.

#### USB Storage Capacity

The LI-7550 includes a 4 GB USB flash drive. If you are logging all 20 variables at 10 Hz (samples/second), the 4 GB flash drive can log data for about 22 days before becoming full. Table 3-2 shows approximately how long the LI-7700 can store data before a 4 GB USB drive becomes full.

*Table 3-2. Approximate number of days that the LI-7700 can record data before a 4 GB flash drive becomes full.*

Variables Logged	Time to fill a 4 GB drive
All (including status and diagnostics)	~22 days
All (including status but not diagnostics)	~27 days
CH <sub>4</sub> (mmol/m <sup>3</sup> ), Temp., Pressure, Signal Strength, Drop Rate, Status, and Aux. Inputs 1 to 4	~44 days

## Analog Inputs (LI-7550)

Analog inputs (Option 2) are configured from the “Configure Auxiliary Inputs” dialog box (click ). These are labeled Aux5 through Aux8 in the lower block of inputs. Two mathematical conversions of analog input voltages can be configured in the dialog box: 1) a third order polynomial or 2) a Steinhart equation (for measuring temperature with a thermistor).

These are described in detail on page 2-25, Configuring Auxiliary Inputs (LI-7700). After configuring the inputs, click **Apply** or **OK** to implement the settings.

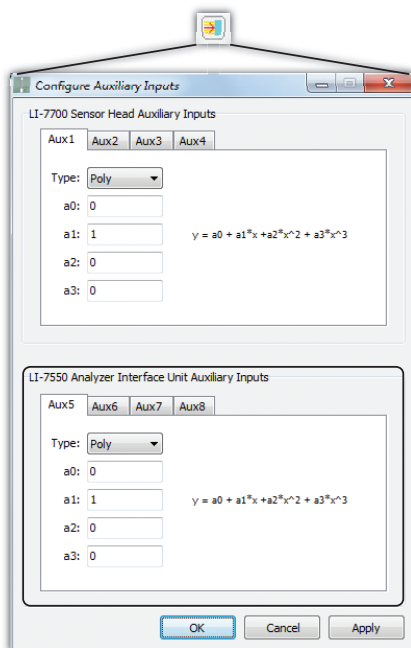

As mentioned previously, the 7550-101 can serve as a terminal strip for analog inputs or outputs for the LI-7550. Alternatively, the Analog Input/Output Cable (p/n 392-10109) can be used. To use Options 2 or 3 (Figure 2-3) with the 7550-101, be sure the LK1 jumper is positioned over the two pins nearest the LI-7550 label. Refer to page 2-21 for information on the LI-7700 analog inputs (Option 1). Below we describe how to configure the 7550-101 and the corresponding wires/pins in the Analog Input/Output Cable for LI-7550 analog inputs.



### *Auxiliary Sensor Interface Terminals (Option 2)*

To gain access to the inside of the 7550-101, loosen the four #1 Philips screws on each corner of the top cover. Remove the cover. The schematic below shows the interior of the interface box.

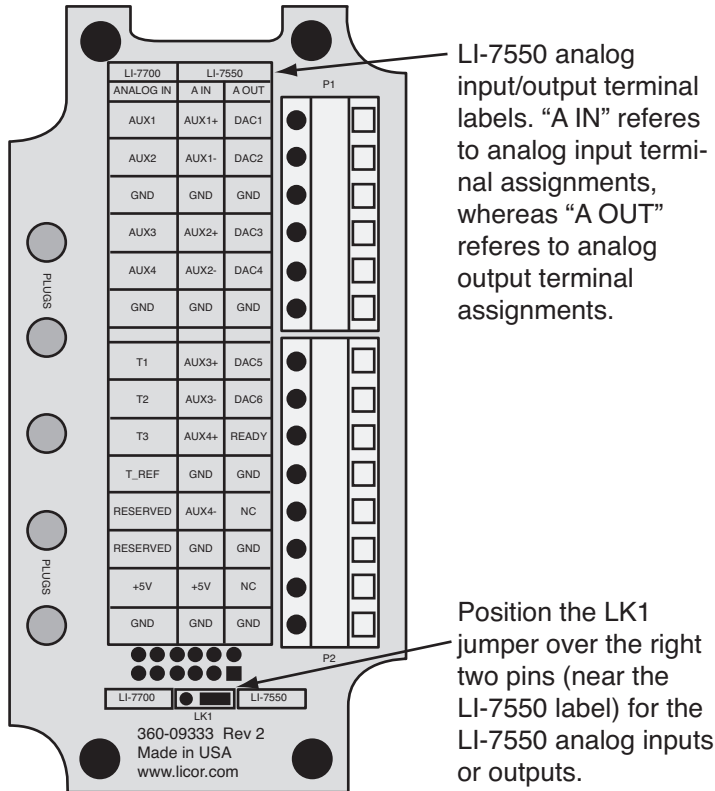

*Figure 3-7. Schematic of the Auxiliary Interface Unit interior.*

The terminal strips connections are shown below:

### When Used for Analog Inputs (LI-7550)

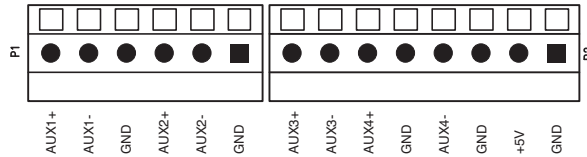

**Figure 3-8. Terminal connections for analog inputs (Option 2).**

Table 3-3 shows Auxiliary Sensor Interface input assignments and corresponding wire colors for the input cable.

**Table 3-3. LI-7550 Analyzer Interface Unit analog inputs for the 7550-101 Auxiliary Sensor Interface and Analog In/Out Cable.** 7550-101 terminals and input functions are on the left and corresponding Analog In/Out Cable wire colors and pin assignments are on the right.

7550-101 Auxiliary Sensor Interface		Option 2 <sup>a</sup>		
Terminal	Inputs	Description	Wire Color	Pin
1	AUX1+	Auxiliary Input 1 positive	White	Pin 1
2	AUX1-	Auxiliary Input 1 negative	Brown	Pin 2
3	GND	Ground	Tan	Pin 10
4	AUX2+	Auxiliary Input 2 positive	Green	Pin 3
5	AUX2-	Auxiliary Input 2 negative	Yellow	Pin 4
6	GND	Ground	Tan	Pin 10
7	AUX3+	Auxiliary Input 3 positive	Grey	Pin 5
8	AUX3-	Auxiliary Input 3 negative	Pink	Pin 6
9	AUX4+	Auxiliary Input 4 positive	Blue	Pin 7
10	GND	Ground	Black	Pin 11
11	AUX4-	Auxiliary Input 4 negative	Red	Pin 8
12	GND	Ground	Violet	Pin 12
13	+5V	+5V supply (10 mA max.)	Orange	Pin 9
14	GND	Ground	Tan	Pin 10

<sup>a</sup> Analog Inputs  $\pm 5V$

### Electrical Connections

All analog devices connected to the 7550-101 Auxiliary Sensor Interface must be referenced to the ground (GND) connection to use Option 2. Some examples are shown below.

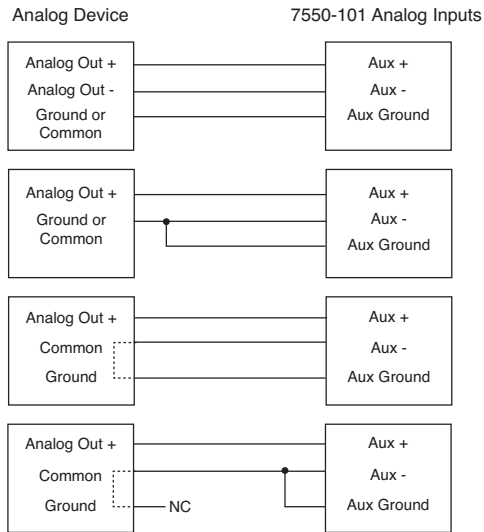

#### Connection Notes:

1. All LI-7550 auxiliary analog input ground connections are internally connected together.
2. All LI-7550 auxiliary analog output ground connections are internally connected together.
3. Analog devices with both ground and common outputs can share these outputs with their power supply ground.
4. LI-7550 analog inputs are electrically isolated from the LI-7550 power input.
5. LI-7550 analog outputs are electrically isolated from the LI-7550 power input and isolated from the analog inputs.

For additional 7550-101 & Analog Input/Output usage instructions, refer to the following pages:

- LI-7700 Inputs (Option 1) instructions: page 2-21
- Wiring instructions: page 2-23
- Mounting instructions: page 2-29
- Configuring LI-7550 Analog Outputs (Option 3): page 3-26

### ***Analog Input Time Delays***

Data from Auxiliary Inputs 5-8 (available only on the LI-7550) have a fixed time delay of 1 second. These values are shifted together in the data files by 1 second from data acquired with the LI-7700, Auxiliary Inputs 1-4, and the thermocouple inputs.

### LI-7550 Clock

The LI-7550 clock is separate from the LI-7700 clock, but it also uses Unix (POSIX) time and the Precision Time Protocol (see page 2-16) unless the LI-7550 is configured for an LI-7500A or LI-7200. When the two components are used together, set the LI-7700 clock to “automatic” and the LI-7550 clock to “preferred.” This will ensure that the time stamp comes from the LI-7550. The LI-7550 clock has the same setting options as the LI-7700 clock. To view/set the time in the LI-7550:

1. Connect the LI-7550 to your computer using the Ethernet, or to your network or computer using the Ethernet cable (RS-232 does not support this).
2. Launch the LI-7700 software, click the **Help** button , and select **About**.

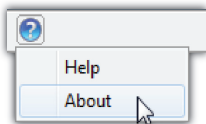

3. Click **Factory Setup...** and click on **Proceed** after reading the warning.
4. Select the “Base Box” (under the Model heading it will be called LI-7550) and click on **Config LI-7550**.
5. Click on the **Clock...** button.

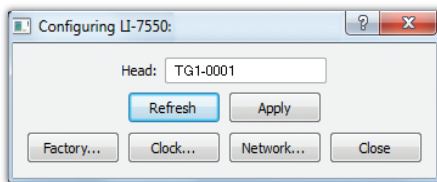

6. Configure the clock settings as desired. In the “Precision Time Protocol” frame, choose “Automatic”, “Slave Only”, or “Preferred Clock.” “Automatic” is the recommended setting when using the LI-7550 with the LI-7700.

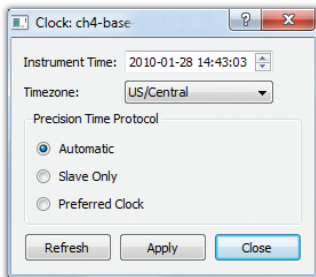

7. Apply the settings and close the dialog.

## LI-7550 Outputs

### Ethernet

Ethernet output from the LI-7700/7550 combination is configured in the same way as LI-7700 Ethernet output. This is described on page 2-6, PC/Network Data Logging (Ethernet Output).

### SDM

SDM addressing allows for multiple SDM-compatible peripherals to be connected to a single Campbell® Scientific, Inc datalogger. To log the SDM output from the LI-7700, first set up the LI-7700 using the Windows® software, then program the datalogger to poll the LI-7700 for data. The blue wire (SDM\_DATA) should be connected to datalogger terminal C1, white (SDM\_CLK) to terminal C2, and brown (SDM\_EN) to C3. Black and bare leads attach to datalogger ground terminals.

### Configuring LI-7700 SDM Output:

1. In the LI-7550 Outputs dialog (  ), under the **Setup** tab, choose an SDM address between 0 and 14. Address 15 is reserved for the SDMT trigger instruction.

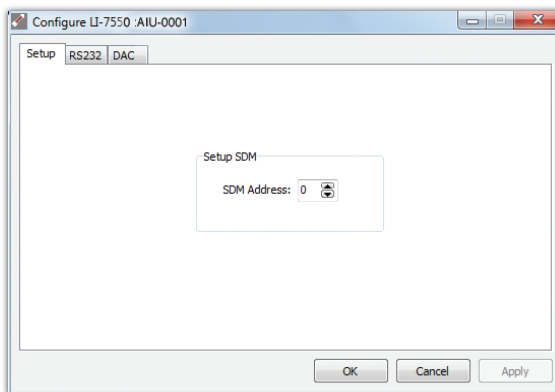

2. Set the LI-7700 output rate in the Manual Controls (  ) window. Select an output rate (e.g., 10 Hz) that is twice the desired bandwidth (e.g., 5 Hz) and click **Apply** or **OK**.

#### ***Configuring the datalogger:***

SDM communications are enabled in Campbell® Scientific dataloggers with the SDM LI7700 instruction. The basic instruction will resemble:

`LI7700 (Destination,Repetitions,SDM Address,Mode)`

Where:

`Destination` is the name of the input variable, an array, in which to store the data from the LI-7700,

`Repetitions` refers to the number of LI-7700s that will be sampled sequentially using sequential addresses,

`SDM Address` specifies the SDM address of the LI-7700 and needs to match the address set in the LI-7700 software, and

`Mode` refers to the data that will be retrieved from the LI-7700. Seven data modes are available (Table 3-4.).

An example of the instruction is given:

`LI7700 (CH4 (1) , 1 , 0 , 1)`

Where: CH4 is the destination name is for the first location in the array, 1 is the number of LI-7700s polled, 0 is the SDM Address, and 1 is “Data-Normal” from Table 3-4.

***Table 3-4. SDM Modes available in the LI-7700.***

<b>Mode</b>	<b>LI-7700 Data Sent</b>	<b>Description</b>
0	CH4D (mmol/m <sup>3</sup> )	Methane number density
Data-short	PRESSURE (kPa)	Pressure measured by the LI-7700
	TEMP (°C)	Temperature measured by the LI-7700 thermocouple
1	CH4D (mmol/m <sup>3</sup> )	Methane number density
Data-normal	PRESSURE (kPa)	Pressure measured by the LI-7700
	TEMP (°C)	Temperature measured by the LI-7700 thermocouple
	DIAG	Diagnostic value, an integer
	RSSI	Signal strength (Residual Signal Strength Indicator (0-100%))

2 Data-normal with fast auxiliaries	CH4D (mmol/m <sup>3</sup> )	Methane number density
	PRESSURE (kPa)	Pressure measured by the LI-7700
	TEMP (°C)	Temperature measured by the LI-7700 thermocouple
	DIAG	Diagnostic value, an integer
	RSSI	Signal strength (Residual Signal Strength Indicator (0-100%))
	AUX1	Auxiliary input 1
	AUX2	Auxiliary input 2
	AUX3	Auxiliary input 3
3 Data-extended	AUX4	Auxiliary input 4
	CH4D (mmol/m <sup>3</sup> )	Methane number density
	CH4 (μmol/mol)	Methane mole fraction
	PRESSURE (kPa)	Pressure measured by the LI-7700
	TEMP (°C)	Temperature measured by the LI-7700 thermocouple
	DIAG	Diagnostic value, an integer
	RSSI	Signal strength (Residual Signal Strength Indicator (0-100%))
	AUX1	Auxiliary input 1
	AUX2	Auxiliary input 2
	AUX3	Auxiliary input 3
	AUX4	Auxiliary input 4
4 Data-full	AUXTC1	Auxiliary thermocouple input 1 (°C)
	AUXTC2	Auxiliary thermocouple input 2 (°C)
	AUXTC3	Auxiliary thermocouple input 3 (°C)
	CH4D (mmol/m <sup>3</sup> )	Methane number density
	CH4 (μmol/mol)	Methane mole fraction
	PRESSURE (kPa)	Pressure measured by the LI-7700
	TEMP (°C)	Temperature measured by the LI-7700 thermocouple
	DIAG	Diagnostic value, an integer
	RSSI	Signal strength (Residual Signal Strength Indicator (0-100%))
	AUX1	Auxiliary input 1
	AUX2	Auxiliary input 2
	AUX3	Auxiliary input 3
	AUX4	Auxiliary input 4
	AUXTC1	Auxiliary thermocouple input 1 (°C)
	AUXTC2	Auxiliary thermocouple input 2 (°C)
AUXTC3	Auxiliary thermocouple input 3 (°C)	
AUX5	Auxiliary input 5	
AUX6	Auxiliary input 6	
AUX7	Auxiliary input 7	
AUX8	Auxiliary input 8	



### 3

## Operation with the LI-7550 Analyzer Interface Unit

5 Diagnostic- short	RSSI	Signal strength (Residual Signal Strength Indicator (0-100%))
	DIAG	Diagnostic value, an integer
	DROPRATE	Percentage of 1000 Hz scans dropped (0-100%)
6 Diagnostic- extended	RSSI	Signal strength (Residual Signal Strength Indicator (0-100%))
	DIAG	Diagnostic value, an integer
	HEATER	Upper and lower heater status
	DROPRATE	Percentage of 1000 Hz scans dropped (0-100%)
	OPTICSRH	Relative humidity in the upper dome (0-100%)
	LCTACTUAL	Laser cooler temperature, measured (°C)
	LCTSETPT	Laser cooler temperature, set point (°C)
7 Diagnostic- full	RSSI	Signal strength (Residual Signal Strength Indicator (0-100%))
	HEATER	Upper and lower heater status
	REFRSSI	Reference signal strength (0-100%)
	DROPRATE	Percentage of 1000 Hz scans dropped (0-100%)
	LCTACTUAL	Laser cooler temperature, measured (°C)
	LCTSETPT	Laser cooler temperature, set point (°C)
	BCTACTUAL	Block cooler temperature, measured (°C)
	BCTSETPT	Block cooler temperature, set point (°C)
	OPTICSRH	Relative humidity in the upper dome (0-100%)

## RS-232

When using RS-232 output, first set the LI-7700 output rate in the Manual Controls window (see page 2-9).

Click the **Configure LI-7550 Outputs** button (  ) for access to the outputs dialog. The **RS-232** tab is used to set the LI-7700 RS-232 port configuration for serial data output. After selecting the desired variables click **Apply**; the LI-7700 will begin to send data out the RS-232 port according to these parameters.

Since this controls a serial data stream, there is no concept of files or splitting files. The baud rate is set to 57,600. When sending data through the serial connection, note that the baud rate may limit the number of samples that can be output. Therefore, you may have better results if you do not log the Diagnostics or Status data.

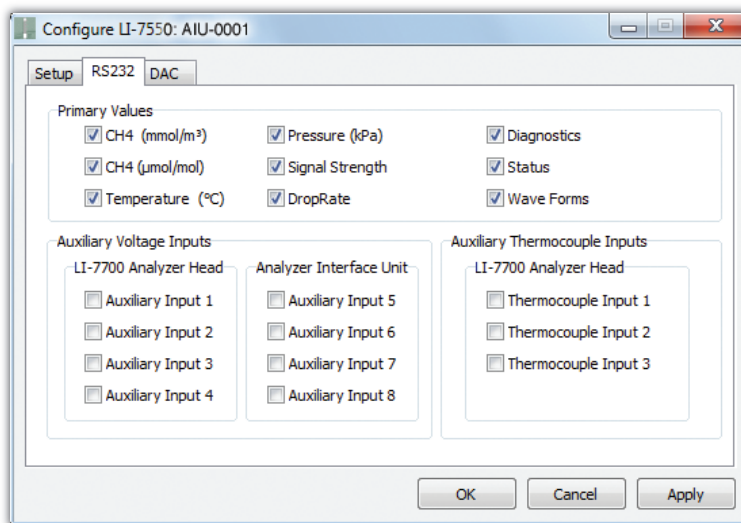

## DB-9 Pin Assignments

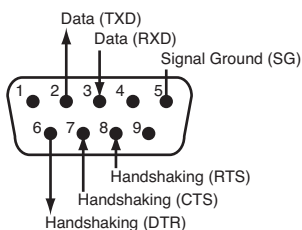

## Analog

The LI-7550 has the capacity to output up to six variables on Digital to Analog Converter (DAC) channels 1-6. Click the **Configure LI-7550 Outputs** button (  ) for access to the outputs dialog. The **DAC** tab allows you to configure the DAC output channels by specifying the source that drives the analog signal ( $\text{CH}_4$   $\text{mmol m}^{-3}$ ,  $\text{CH}_4$   $\mu\text{mol mol}^{-1}$ , temperature, pressure, signal strength, and set point), the measured value that corresponds to 0V, and the measured value that corresponds to 5V.

For example, DAC1 can be configured to output a voltage signal for  $\text{CH}_4$  with 0  $\text{mmol m}^{-1}$  proportional to 0V, and 5  $\text{mmol m}^{-1}$  equal to 5V by setting the dropdown menu to read  $\text{CH}_4$  ( $\text{mmol m}^{-1}$ ) and entering 0 and 5 in the “0V” and “5V” fields respectively.

When using the analog outputs, set the LI-7700 output rate to twice the desired bandwidth (in the Manual Controls window, see page 2-9). Configure your data storage device to sample at a rate that is equal to or greater than the LI-7700 output rate.



**Note:** The LI-7700 analog output signals update at 300 Hz to minimize jitter.

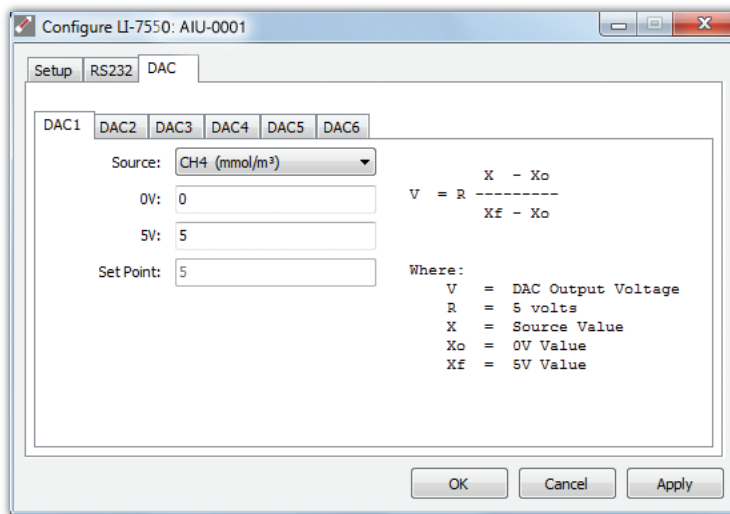

The “Set Point” field will be available when the “set point” option is selected in the **Source** drop down menu. Set point is a DC output value for testing DACs and data storage devices. The output voltage is converted via:

$$\text{Output Voltage (V)} = 5 \text{ V} * (\text{Set Point Value} - 0 \text{ V Value}) / (5 \text{ V Value} - 0 \text{ V Value})$$

### Analog Output Time Delays

The analog outputs on the LI-7550 are delayed by 1 second to account for network latencies. The total delay at a particular output rate is increased by the averaging filter according to the expression:

$$\text{Signal Delay} = 1s + \frac{\frac{40\text{Hz}}{\text{Output Rate}} - 1}{2 \times 40\text{Hz}}$$

The table below summarizes the delays:

*Table 3-5. Time delays associated with LI-7550 analog outputs.*

Output Rate	Frequency Response (-3db)	Analog Output Signal Delay
40 Hz	20 Hz	1.0 s
20 Hz	10 Hz	1.0125 s
10 Hz	5 Hz	1.0375 s
5 Hz	2.5 Hz	1.0875 s
2 Hz	1 Hz	1.2375 s
1 Hz	0.5 Hz	1.4875 s

### Analog Output Hardware Configuration (Option 3)

Both the Analog In/Out Cable (p/n 392-10109, provided) and the 7550-101 Auxiliary Sensor Interface (optional) can be used to distribute the analog output signals. Pin and terminal assignments for both are given in Table 3-6. The schematic below represents the terminal strip inside the 7550-101 when it is configured for analog outputs.

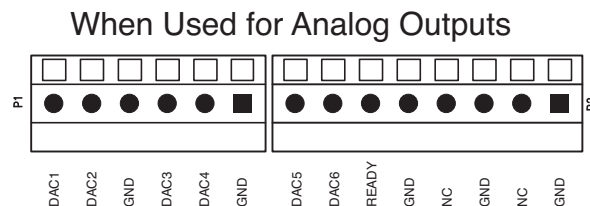

*Figure 3-9. Terminal connections for analog outputs (Option 3).*

### 3 Operation with the LI-7550 Analyzer Interface Unit

*Table 3-6. LI-7550 Analyzer Interface Unit analog outputs for the 7550-101 Auxiliary Sensor Interface and Analog In/Out Cable. 7550-101 terminals and output functions are on the left and corresponding Analog In/Out Cable wire colors and pin assignments are on the right.*

<b>Option 3<sup>b</sup></b>				
<b>7550-101 Auxiliary Sensor Interface</b>		<b>Description</b>	<b>Analog In/Out Cable (p/n 392-10109)</b>	
<b>Terminal</b>	<b>Outputs</b>		<b>Wire Color</b>	<b>Pin</b>
1	DAC1	DAC channel 1 positive	White	Pin 1
2	DAC2	DAC channel 2 positive	Brown	Pin 2
3	GND	Ground	Tan	Pin 10
4	DAC3	DAC channel 3 positive	Green	Pin 3
5	DAC4	DAC channel 4 positive	Yellow	Pin 4
6	GND	Ground	Tan	Pin 10
7	DAC5	DAC channel 5 positive	Grey	Pin 5
8	DAC6	DAC channel 6 positive	Pink	Pin 6
9	READY	Analyzer Ready	Blue	Pin 7
10	GND	Ground	Black	Pin 11
11	NC	No connection	Red	Pin 8
12	GND	Ground	Violet	Pin 12
13	NC	No connection	Orange	Pin 9
14	GND	Ground	Tan	Pin 10

<sup>b</sup> Analog Outputs 0-5V

## Mounting the LI-7550 Analyzer Interface Unit

Two brackets (p/n 6575-033) are included with the LI-7550 that can be used to mount it to a tripod or other post, using bolts or U-bolts. There are holes in the four corners of the box, as well, that can be used to attach the box directly to a flat surface.

The mounting brackets are designed to accommodate a square or circular mounting post of up to 1.25" (3.2 cm) in width (diameter). Use a 3/16" hex key to attach the mounting brackets to the Analyzer Interface Unit using 4 socket head screws (p/n 140-02654). The U-bolts can then be inserted through the holes in the mounting bracket, and tightened around the post, as shown below.

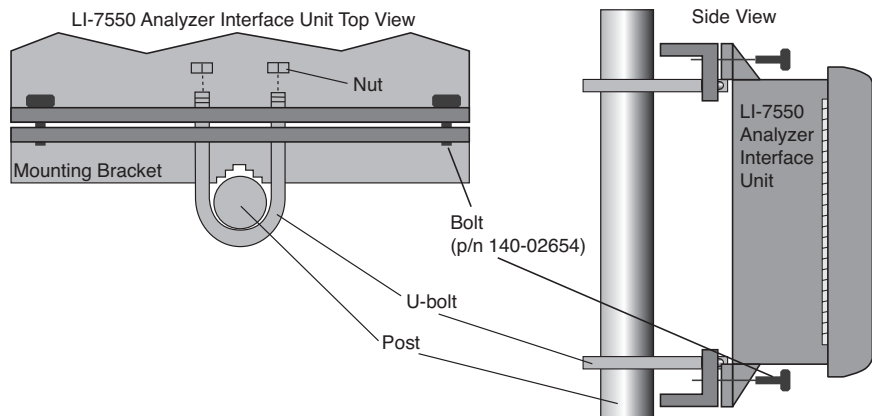

**Figure 3-10.** Attach the brackets to the Analyzer Interface Unit and secure it to the mounting post.

There are some additional considerations that should be taken into account when locating the Analyzer Interface Unit, including:

1. The data cable that connects to the sensor head is 5 meters in length; determine the height at which the sensor head will be mounted, and plan to mount the Analyzer Interface Unit accordingly. This cable could be up to several hundred feet long.
2. The thermal properties of the Analyzer Interface Unit are such that it is OK to place the box in direct sun.
3. The power cord provided is 5 meters in length. Longer cables can be purchased through distributors of Turck, Inc. (see List of Suppliers, page 8-13).
4. For lightning protection run an independent bonding wire from the instrument ground (see Figure 3-2) to the earth.

### 3 Operation with the LI-7550 Analyzer Interface Unit

The following schematic shows one potential configuration.

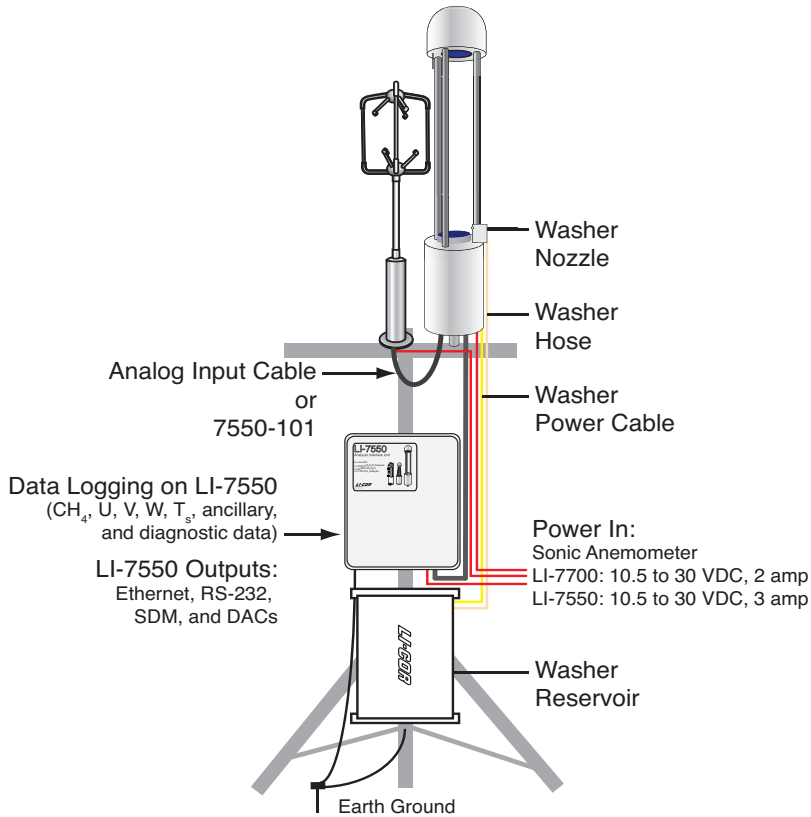

**Figure 3-11.** A typical field deployment of the LI-7700 and accessories. For eddy covariance flux applications, water vapor must also be measured. This can be accomplished with an LI-7500, LI-7500A or LI-7200 CO<sub>2</sub>/H<sub>2</sub>O Analyzer (not shown).

# 4 Data Files

When logging data to a computer or USB storage device (with the LI-7550), the LI-7700 outputs data as tab delimited text files, which can be opened in any common spreadsheet application. Each file consists of a file header, diagnostics header, data header, and data. An example data file and descriptions of the file components are shown below.

Model:	LI-7700 Open Path CH4 Analyzer						File Header
File Type:	2						
Instrument:	LI-7700-1						Diagnostics Header
Serial Number:	7700-104						
Software Version:	1.0.0						Data Header
Timestamp:	2/18/2010 14:54						
Timezone:	US/Central						Data
DATADIAGH	BOXCONNECTED	BADAUXTC3	BADAUXTC2	BADAUXTC1	MOTORFAILURE	CALIBRATING	...
DATAH	SECONDS	NANOSECONDS	DIAG	CH4	CH4D	TEMP	...
DATA	1266526458	500000000	57358	2.53497	0.103356	24.692	...
DATA	1266526459	0	57358	2.5242	0.102793	24.9592	...
DATA	1266526459	500000000	57358	2.52214	0.102688	25.0056	...
DATA	1266526460	0	57358	2.50837	0.102151	24.9534	...
DATA	1266526460	500000000	57358	2.52209	0.102707	24.9605	...
DATA	1266526461	0	57358	2.52735	0.102912	24.9788	...
DATA	1266526461	500000000	57358	2.519	0.102442	25.2609	...
...	...	...	...	...	...	...	...

## File Header

The header is part of every data file produced by the LI-7700. It includes the following fields:

*Table 4-1. Data file header.*

Header Label	Description
Model:	Analyzer
File Type:	Header content descriptor (usually 2)
Instrument:	Instrument name
Serial Number:	Instrument serial number
Software Version:	Instrument firmware version
Timestamp:	Date and time the file was created
Timezone:	Time zone setting in the instrument



## Data

The data is in columns below the DATAH row. The row above the data header includes a list of diagnostic codes that are output with each data file. This information is summarized by the value in the data field called DIAG. These values are described in the section called “Diagnostic Codes” below.

### ***Data Header***

The data header will include all the variables that are selected in the PC or USB logging window. A UTC time stamp (seconds and nanoseconds) is always output with each record in a file. Therefore, it is not necessary to output date and time unless you wish to have the local time stored with the file.

The following list of items may be visible in the data header row, depending on which values are logged:

*Table 4-2. Data header.*

Column Heading	Description
SECONDS	Seconds in UNIX time, or the time the instrument is set to
NANOSECONDS	Nanoseconds
DIAG	Diagnostic value, an integer
CH4	Methane mole fraction ( $\mu\text{mol}/\text{mol}$ )
CH4D	Methane number density ( $\text{mmol}/\text{m}^3$ )
TEMP	Temperature measured with the LI-7700 thermocouple ( $^{\circ}\text{C}$ )
PRESSURE	Pressure measured near the optical path (kPa)
RSSI	Signal strength (Residual Signal Strength Indicator, 0-100%)
DROP RATE	Percentage of 1000Hz scans that were dropped at an output rate of 40 Hz (0-100%).
AUX1	Auxiliary input 1
AUX2	Auxiliary input 2
AUX3	Auxiliary input 3
AUX4	Auxiliary input 4
AUX5	Auxiliary input 5
AUX6	Auxiliary input 6
AUX7	Auxiliary input 7
AUX8	Auxiliary input 8
AUXTC1	Auxiliary thermocouple input 1 ( $^{\circ}\text{C}$ )
AUXTC2	Auxiliary thermocouple input 2 ( $^{\circ}\text{C}$ )
AUXTC3	Auxiliary thermocouple input 3 ( $^{\circ}\text{C}$ )
DATE	Instrument date, reflects time zone setting (MM/DD/YYYY)
TIME	Instrument time, reflects time zone setting (HH:MM:SS.XXXX)
CHK	A check sum feature to check integrity of data

## Diagnostics Header

If the “Diagnostics” check box was checked in the PC, USB, or RS-232 outputs, a diagnostic header and column is included in each data file. The Diagnostics Header is a list of potential diagnostics that are output with each file. The DIAG column contains diagnostic values affiliated with each record in the file, and these values encode one or more pieces of diagnostic information. Each value is an integer between 0 and 65535, which can indicate up to 16 diagnostics. The following guide and example can help interpret this diagnostic information.

*Table 4-3. Diagnostic codes output with the LI-7700 data record.*

Diagnostics Header	Integer	Meaning
NOTREADY	32768	Instrument is not ready
NOSIGNAL	16384	No laser signal detected
REFUNLOCKED	8192	Reference methane signal not locked
BADTEMP	4096	Optical path thermocouple failure
LASERTEMPUNREGULATED	2048	Laser cooler unregulated
BLOCKTEMPUNREGULATED	1024	Block temperature unregulated
MOTORSPINNING	512	Lower mirror spin motor on
PUMPON	256	Washer pump motor running
TOPHEATERON	128	Upper mirror heater on
BOTTOMHEATERON	64	Lower mirror heater on
CALIBRATING	32	Calibration in process
MOTORFAILURE	16	Mirror cleaner motor failure
BADAUXTC1	8	Bad thermocouple values
BADAUXTC2	4	Bad thermocouple values
BADAUXTC3	2	Bad thermocouple values
BOXCONNECTED	1	LI-7550 Attached

Typically, the diagnostic field will have value of 14. This indicates that readings from the thermocouples are bad, and it will occur anytime a functioning thermocouple is not attached. The “14” is the sum of values in the “Integer” column from rows 2, 3, and 4 in the table above (2+4+8). If you are using an LI-7550, this value would be “15”.

***Interpreting a diagnostic code:***

1. Identify the integer in the DIAG column of the data file.
2. Find the largest value in the Integer column of Table 4-3 that is  $\leq$  the value from the DIAG column. The diagnosis associated with that value occurred.
3. Subtract the DIAG value from the Integer. If the difference is 0, there are no other codes. Otherwise, repeat step 2 using the difference rather than the DIAG code.
4. Repeat steps 2 and 3 until the difference equals 0.

***The following example also shows how to interpret the code:***

Say, for example, that you encounter the code 17231 associated with a series of logged values in the DIAG column.

1. Refer to Table 4-3 and locate the largest value that is  $\leq$  17231. This is 16384, which indicates that no laser signal was detected. Find the difference:  $17231 - 16384 = 847$ .
2. In Table 4-3, find the largest value that is  $\leq$  the 847. It is 512, which indicates that the lower mirror was spinning. Find the difference:  $847 - 512 = 335$ .
3. Find the largest value that is  $\leq$  335. It is 256, which indicates that the pump was running. Find the difference:  $335 - 256 = 79$ .
4. Find the largest value that is  $\leq$  79. It is 64, which indicates that the lower mirror heater was on. Find the difference:  $79 - 64 = 15$ .
5. Repeating the steps above, it is determined that three thermocouples were not attached or were dysfunctional, and the LI-7700 is connected to an LI-7550.

In summary, if there is a diagnostic value of 17231, the instrument was in the midst of a cleaning cycle while heating the lower mirror.



**Note:** Any time an odd number occurs in the DIAG field, it indicates that an LI-7550 was in use. Even numbers indicate that there was no LI-7550 attached.

## Status Columns

When logging to a USB storage device or a host PC, you can choose to log status columns to the log file, to a separate file, or not at all. Status data can also be sent through the RS-232 output. Status data are always logged at 2 Hz.



**Note:** If you choose to log status columns to the data file, status records will be interspersed with the data records by time. Only log status records if you are diagnosing the LI-7700.

### Status Header

The following header is output with the status file.

*Table 4-4. Status file header.*

Column Heading	Description
SECONDS	Seconds in UNIX time, or the time the instrument is set to
NANOSECONDS	Nanoseconds
DIAG	Diagnostic value, an integer
RSSI	Signal strength (Residual Signal Strength Indicator, 0-100%)
REFRSSI	Reference Signal Strength (0-100%)
LCTSETPT	Laser cooler temperature set point (°C)
LCTACTUAL	Laser cooler temperature measured (°C)
BCTSETPT	Block cooler temperature set point (°C)
BCTACTUAL	Block cooler temperature measured (°C)
CHASSISTEMP	Temperature in lower housing (disabled)
OPTICSTEMP	Reference junction temperature for top thermocouple (°C)
OPTICSRH	Relative humidity in the upper dome (%)
AUXREFTEMP	Temperature of Auxiliary Sensor Interface, 7550-101 (°C)
MOTORSETPT	Spin motor set point (preferred alignment)
MOTORACTUAL	Spin motor position (actual alignment)
USB	Device present
USBCAPACITY	USB device capacity
USBFREESPACE	USB device free space
REF	A diagnostic value used in technical support
GND	
OPTICSDELTA	Temperature difference between air and upper mirror
CHK	A checksum feature to check the integrity of data

# 5 Making Flux Measurements with the LI-7700

---

The LI-7700 is an open path methane analyzer. The methane densities it measures are affected by thermal expansion and dilution by water vapor in the same way as densities measured by other open path gas analyzers, such as the LI-7500A CO<sub>2</sub>/H<sub>2</sub>O Analyzer. The impacts of fluctuations in temperature and water vapor density on flux measurements were worked out by Webb, et al. (1980). Small fluctuations in pressure are usually negligible and are ignored. Webb, et al. (1980) derived equations that adjust for the effects of correlated fluctuations in temperature and water vapor, which are applied to the average raw flux over the averaging period. These are often called “WPL corrections,” attributed to the authors E. Webb, G. Pearman, and R. Leuning.

Temperature, pressure, and water vapor also impact the spectroscopic measurements made by the LI-7700 and must be taken into account. It is necessary to adjust spectroscopic light absorption measurements for correlated fluctuations in temperature and water vapor density, just as it is necessary to adjust for thermal expansion and dilution, and we use a strategy similar to the WPL corrections to apply the adjustments (patent pending). As with the WPL corrections, barometric pressure is treated as constant, and we apply the corrections over the averaging period. The spectroscopic effects of pressure, temperature and water vapor can be compensated by deriving multipliers for each of the terms in the WPL formulation. The purpose of this chapter is to show you how to apply these corrections. We derive the equations in Chapter 6.

We cannot apply these corrections to the instantaneous raw number densities because, in general, the instrument does not have access to the volume averaged instantaneous temperature or water vapor density in the optical path.



**Important:** Temperature measurements used in the methane flux calculations should always come from the sonic anemometer.

There is a small thermocouple on the LI-7700 but it should not be used for flux measurements because its frequency response varies between 1 Hz and about 10 Hz, depending upon wind speed. The thermocouple is placed on the instrument for computing slow mole fraction, not number density. Mole fraction is useful for calibration

and for estimates of mean concentration, but it should not be used for flux measurements because of limitations in frequency response.



**Important:** Water vapor flux measurements are required to compute methane fluxes with the LI-7700. These data should be acquired with an LI-7500A, LI-7500, LI-7200, or other H<sub>2</sub>O analyzer.

## Computing Fluxes



**Important:** Use the uncorrected methane number density channel (CH4D, mmol/m<sup>3</sup>) for flux measurements.

We shall use Equation 6-34 from Chapter 6, where  $q_{cm}$  is measured methane mass density before correction, so the first step is to compute mass density,  $q_{cm} = m_c \rho_c$ , where  $m_c$  is the molecular weight of methane and  $\rho_c$  is measured raw number density. Equation 6-32 can be written as

$$F_c = \mathbf{A} \left\{ \overline{w'q'_{cm}} + \mathbf{B}\mu \frac{\overline{q_{cm}}}{q_d} \overline{w'q'_v} + \mathbf{C} \left( 1 + \mu\sigma \right) \frac{\overline{q_{cm}}}{T} \overline{w'T'} \right\} \quad 5-1$$

where **A** accounts for spectroscopic effects of temperature, pressure, and water vapor on methane density, **B** provides spectroscopic corrections to the latent heat flux term for pressure and water vapor, **C** provides spectroscopic corrections to the sensible heat flux term for temperature, pressure and water vapor (Table 5-1), and other terms and factors have their usual meanings, which are defined in Table 5-2.

Spectroscopic effects of water vapor are taken into account using the concept of *equivalent pressure*,  $P_e$ . Equivalent pressure accounts for the fact that partial pressures of different gas species are not equal in their effects on pressure broadening. This concept is explained in detail in Chapter 6. For now, we note that water vapor is the only constituent of air that is both variable and present in sufficient quantities to affect pressure broadening, so  $P_e$  is computed with water vapor as the only variable gas. Thus,  $\overline{P_e} = \overline{P} \left( 1 + 0.46 \overline{x_v} \right)$ , where  $\overline{x_v}$  is the mole fraction of water vapor (see page 6-7 for details). With this introduction to  $P_e$ , the definitions of coefficients of **A**, **B**, and **C** are given in Table 5-1.

Table 5-1. Definition of variables A, B, and C.

Variable	Definition	Source
A	$A = \bar{\kappa}$ . Dimensionless. Corrects methane density for spectroscopic effects of T, P and water vapor.	Given in Table 5-3.
B	$B = 1 + (1 - 1.46\bar{x}_v)\alpha_v \bar{P}_e \frac{\kappa_{Pe}}{\kappa}$ . Dimensionless. Corrects the latent heat flux term for spectroscopic effects.	
C	$C = 1 + (1 - \bar{x}_v)\bar{T} \frac{\kappa_T}{\kappa} + \bar{x}_v(B - 1)$ . Dimensionless. Corrects the sensible heat term for spectroscopic effects.	
$\bar{x}_v$	Mole fraction of water vapor, dimensionless. $\bar{x}_v = \bar{\rho}_v / \bar{\rho} = \bar{\rho}_v R \bar{T} / \bar{P}$ .	From the LI-7500A or similar instrument, $\bar{T}$ , and $\bar{P}$ .
$\alpha_v$	Water vapor broadening factor, dimensionless. $\alpha_v = a_v - 1 = 0.46$ . $a_v$ is the foreign gas broadening coefficient for water vapor on methane, $a_v = 1.46$ .	Specific to the LI-7700. See page 6-7.
$\kappa_T$	$\kappa_T = \left. \frac{\partial \kappa}{\partial T} \right _{P_e}$ . Rate of change in $\kappa$ with $T$ at constant $P_e = \bar{P}_e$ , $K^{-1}$ .	Given in Table 5-5.
$\kappa_{Pe}$	$\kappa_{Pe} = \left. \frac{\partial \kappa}{\partial P_e} \right _{\bar{T}}$ . Rate of change in $\kappa$ with $P_e$ at constant $T = \bar{T}$ , $kPa^{-1}$ .	Given in Table 5-4.



*Table 5-2. Variables used in Equation 5-2 and to compute values for A, B, and C. Numerical values given below are used in the example calculation.*

Variable	Description	Source
$F_c = \text{mg CH}_4 \text{ m}^{-2} \text{ h}^{-1}$	correct methane flux	computed
$\overline{w'q'_{cm}} = -0.468 \text{ mg CH}_4 \text{ m}^{-2} \text{ h}^{-1}$	uncorrected methane flux	measured with the LI-7700 and sonic anemometer
$\overline{w'q'_v} = 91.04 \text{ g H}_2\text{O m}^{-2} \text{ h}^{-1}$	water vapor flux	measured with a CO <sub>2</sub> /H <sub>2</sub> O analyzer and sonic anemometer
$\overline{w'T'} = 47.63 \text{ K m h}^{-1}$	heat flux	measured in the field with a sonic anemometer
$\overline{x_v} = 0.02$	water vapor mole fraction	measured with a CO <sub>2</sub> /H <sub>2</sub> O analyzer (e.g. LI-7500A)
$\mu = 1.6077$	ratio of dry air formula weight to water vapor molecular weight	given
$\sigma = 0.0127$	ratio of water vapor mass density to dry air mass density $(=(1/\mu)\overline{x_v}/(1/\overline{x_v}))$	calculated based on $\overline{x_v} = 0.02$
$\overline{q_{cm}} = 1.227 \text{ mg CH}_4 \text{ m}^{-3}$	average mass density of methane	measured with the LI-7700
$\overline{q_d} = 1154 \text{ g m}^{-3}$	average mass density of dry air	from measured T and P
$\overline{P} = 97.7 \text{ kPa}$	average pressure	measured in the field
$\overline{P_e} = 97.7(1 + 0.46 \cdot 0.02) \approx 98.6 \text{ kPa}$	equivalent pressure	$\overline{P_e} = \overline{P}(1 + \alpha_v \overline{x_v})$
$\overline{T} = 22.25 \text{ }^\circ\text{C} = 295.38 \text{ K}$	average temperature (K)	measured in the field
$\alpha_v = 0.46$	water vapor broadening factor, dimensionless	given
$\overline{\kappa} = 0.9733$	corrects for spectroscopic effects of T, P, and $x_v$	interpolated from Table 5-3
$\kappa_{P_e} = 0.009266$	rate of change in $\kappa$ with $P_e$ at constant $T = \overline{T}$	interpolated from Table 5-4
$\kappa_T = 0.001097$	rate of change in $\kappa$ with T at constant $P_e = \overline{P_e}$	interpolated from Table 5-5

## Example Calculation

We present the example in two steps. First, we compute **A**, **B**, and **C** using the individual factors shown in Table 5-2 to illustrate the magnitudes of all the factors entering into the calculation. In a second step we show a somewhat simpler approach.

### Full Computation

In this example we calculate average CH<sub>4</sub> flux for a one-hour period over a maize field at Mead, Nebraska. This experimental site has a multi-year history of chamber measurements with very small CH<sub>4</sub> fluxes (-0.1 to 0.1 mg m<sup>-2</sup> h<sup>-1</sup> year round; Timothy J. Arkebauer, pers. comm.). Measurements were made near 11:30 am on the morning of June 06, 2009.

Using the definitions and values shown in Table 5-1 and Table 5-2, with  $\bar{\kappa}$  and the derivatives from Table 5-3, 5-4, and 5-5, we find

$$\mathbf{A} = \mathbf{0.97} ,$$

$$\mathbf{B} = \left[ 1 + \left( 1 - 1.46 \bar{x}_v \right) \alpha_v \bar{P}_e \frac{\bar{\kappa}_{Pe}}{\bar{\kappa}} \right]$$

$$\mathbf{B} = \left[ 1 + \left( 1 - 1.46 \cdot 0.02 \right) 0.46 (98.6) \frac{0.00927}{0.973} \right] = \mathbf{1.42} , \text{ and}$$

$$\mathbf{C} = \left[ 1 + \left( 1 - \bar{x}_v \right) \bar{T} \frac{\bar{\kappa}_T}{\bar{\kappa}} + \bar{x}_v (\mathbf{B} - 1) \right]$$

$$\mathbf{C} = \left[ 1 + \left( 1 - 0.02 \right) 295.38 \frac{0.001097}{0.973} \right] + 0.02 (1.4195 - 1) = 1.326 + 0.00839 = \mathbf{1.33}$$

so

$$F_c = \mathbf{0.97} \left\{ \overline{w' q'_{cm}} + \mathbf{1.42} \mu \frac{\overline{q_{cm}}}{q_d} \overline{w' q'_v} + \mathbf{1.33} (1 + \mu \sigma) \frac{\overline{q_{cm}}}{T} \overline{w' T'} \right\} . \quad \mathbf{5-2}$$

Equation 5-2 is the standard WPL equation (Equation 24 in Webb, et al., 1980) with three multipliers in bold to account for spectroscopic effects.

$$F_c = \mathbf{0.97} \left\{ -0.468 + \mathbf{1.42} \cdot 1.6077 \frac{1.227}{1154} 91.04 + \mathbf{1.33} (1 + 1.6077 \cdot 0.0127) \frac{1.227}{295.38} 47.63 \right\} = 0.021$$

The final flux, corrected for thermal expansion, water vapor dilution, and spectroscopic effects, is 0.02 mg CH<sub>4</sub> m<sup>-2</sup> h<sup>-1</sup>.

For comparison, note that the raw uncorrected flux was  $-0.468$  ( $-0.47$ )  $\text{mg CH}_4 \text{ m}^{-2} \text{ h}^{-1}$  and the flux computed according to the traditional WPL equation, but not corrected for spectroscopic effects, was  $-0.11 \text{ mg CH}_4 \text{ m}^{-2} \text{ h}^{-1}$ .

### ***Simplified Computation***

Now, as the second step, we note that the calculations can be simplified by tabulating two collections of coefficients:  $\alpha_v \bar{P}_e \frac{K_{Pe}}{K}$  and  $\bar{T} \frac{K_T}{K}$ . Table 5-6 gives a subset of values for  $\alpha_v \bar{P}_e \frac{K_{Pe}}{K}$  and Table 5-7 gives a subset of values for  $\bar{T} \frac{K_T}{K}$ . Thus,

$$\mathbf{A} = \mathbf{0.97}$$

$$\mathbf{B} = 1 + (1 - 1.46 \cdot \bar{x}_v) \alpha_v \bar{P}_e \frac{K_{Pe}}{K}, \text{ so}$$

$$\mathbf{B} = 1 + (1 - 1.46 \cdot 0.02) 0.432 = \mathbf{1.42}$$

$$\mathbf{C} = 1 + (1 - \bar{x}_v) \bar{T} \frac{K_T}{K} + \bar{x}_v (\mathbf{B} - 1), \text{ so}$$

$$\mathbf{C} = 1 + (1 - 0.02) 0.332 + 0.02(1.42 - 1) = \mathbf{1.33}$$

Using the tables with collected constants considerably simplifies the calculations and makes it easier to implement the calculations into flux computation software.

## Finding Multipliers

We present three options for acquiring values for  $\bar{\kappa}$ ,  $\alpha_v \bar{P}_e \frac{\kappa_{Pe}}{\kappa}$ , and  $\bar{T} \frac{\kappa_T}{\kappa}$ :

1. **Low Resolution Look-up Tables** (Tables 5-8, 5-9, and 5-10);
2. **Parametric Equations** (Equations 5-3, 5-4, and 5-5); or
3. **High Resolution Digital Tables** (provided with the LI-7700 software CD).

### Low Resolution Look-up Tables

Tables 5-8, 5-9, and 5-10 provide values  $\bar{\kappa}$ ,  $\alpha_v \bar{P}_e \frac{\kappa_{Pe}}{\kappa}$ , and  $\bar{T} \frac{\kappa_T}{\kappa}$  for temperatures from -30 to 50 °C in 10 °C increments, and pressures from 50 to 110 kPa in 5 kPa increments. Always compute equivalent pressure ( $\bar{P}_e = \bar{P}(1 + 0.46x_v)$ ) before entering the table, and use linear interpolation between temperature and equivalent pressure values to approximate the correct values, as shown below.

### Interpolate to find $\bar{\kappa}$

As an example, with  $\bar{P}_e = 98.6$  kPa and  $\bar{T} = 22.25$  °C, first find the value of  $\bar{\kappa}$  at 22.25 °C and 95 kPa, which is

$$0.9381 + \left[ \frac{(0.9496 - 0.9381)}{(30 - 20)} \right] (22.25 - 20) = 0.9407$$

Then find the value at 22.25 °C and 100 kPa, which is

$$0.9839 + \left[ \frac{(0.9949 - 0.9839)}{(30 - 20)} \right] (22.25 - 20) = 0.9864$$

And finally, find the value at 98.6 kPa and 22.25 °C, which is

$$\bar{\kappa} = 0.9407 + \left[ \frac{(0.9864 - 0.9407)}{(100 - 95)} \right] (98.6 - 95) = 0.97$$

*Excerpt from* Table 5-8.

	20 °C	22.25 °C	30 °C
95 kPa	0.9381	0.9407	0.9496
<b>98.6 kPa</b>		<b>0.97</b>	
100 kPa	0.9839	0.9864	0.9949

**Interpolate to find  $\alpha_v \bar{P}_e \frac{\kappa P_e}{\kappa}$**

With  $\bar{P}_e = 98.6$  kPa and  $\bar{T} = 22.25$  °C, first find the value for  $\alpha_v \bar{P}_e \frac{\kappa P_e}{\kappa}$  at 22.25 °C and pressure of 95 kPa, which is

$$0.4196 + \left[ \frac{(0.4102 - 0.4196)}{(30 - 20)} \right] (22.25 - 20) = 0.4175$$

Then find the value at 22.25 °C and 100 kPa, which is

$$0.4396 + \left[ \frac{(0.4299 - 0.4396)}{(30 - 20)} \right] (22.25 - 20) = 0.4374$$

And finally, find the value at 98.6 kPa and 22.25 °C, which is

$$\alpha_v \bar{P}_e \frac{\kappa P_e}{\kappa} = 0.4175 + \left[ \frac{(0.4175 - 0.4374)}{(95 - 100)} \right] (98.6 - 95) = 0.432$$

*Excerpt from* Table 5-9.

	20 °C	22.25 °C	30 °C
95 kPa	0.4196	0.4175	0.4102
<b>98.6 kPa</b>		<b>0.43</b>	
100 kPa	0.4396	0.4374	0.4299

**Interpolate to find  $\bar{T} \frac{K_T}{K}$**

With  $\bar{P}_e = 98.6$  kPa and  $\bar{T} = 22.25$  °C, first find the value at 22.25 °C and 95 kPa, which is

$$0.3459 + \left[ \frac{(0.3870 - 0.3459)}{(30 - 20)} \right] (22.25 - 20) = 0.3551$$

Then find the value at 22.25 °C and 100 kPa, which is

$$0.3141 + \left[ \frac{(0.3558 - 0.3141)}{(30 - 20)} \right] (22.25 - 20) = 0.3235$$

And finally, find the value at 98.6 kPa and 22.25 °C, which is

$$\bar{T} \frac{K_T}{K} = 0.3551 + \left[ \frac{(0.3551 - 0.3235)}{(95 - 100)} \right] (98.6 - 95) = 0.332$$

*Excerpt from* Table 5-10.

	20 °C	22.25 °C	30 °C
95 kPa	0.3459	0.3551	0.3870
<b>98.6 kPa</b>		<b>0.33</b>	
100 kPa	0.3141	0.3235	0.3558

### Parametric Equations

Below are formulas that can be used to approximate values for  $\bar{\kappa}$ ,  $\alpha_v \bar{P}_e \frac{K_{P_e}}{\bar{\kappa}}$ , and  $\bar{T} \frac{K_T}{\bar{\kappa}}$ .

Using the formulas, these values can be approximated with reasonably good precision. The formulas were derived empirically from high-resolution tables. They are presented in a Microsoft® Excel file on the LI-7700 Software CD. The file is called LI\_7700\_Flux\_Multipliers and the formulas are under the “Parametric Equations” tab.

### Computing $\bar{\kappa}$

To compute  $\bar{\kappa}$  as a function of temperature and pressure, first compute equivalent pressure,  $\bar{P}_e = \bar{P}(1 + 0.46x_v)$ . Then,

$$\bar{\kappa} = Q \times P_e^2 + R \times P_e + S \quad 5-3$$

where

$$Q = a_0 \times T^2 + a_1 \times T + a_2$$

$$R = b_0 \times T^2 + b_1 \times T + b_2 \quad \text{and coefficients} = \begin{array}{c|ccc} & \mathbf{0} & \mathbf{1} & \mathbf{2} \\ \hline a & 0 & -1.3 \times 10^{-7} & 3.7 \times 10^{-5} \\ b & 4.0 \times 10^{-8} & 1.1 \times 10^{-5} & 2.18 \times 10^{-3} \\ c & 2.0 \times 10^{-6} & 9.8 \times 10^{-4} & 0.378 \end{array}$$

$$S = c_0 \times T^2 + c_1 \times T + c_2$$

As an example, we compute  $\bar{\kappa}$  with  $\bar{P}_e = 98.6$  kPa and  $\bar{T} = 22.25$  °C.

$$Q = (0 \times 22.25^2) + (-1.3 \times 10^{-7} \times 22.25) + 3.7 \times 10^{-5} = 3.41 \times 10^{-5}$$

$$R = (4.0 \times 10^{-8} \times 22.25^2) + (1.1 \times 10^{-5} \times 22.25) + 2.18 \times 10^{-3} = 2.45 \times 10^{-3}$$

$$S = (2.0 \times 10^{-6} \times 22.25^2) + (9.8 \times 10^{-4} \times 22.25) + 0.378 = 0.40$$

and

$$\bar{\kappa} = (3.41 \times 10^{-5} \times 98.6^2) + (2.45 \times 10^{-3} \times 98.6) + 0.40 = 0.97$$

With this formula,  $\bar{\kappa}$  can be computed with an accuracy of better than 0.1% for pressures between 80 to 100 kPa, and temperatures between -30 to 50 °C, and with an overall accuracy of better than 0.3% for the entire range.  $T$  is temperature (°C) and  $P_e$  is equivalent pressure (kPa).



## Computing $\alpha_v \bar{P}_e \frac{\kappa P_e}{\kappa}$

To compute  $\alpha_v \bar{P}_e \frac{\kappa P_e}{\kappa}$  as a function of temperature and pressure, first compute equivalent pressure,  $\bar{P}_e = \bar{P}(1 + 0.46\bar{x}_v)$ , then

$$\alpha_v \bar{P}_e \frac{\kappa P_e}{\kappa} = (a \times T + b) \times P_e + (c \times T + d) \quad \text{5-4}$$

with coefficients:

$$a = -8.2 \times 10^{-6};$$

$$b = 4.3 \times 10^{-3};$$

$$c = -1.7 \times 10^{-4};$$

$$d = 0.03.$$

For example, we compute the value with  $\bar{P}_e = 98.6$  kPa and  $\bar{T} = 22.25$  °C.

$$\alpha_v \bar{P}_e \frac{\kappa P_e}{\kappa} = (-8.2 \times 10^{-6} \times 22.25 + 0.0043) \times 98.6 + (-1.7 \times 10^{-4} \times 22.25 + 0.030) = 0.43$$

With this formula,  $\alpha_v \bar{P}_e \frac{\kappa P_e}{\kappa}$  can be computed with an accuracy of better than 0.1% for temperatures between 0 and 50 °C and at all pressures. Overall accuracy is better than 0.3% for the entire range.  $T$  is temperature (°C) and  $P_e$  is equivalent pressure (kPa).

**Computing  $\bar{T} \frac{K_T}{\kappa}$** 

To compute  $\bar{T} \frac{K_T}{\kappa}$  as a function of temperature and pressure, first compute equivalent pressure,  $\bar{P}_e = \bar{P}(1 + 0.46\bar{x}_v)$ , then

$$\bar{T} \frac{K_T}{\kappa} = (a \times T^2 + b \times T + c) \times P_e + (d \times T^2 + e \times T + f) \quad 5-5$$

with coefficients:

$$\begin{aligned} a &= -4.0 \times 10^{-8}, \\ b &= 1.55 \times 10^{-5}, \\ c &= -7.0 \times 10^{-3}, \\ d &= -4.7 \times 10^{-6}, \\ e &= 3.0 \times 10^{-3}, \\ f &= 0.927. \end{aligned}$$

For example, we compute the value with  $\bar{P}_e = 98.6$  kPa and  $\bar{T} = 22.25$  °C.

$$\bar{T} \frac{K_T}{\kappa} = [(-4.0 \times 10^{-8} \times 22.25^2) + (1.55 \times 10^{-5} \times 22.25) + -7.0 \times 10^{-3}] \times 98.6 + (-4.7 \times 10^{-6} \times 22.25^2) + (3.0 \times 10^{-3} \times 22.25) + 0.927 = 0.33$$

With this formula,  $\bar{T} \frac{K_T}{\kappa}$  can be computed with an accuracy of better than 0.2% at pressure of 100 kPa, between -30 and 40 °C. Overall accuracy is better than 0.8% for the entire range.  $T$  is temperature (°C) and  $P_e$  is equivalent pressure (kPa).

### ***High Resolution Digital Tables***

The LI-7700 software CD includes tab delimited text files and a Microsoft® Excel file called “LI\_7700\_Flux\_Multipliers.” These files contain high-resolution tables of  $\bar{\kappa}$ ,  $\alpha_v \bar{P}_e \frac{\text{K} P_e}{\text{K}}$ , and  $\bar{T} \frac{\text{K} T}{\text{K}}$ , covering temperatures of -50 to 55 °C and pressures of 50 to 115 kPa in 1 degree and 1 kPa increments. As in the example given in Tables 5-3, 5-6, and 5-7, use linear interpolation between temperature and equivalent pressure values to acquire more accurate estimates. Compute equivalent pressure  $\bar{P}_e = \bar{P}(1 + 0.46\bar{x}_v)$  before entering the table.

In the Excel file, values for  $\bar{\kappa}$  are in the tab called “PT”, for  $\alpha_v \bar{P}_e \frac{\text{K} P_e}{\text{K}}$  are in a tab called “Pderivative”, and for  $\bar{T} \frac{\text{K} T}{\text{K}}$  are in a tab called “Tderivative.”

Values for  $\bar{\kappa}$  are also in a tab-delimited text file called “LI\_7700\_Flux\_Mult\_PT.”

Values for  $\alpha_v \bar{P}_e \frac{\text{K} P_e}{\text{K}}$  are in a tab-delimited text file called “LI\_7700\_Flux\_Mult\_Pderiv.”

Values for  $\bar{T} \frac{\text{K} T}{\text{K}}$  are in a tab-delimited text file called “LI\_7700\_Flux\_Mult\_Tderiv.”

These files can also be acquired by contacting LI-COR technical support at [envsupport@licor.com](mailto:envsupport@licor.com).

**Table 5-3. Sample calculation of the spectroscopic correction factor,  $\bar{\kappa}$ .** Values for  $\bar{\kappa}$  were computed by propagating the effects of temperature and pressure on absorption as described by Rothman, et al. (2009) through the WMS protocol and tabulating the results in 1 °C and 1 kPa increments over the range -50 to 55°C and 50 to 115 kPa (See Chapter 6 for details). This is a subset of the high-resolution table stored in the instrument and provided as a digital resource from LI-COR. The value at 22.25 °C and 98.6 kPa (equivalent pressure) was determined by linear interpolation. Compute equivalent pressure,  $\bar{P}_e = \bar{P}(1 + 0.46\bar{x}_v)$ , before entering the table.

Equivalent Pressure (kPa)	Temperature (°C)						
	20	21	22	22.25	23	24	25
96	0.94707	0.94817	0.94928		0.95040	0.95153	0.95267
97	0.95616	0.95725	0.95834		0.95945	0.96057	0.96170
98	0.96532	0.96640	0.96749	0.96776	0.96858	0.96969	0.97081
<b>98.6</b>				<b>0.97329</b>			
99	0.97456	0.97563	0.97671	0.97698	0.97779	0.97889	0.98001
100	0.98389	0.98494	0.98601		0.98709	0.98817	0.98927
101	0.99329	0.99433	0.99539		0.99645	0.99753	0.99862

**Table 5-4. Rate of change of  $\kappa$  with  $P_e$  at constant temperature,  $\kappa_{P_e} = \left. \frac{\partial \kappa}{\partial P_e} \right|_T$ .** The derivatives are computed from Table 5-3. The value at 22.25 °C and 98.6 kPa was determined by linear interpolation. Compute equivalent pressure,  $\bar{P}_e = \bar{P}(1 + 0.46\bar{x}_v)$ , before entering the table.

Equivalent Pressure (kPa)	Temperature (°C)						
	20	21	22	22.25	23	24	25
96	0.00909	0.00907	0.00906		0.00905	0.00904	0.00904
97	0.00916	0.00915	0.00914		0.00913	0.00912	0.00911
98	0.00924	0.00923	0.00922	0.0092175	0.00921	0.00920	0.00919
<b>98.6</b>				<b>0.0092655</b>			
99	0.00932	0.00931	0.00930	0.0092975	0.00929	0.00928	0.00927
100	0.00940	0.00939	0.00938		0.00937	0.00936	0.00935
101	0.00949	0.00947	0.00946		0.00945	0.00944	0.00943

## 5 Making Flux Measurements with the LI-7700

**Table 5-5. Rate of change of  $\kappa$  with temperature at constant  $P_e$ ,  $\kappa_T = \left. \frac{\partial \kappa}{\partial T} \right|_{P_e}$ .** The derivatives are computed from Table 5-3. The value at 22.25 °C and 98.6 kPa was determined by linear interpolation. Compute equivalent pressure,  $\bar{P}_e = \bar{P}(1 + 0.46\bar{x}_v)$ , before entering the table.

Equivalent Pressure (kPa)	Temperature (°C)						
	20	21	22	22.25	23	24	25
96	0.00110	0.00111	0.00112		0.00113	0.00114	0.00115
97	0.00109	0.00110	0.00111		0.00112	0.00113	0.00114
98	0.00108	0.00109	0.00110		0.00111	0.00112	0.00113
<b>98.6</b>			0.001094	<b>0.0010965</b>	0.001104		
99	0.00107	0.00108	0.00109		0.00110	0.00111	0.00112
100	0.00105	0.00107	0.00108		0.00109	0.00110	0.00111
101	0.00104	0.00106	0.00107		0.00108	0.00109	0.00110

**Table 5-6. Computed values for  $\alpha_v \bar{P}_e \frac{\kappa_{P_e}}{\kappa}$ .** Compute equivalent pressure,  $\bar{P}_e = \bar{P}(1 + 0.46\bar{x}_v)$  before entering the table.

Equivalent Pressure (kPa)	Temperature (°C)						
	20	21	22	22.25	23	24	25
96	0.4236	0.4226	0.4217		0.4207	0.4197	0.4188
97	0.4276	0.4266	0.4257		0.4247	0.4237	0.4228
98	0.4316	0.4306	0.4297		0.4287	0.4277	0.4268
<b>98.6</b>			0.4321	<b>0.4318</b>	0.4311		
99	0.4356	0.4346	0.4337		0.4327	0.4317	0.4307
100	0.4396	0.4386	0.4376		0.4367	0.4357	0.4347
101	0.4436	0.4426	0.4416		0.4406	0.4396	0.4387

*Table 5-7. Computed values for  $\bar{T} \frac{\kappa_T}{\kappa}$ . Compute equivalent pressure,  $\bar{P}_e = \bar{P}(1 + 0.46\bar{x}_v)$ , before entering the table.*

Equivalent Pressure (kPa)	Temperature (°C)						
	20	21	22	22.25	23	24	25
96	0.3395	0.3437	0.3479		0.3520	0.3561	0.3603
97	0.3332	0.3374	0.3415		0.3457	0.3498	0.3540
98	0.3268	0.3310	0.3352	0.3362	0.3394	0.3435	0.3477
<b>98.6</b>				<b>0.3324</b>			
99	0.3205	0.3247	0.3289	0.3299	0.3330	0.3372	0.3414
100	0.3141	0.3183	0.3226		0.3267	0.3309	0.3351
101	0.3078	0.3120	0.3163		0.3205	0.3247	0.3288

*Table 5-8. Values for  $\bar{\kappa}$  from -30 °C to 50 °C and 50 kPa to 110 kPa. Compute equivalent pressure,  $\bar{P}_e = \bar{P}(1 + 0.46\bar{x}_v)$ , before entering the table and interpolate between temperature and pressure values to find the value with reasonably good precision.*

Equivalent Pressure (kPa)	Temperature (°C)								
	-30	-20	-10	0	10	20	30	40	50
50	0.5450	0.5557	0.5670	0.5789	0.5914	0.6045	0.6182	0.6324	0.6472
55	0.5769	0.5872	0.5983	0.6100	0.6224	0.6354	0.6490	0.6632	0.6779
60	0.6105	0.6204	0.6311	0.6426	0.6548	0.6676	0.6811	0.6952	0.7100
65	0.6457	0.6552	0.6656	0.6768	0.6887	0.7014	0.7147	0.7287	0.7434
70	0.6828	0.6918	0.7017	0.7125	0.7242	0.7366	0.7498	0.7637	0.7782
75	0.7218	0.7302	0.7396	0.7500	0.7613	0.7734	0.7864	0.8001	0.8146
80	0.7627	0.7705	0.7793	0.7892	0.8001	0.8119	0.8246	0.8381	0.8524
85	0.8058	0.8127	0.8210	0.8303	0.8408	0.8522	0.8645	0.8778	0.8918
90	0.8510	0.8571	0.8646	0.8733	0.8832	0.8942	0.9062	0.9191	0.9329
95	0.8984	0.9036	0.9103	0.9183	0.9276	0.9381	0.9496	0.9622	0.9757
100	0.9483	0.9524	0.9581	0.9654	0.9740	0.9839	0.9949	1.0071	1.0203
105	1.0006	1.0035	1.0082	1.0146	1.0225	1.0317	1.0422	1.0539	1.0667
110	1.0554	1.0571	1.0607	1.0661	1.0731	1.0817	1.0915	1.1027	1.1151

## 5 Making Flux Measurements with the LI-7700

**Table 5-9. Values for  $\alpha_v \bar{P}_e \frac{K_{Pe}}{K}$  from -30 °C to 50 °C and 50 kPa to 110 kPa.** Values in this table can be approximated with equation 5-5. Compute equivalent pressure,  $\bar{P}_e = \bar{P}(1 + 0.46\bar{x}_v)$ , before entering the table and interpolate between temperature and pressure values to find the value with reasonably good precision.

Equivalent Pressure (kPa)	Temperature (°C)								
	-30	-20	-10	0	10	20	30	40	50
50	0.2636	0.2561	0.2491	0.2426	0.2364	0.2305	0.2250	0.2198	0.2148
55	0.2882	0.2801	0.2725	0.2654	0.2587	0.2523	0.2463	0.2407	0.2353
60	0.3125	0.3038	0.2956	0.2880	0.2807	0.2739	0.2674	0.2613	0.2555
65	0.3366	0.3273	0.3185	0.3103	0.3026	0.2953	0.2884	0.2818	0.2756
70	0.3603	0.3504	0.3412	0.3324	0.3242	0.3165	0.3091	0.3022	0.2956
75	0.3838	0.3734	0.3636	0.3544	0.3457	0.3375	0.3297	0.3223	0.3153
80	0.4071	0.3961	0.3858	0.3761	0.3669	0.3583	0.3501	0.3423	0.3349
85	0.4301	0.4186	0.4078	0.3976	0.3880	0.3789	0.3703	0.3621	0.3544
90	0.4529	0.4408	0.4295	0.4189	0.4088	0.3993	0.3903	0.3818	0.3737
95	0.4754	0.4628	0.4510	0.4399	0.4295	0.4196	0.4102	0.4013	0.3928
100	0.4977	0.4846	0.4724	0.4608	0.4499	0.4396	0.4299	0.4206	0.4118
105	0.5197	0.5062	0.4935	0.4815	0.4702	0.4595	0.4494	0.4398	0.4307
110	0.5415	0.5275	0.5144	0.5020	0.4903	0.4793	0.4688	0.4588	0.4494

**Table 5-10. Values for  $\bar{T} \frac{K_T}{K}$  from -30 °C to 50 °C and 50 kPa to 110 kPa.** Values in this table can be approximated with Equation 5-6. Compute equivalent pressure,  $\bar{P}_e = \bar{P}(1 + 0.46\bar{x}_v)$ , before entering the table and interpolate between temperature and pressure values to find the value with reasonably good precision.

Equivalent Pressure (kPa)	Temperature (°C)								
	-30	-20	-10	0	10	20	30	40	50
50	0.4602	0.5016	0.5404	0.5784	0.6151	0.6505	0.6854	0.7189	0.7527
55	0.4202	0.4625	0.5023	0.5412	0.5787	0.6150	0.6505	0.6848	0.7193
60	0.3807	0.4240	0.4647	0.5044	0.5428	0.5798	0.6162	0.6511	0.6862
65	0.3417	0.3860	0.4276	0.4682	0.5074	0.5452	0.5822	0.6178	0.6536
70	0.3033	0.3485	0.3910	0.4324	0.4724	0.5109	0.5487	0.5850	0.6214
75	0.2655	0.3116	0.3549	0.3971	0.4379	0.4771	0.5155	0.5525	0.5896
80	0.2282	0.2751	0.3193	0.3623	0.4038	0.4437	0.4828	0.5204	0.5581
85	0.1913	0.2391	0.2841	0.3279	0.3701	0.4107	0.4505	0.4887	0.5270
90	0.1550	0.2036	0.2494	0.2939	0.3368	0.3781	0.4185	0.4574	0.4962
95	0.1192	0.1686	0.2152	0.2604	0.3040	0.3459	0.3870	0.4264	0.4658
100	0.0838	0.1340	0.1813	0.2273	0.2715	0.3141	0.3558	0.3958	0.4358
105	0.0489	0.0999	0.1479	0.1945	0.2395	0.2827	0.3249	0.3655	0.4060
110	0.0145	0.0662	0.1150	0.1622	0.2078	0.2516	0.2945	0.3356	0.3766

## Zero Flux Validation

As a test of performance of the LI-7700 and the procedures described above, LI-COR deployed the LI-7700 in an agricultural field near Lincoln, NE. This research site has a year-round history of chamber-based methane measurements, which show methane flux ranging from  $-0.12$  to  $0.13 \text{ mg m}^{-2} \text{ h}^{-1}$  (Timothy J. Arkebauer, pers. comm.). Ensemble average flux measurements corrected with the standard WPL correction and for spectroscopic effects with the procedure described above, were not significantly different from zero in either winter ( $-0.11 \pm 0.19 \text{ mg m}^{-2} \text{ h}^{-1}$ , Figure 5-1) or summer ( $0.13 \pm 0.29 \text{ mg m}^{-2} \text{ h}^{-1}$ , Figure 5-2).

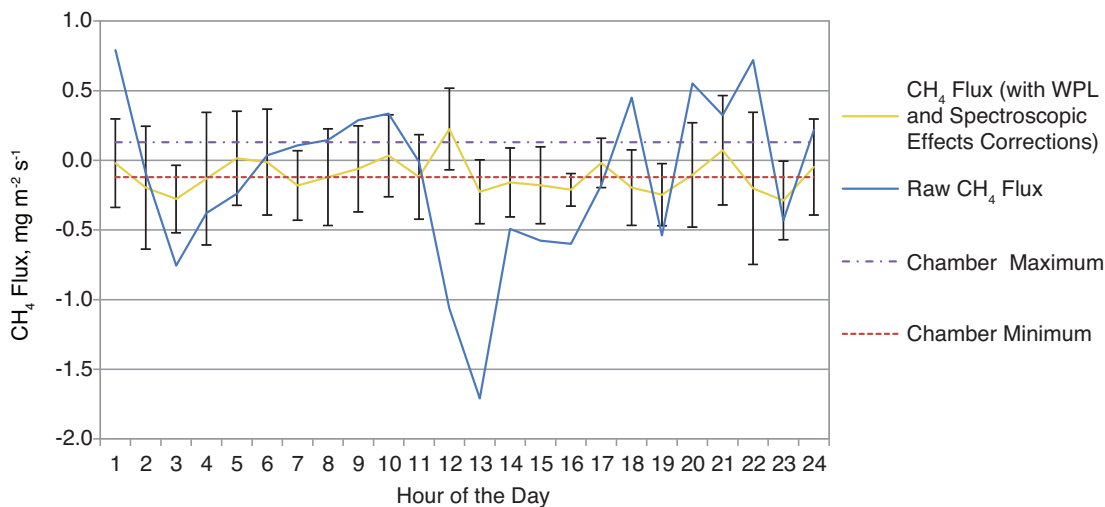

**Figure 5-1. Ensemble averaged hourly methane fluxes at a research facility near Mead, Nebraska.** Error bars show 1 standard deviation from the mean flux. These data were gathered over a partially frozen bare field in November, when temperatures ranged from  $-2$  to  $7^\circ\text{C}$ .



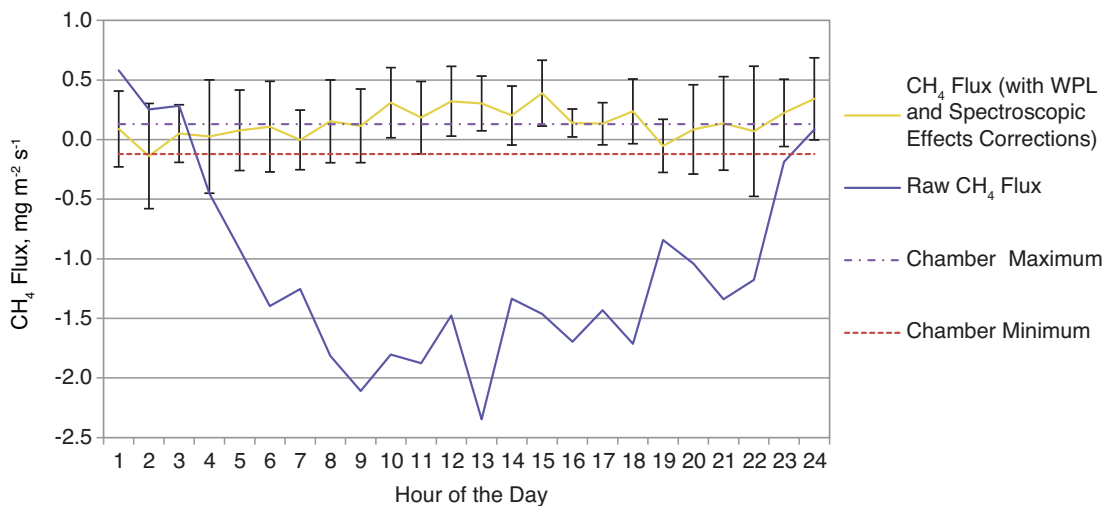

**Figure 5-2. Ensemble averaged hourly methane fluxes at a research facility near Mead, Nebraska.** Error bars show 1 standard deviation from the mean flux. These data were gathered over a maize field from June through August, when temperatures ranged from 15 to 38 °C.

## References

- Rothman L.S., I. E. Gordon, A. Barbe, D. C. Benner, P. F. Bernath, et al. 2009. The HITRAN 2008 molecular spectroscopic database. *Journal of Quantitative Spectroscopy & Radiative Transfer*, 110: 533-572.
- Webb E.K., G. Pearman, and R. Leuning. 1980. Correction of flux measurements for density effects due to heat and water vapor transfer, *Quarterly Journal of the Royal Meteorological Society*, 106: 85-100.

# 6 Theory and Equation Summary

---

## Absorption of Infrared Radiation by a Gas

The Beer-Lambert Law describes the absorption of radiation by a gas sample:

$$I = I_0 e^{-\alpha} = e^{(-S(T)g(\nu-\nu_0)Nl)} \quad 6-1$$

where  $I$  and  $I_0$  are received and incident optical power,  $\alpha$  is an absorbance,  $S(T)$  is absorption line strength as a function of temperature,  $g(\nu-\nu_0)$  is a normalized lineshape function for the line at  $\nu$ ,  $N$  is gas number density and  $l$  is the path length.

When fractional absorbance  $\Delta I/I_0$ , is small ( $<0.01$ ), linear approximation can be used:

$$\frac{I_0 - I}{I_0} = \frac{\Delta I}{I_0} \cong \alpha. \quad 6-2$$

Using Wavelength Modulation Spectroscopy (WMS), the LI-7700 laser scans across a single feature in the  $2\nu_3$  absorption band of methane near 1.6 microns with high resolution and at a high repetition rate. The wavelength is modulated at sub-MHz frequency, virtually eliminating  $1/f$  flicker noise of the laser source and allowing detection of fractional absorption less than  $10^{-5}$ , which is not attainable with conventional direct absorption. The LI-7700 demodulates the resulting signal at twice the modulation frequency, and then compares the result to a reference signal shape, which is stored in the LI-7700, to determine the  $\text{CH}_4$  concentration (the measured lineshapes are visible on Diagnostic Page1). Pressure and temperature induced changes in lineshape and population distribution, as well as changes in laser power and mirror reflectivity are compensated using computational fitting algorithms so that measurements are accurate over a wide range of pressures, temperatures, and environmental conditions.

## Temperature Dependence of Absorption Line Strength

Line strength of a particular transition is a fundamental spectroscopic property and it is proportional to the population (number of molecules) in the lower state of the transition and the absorption cross-section for that transition. The population in an individual rotational state can be calculated from Boltzmann's distribution:

$$S(T) \propto \frac{e^{-bc \frac{E_{rot}}{kT}}}{Q(T)} = \frac{N''}{N} \quad 6-3$$

where  $b$  is Planck's constant,  $c$  is the speed of light,  $k$  is Boltzmann's constant,  $N$  is total number density,  $N''$  is the number density of the probed state,  $E_{rot}$  is rotational energy of the probed state,  $Q(T)$  is the partition function. The absorption cross-section and rotational energy for a particular transition can be obtained from the HITRAN database (Rothman, et al., 2009). The partition function  $Q$  is also available as a function of temperature from HITRAN.

## Line Broadening Mechanisms

In the near infrared region, under ambient atmospheric conditions, the main sources of line broadening for CH<sub>4</sub> are Doppler broadening and pressure (collisional) broadening. For a single rotational line, the intensity profile of Doppler broadening as a function of wavelength is described by the Gaussian:

$$g_D(v; \Delta v_D) = \frac{\sqrt{\ln 2}}{\sqrt{\pi} \Delta v_D} e^{-\ln 2 \left( \frac{v-v_0}{\Delta v_D} \right)^2} \quad 6-4$$

where  $\Delta v_D$  is the Doppler half width at half maximum (HWHM) of a Gaussian profile and is:

$$\Delta v_D(T) = \sqrt{\ln 2} \frac{v_0}{c} \sqrt{\frac{2kT}{m}} \quad 6-5$$

where  $k$  is the Boltzmann constant,  $m$  is molecular mass, and  $T$  is temperature (K).

Pressure broadening is described by the Lorentzian lineshape:

$$g_L(v; \Delta v_L) = \frac{1}{\pi} \frac{\Delta v_L}{(v-v_0)^2 + (\Delta v_L)^2} \quad 6-6$$

where  $\Delta v_L$  is Lorentzian half width and can be calculated using empirically determined parameters from HITRAN database:

$$\Delta v_L(P, T) = \gamma(T_0, P_0) \left[ \frac{P}{P_0} \right] \left[ \frac{T_0}{T} \right]^r \quad 6-7$$

where  $T$  is temperature (K),  $P$  is pressure in Pa;  $\gamma(T_0, P_0)$  (pressure broadening at  $T_0$  and  $P_0$ ) and  $r$  (temperature dependence of pressure broadening) are parameters from the HITRAN database for the individual line,  $T_0=296$  K,  $P_0=101325$  Pa.

The Voigt lineshape is a convolution of the Lorentzian and Gaussian:

$$g_v(v; \Delta v_D; \Delta v_L) = \int_{-\infty}^{+\infty} g_D(v'; \Delta v_D) g_L(v - v'; \Delta v_L) dv' \quad 6-8$$

It can be rewritten in the form:

$$g_v(v) = \frac{1}{\pi \Delta v_D} \sqrt{\left( \frac{\ln 2}{\pi} \right)} \left( \frac{\Delta v_L}{\Delta v_D} \right) \sqrt{\ln 2} \int_{-\infty}^{+\infty} dt \frac{e^{-t^2}}{y^2 + (x - t)^2} \quad 6-9$$

$$\text{where } x \equiv \sqrt{\ln 2} \frac{v - v_0}{\Delta v_D} \text{ and } y \equiv \sqrt{\ln 2} \frac{\Delta v_L}{\Delta v_D}.$$

The Voigt integral has no analytic solution but can be approximated by numerical methods to a high degree of accuracy.

In summary, the population of the lower state is a function of temperature and two different mechanisms responsible for lineshape changes: Doppler broadening (a function of temperature), and pressure broadening (a function of both temperature and pressure). To calculate number density from measured absorption, knowledge of both temperature and pressure to a high degree of accuracy is absolutely essential.

## Wavelength Modulation Spectroscopy

With WMS, the wavelength of light emitted by the laser is modulated by injection current at sub-MHz frequency  $f$  while scanning across the absorption feature.

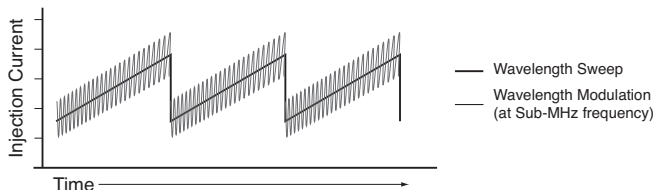

**Figure 6-1.** WMS uses wavelength sweep and modulation over a methane absorption feature to measure absorption by methane.

Wavelength modulation over the lineshape results in modulation at  $f$  and its higher harmonics ( $2f$ ,  $3f$ , etc), which are proportional to the absorption and resemble a derivative of the corresponding order. Because very strong amplitude modulation is also present at carrier frequency  $f$ , higher order harmonics are preferable for detecting a small absorption feature. The LI-7700 uses phase-sensitive demodulation by a digital lock-in amplifier at  $2f$  to obtain a background-free signal with excellent noise rejection.

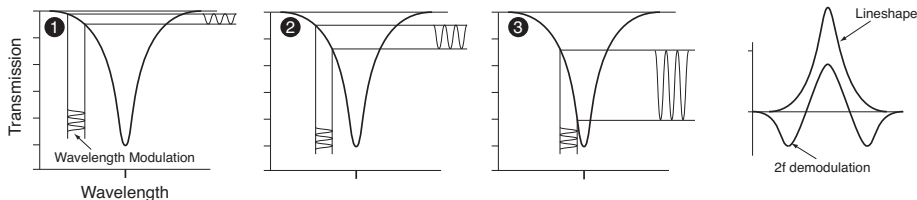

**Figure 6-2.** The wavelength is modulated and simultaneously swept across the absorption feature. Demodulation at  $2f$  results in a background free signal with low noise.

The magnitude of the waveform is linear with number density  $\rho_{cm}$  ( $=N$  from the previous discussion) and proportional to incident power  $I_0$ . The recorded waveform is compared by least squares fitting with the reference waveform (with  $P_0$ ,  $T_0$ ,  $\rho_{0cm}$  calculated using the HITRAN database and numerical computation methods for a WMS transfer function).

The sample waveform is computed from:

$$\hat{\alpha}[i] = \frac{r[i]}{I_0}$$

6-10

where  $\hat{\alpha}[i]$  is the measured lineshape,  $I_0$  is the received laser power, and  $r[i]$  is the detector output, which is also an array of  $M$  spectral samples. Number density (not corrected for temperature and pressure) is computed from:

$$\rho_{cm} = K_s \left( \sum_{i=1}^M \hat{\alpha}[i] \alpha_{ref}[i] - K_z \right) \quad 6-11$$

where  $\rho_{cm}$  is measured methane number density before correction for pressure and temperature,  $i$  is waveband 1 through  $M$ ,  $K_s$  is the span value,  $K_z$  is the zero value,  $\hat{\alpha}[i]$  is the measured lineshape, and  $\alpha_{ref}[i]$  is the reference lineshape. Number density,  $\rho_{cm}$ , as shown in Equation 6-11, is not corrected for fast temperature and pressure fluctuations. It is a standard value, which requires subsequent processing when computing fluxes with the eddy covariance method.

## Compensating for Temperature and Pressure Changes

Effects of temperature and pressure-induced changes in lineshape and population distribution, and resulting changes in WMS waveforms are pre-calculated and tabulated as a broadening compensation function,  $\kappa(T,P)$ .  $\kappa(T,P)$  is stored in the instrument as a look-up table and is shown in Figure 6-3. When precise temperature and pressure measurements are available, they can be implemented as:

$$\rho_c = \rho_{cm} \times \kappa(T,P) \quad 6-12$$

where  $\rho_{cm}$  is the measured methane number density before correction,  $T$  is temperature ( $^{\circ}\text{C}$ ), and  $P$  is atmospheric pressure (kPa). Atmospheric pressure and air temperature are measured by the LI-7700 using an on-board pressure sensor and thermocouple, and are output with the data stream; however, because the LI-7700 temperature measurements are relatively slow,  $\kappa(T,P)$  is not applied to the  $\text{CH}_4$  number density channel ( $\text{mmol m}^{-3}$ ).

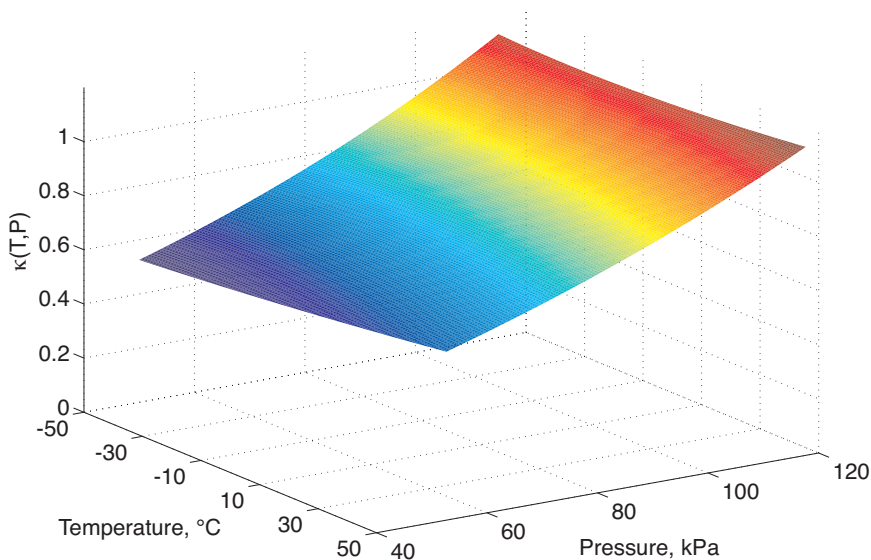

**Figure 6-3. 3-D plot of  $\kappa(T,P)$ .**

The impact of broadening on flux calculations is accounted for in a manner similar to that used by Webb, et al., (1980) for thermal expansion and water vapor dilution, using temperature and windspeed measured by the sonic anemometer and water vapor measured with an LI-7500A Open Path CO<sub>2</sub>/H<sub>2</sub>O Analyzer, or similar instrument. This will be described in the next section.

On-board measurements of temperature and pressure are used to compute methane mole fraction ( $\mu\text{mol mol}^{-1}$ ,  $x_c$ ):

$$x_c = \frac{\rho_{cm}RT}{P} \times \kappa(T,P) \tag{6-13}$$

where  $R$  is the gas constant ( $8.314 \text{ J K}^{-1} \text{ mol}^{-1}$ ).  $x_c$  is suitable for calibration, diagnostics, and atmospheric monitoring, when slow changes in temperature are expected. The mole fraction output is fully corrected for temperatures and pressures measured with on-board sensors, but it is not suitable for flux measurements because the response time of the thermocouple is relatively slow (roughly 1 Hz cutoff frequency). The thermocouple is designed to provide accurate and robust temperature measurements, not fast temperature measurements.

As described in the previous section, only the  $\rho_{cm}$  channel (methane density,  $\text{mmol m}^{-3}$ ), which is uncorrected for  $T$  and  $P$ , should be used for flux measurements. Temperature and

pressure corrections are then applied over each averaging interval (e.g., half hour) using the modified WPL procedure presented in Chapter 5.

### Compensating for Water Vapor: Equivalent Pressure, $P_e$

Different gases are not equally effective in causing pressure broadening of absorption lines. The effects of pressure broadening by different diluent gases, including water vapor, can be represented with a single quantity called equivalent pressure,  $P_e$  (kPa) (Burch, et al., 1962). Equivalent pressure can be defined as  $P_e = p_{N_2} + \sum a_i p_i$ , where  $p_{N_2}$  is the partial pressure of nitrogen, and  $p_i$  gives the partial pressures of other diluent non-absorbing gases, each multiplied by its foreign gas coefficient  $a_i$ . The coefficients  $a_i$  reflect the ability of each diluent gas to cause pressure broadening relative to broadening caused by  $N_2$ . Self-broadening by methane on methane is neglected because its concentration is so low.

Methane measurements are made in air where water vapor is the only variable component in sufficient concentration to affect broadening. Therefore, we define  $P_e$  relative to dry air instead of nitrogen, so we have  $P_e = p_d + a_v p_v$ , where  $p_d$  is partial pressure of dry air (kPa),  $a_v$  is the foreign gas broadening coefficient for water vapor relative to dry air, and  $p_v$  is water vapor partial pressure (kPa). Total air pressure  $P$  can be written as  $P = p_d + p_v$ . Subtracting  $P$  from  $P_e$  and rearranging gives

$$P_e = P(1 + \alpha_v x_v) \quad 6-14$$

where  $\alpha_v = a_v - 1$ , and  $x_v = p_v / P$  is water vapor mole fraction. For the LI-7700,  $a_v$  is found experimentally to have a value of 1.46 (Figure 6-4), but this value may vary for other instruments depending upon the gas species, the absorption line or lines being measured, and the instrument design.



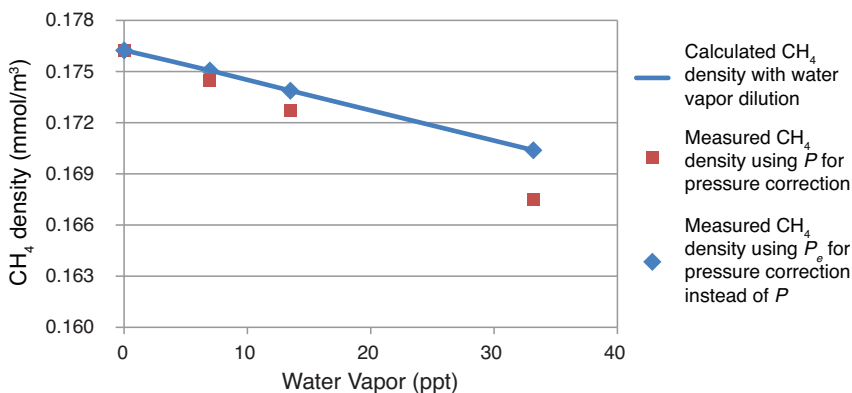

**Figure 6-4. Calculated water vapor dilution effects and actual response of the LI-7700 at 0.176 mmol/m<sup>3</sup> CH<sub>4</sub>, P of 97.7 kPa, and T of 42.8 °C.** Blue line: Expected theoretical methane density based upon dilution. Red squares: Measured  $\rho_{\text{cm}}$  based upon barometric pressure and temperature. Methane density is increasingly under-estimated as water vapor mole fraction increases. Blue diamonds: Measured  $\rho_{\text{cm}}$  using  $P_e$  computed from the water vapor mole fraction at each point instead of  $P$  in  $\kappa(T, P_e)$ . The water broadening coefficient used here is specific to the LI-7700 but is consistent with water vapor broadening parameters extrapolated from Gharavi and Buckley (2005) over much higher temperatures and water vapor mole densities.

Using the Ideal Gas Law,  $P_e$  also can be re-written as

$$P_e = P + \alpha_v RT \rho_v \tag{6-15}$$

where  $\rho_v = p_v(RT)^{-1}$  is water vapor number density (mol m<sup>-3</sup>). Now we can view the effects of water vapor as a perturbation on the total pressure, so  $\kappa(T, P)$  shown in Figure 6-1 can be generalized as  $\kappa(T, P_e)$ , which includes pressure broadening by water vapor using Equation 6-14 or 6-15.

For slow measurements, it follows that to correct methane density for pressure broadening due to water vapor, simply use  $P_e$  as defined in Equations 6-14 or 6-15, instead of  $P$  when entering the table for  $\kappa(T, P)$  in Equation 6-12. For methane mole fraction,  $x_c$ , a pressure correction has already been applied by the instrument based upon the measured  $P$  according to Equation 6-13, so to correct for water vapor, simply multiply  $x_c$  by  $\kappa(T, P_e)/\kappa(T, P)$ .

We now have the tools to examine how the spectroscopic effects of  $T$ ,  $P$ , and water vapor will propagate into methane flux measurements.

## Derivation of Multipliers for Flux Measurements

The instantaneous concentration of methane in the turbulent atmosphere above a surface is affected by the exchange of methane, heat, and water vapor with the surface. When the instantaneous methane concentration is measured with an open path instrument it is necessary to know the instantaneous temperature and water vapor concentration in order to correct for thermal expansion and dilution. Webb, et al., (1980) showed how corrections for such effects could be made using statistical parameters measured over an appropriate averaging period (e.g., 30 minutes). Similarly, it is also necessary to correct for the spectroscopic effects of fluctuations in temperature and water vapor, because even though these effects are small, they are highly correlated with the methane transport we wish to measure. In the derivation that follows we show that spectroscopic effects can be treated in a manner similar to thermal expansion and dilution (patent pending), and can be combined with the formulation proposed by Webb, et al., (1980).

Pressure-related fluctuations are usually neglected, but it may be necessary to pay attention to this if the research site is at a high elevation. This can be done as part of the WPL correction using a third pressure term (Massman & Tuovinen, 2006). The derivation that follows can be extended to include spectroscopic effects of pressure fluctuations if such are needed. We are neglecting them here.

Before beginning we note once again that only the uncorrected methane density ( $\text{mmol m}^{-3}$ ) should be used for flux calculations. Mean  $\text{CH}_4$  mole fraction ( $\mu\text{mol mol}^{-1}$ ) reported by the LI-7700 is compensated for pressure in real time and for temperature using a relatively slow thermocouple, but not water vapor, so it is not suitable for flux calculations. The methane mole fraction output can be used for calibration and diagnostic purposes but we do not recommend its use for flux calculations.

We begin by defining  $\kappa(T, P_e)$  as before, and

$$\rho_e = \rho_{cm} \kappa \tag{6-16}$$

where  $\rho_{cm}$  is measured gas density ( $\text{mol m}^{-3}$ ) not corrected for  $T$  and  $P$  effects,  $\rho_e$  is the actual density of the sample ( $\text{mol m}^{-3}$ ), and  $\kappa$  is the broadening compensation function using  $P_e$  rather than  $P$ . Using Reynolds decomposition, each term can be written:

$$\rho_e = \overline{\rho_e} + \rho'_e \tag{6-17}$$

$$\rho_{cm} = \overline{\rho_{cm}} + \rho'_{cm} \tag{6-18}$$

$$\kappa = \overline{\kappa} + \kappa' \tag{6-19}$$

Mean quantities are indicated by the over-bars. The deviation of an instantaneous quantity from the mean is indicated by a prime. The instantaneous quantity is indicated by the absence of over-bar or prime. Instantaneous deviations in  $\kappa$  due to fluctuations in temperature and water vapor density from their means can be described by a Taylor series expansion:

$$\kappa = \bar{\kappa}(\bar{T}, \bar{P}_e) + \left. \frac{\partial \kappa(\bar{T}, \bar{P}_e)}{\partial T} \right|_{\bar{P}_e} \delta T + \left. \frac{\partial \kappa(\bar{T}, \bar{P}_e)}{\partial P_e} \right|_{\bar{T}} \delta P_e + \dots \quad 6-20$$

The terms  $\delta T$  and  $\delta P_e$  represent small deviations and can be denoted as  $T'$  and  $P_e'$ , respectively. Also, we denote  $\kappa_T = \left. \frac{\partial \kappa(\bar{T}, \bar{P}_e)}{\partial T} \right|_{\bar{P}_e}$  and  $\kappa_{P_e} = \left. \frac{\partial \kappa(\bar{T}, \bar{P}_e)}{\partial P_e} \right|_{\bar{T}}$ , giving

$$\kappa \approx \bar{\kappa} + \kappa_T T' + \kappa_{P_e} P_e' \quad 6-21$$

where higher order terms are neglected. Expanding Equation 6-16 with Equations 6-17, 6-18 and 6-21 leads to:

$$\bar{\rho}_c + \rho'_c = (\bar{\rho}_{cm} + \rho'_{cm}) (\bar{\kappa} + \kappa_T T' + \kappa_{P_e} P_e') \quad 6-22$$

$$\bar{\rho}_c + \rho'_c = \bar{\kappa} \bar{\rho}_{cm} + \kappa_T \bar{\rho}_{cm} T' + \kappa_{P_e} \bar{\rho}_{cm} P_e' + \bar{\kappa} \rho'_{cm} + \kappa_T T' \rho'_{cm} + \kappa_{P_e} P_e' \rho'_{cm} \quad 6-23$$

From Equation 6-16 and with  $\bar{\rho}_c = \bar{\kappa} \bar{\rho}_{cm}$ , the first terms on the left side and right side of Equation 6-23 cancel. Multiplying by  $w'$ , time averaging, and noting that triple prime terms are small compared to double prime terms, yields

$$\overline{w' \rho'_c} = \bar{\kappa} \overline{w' \rho'_{cm}} + \kappa_T \overline{\rho_{cm} w' T'} + \kappa_{P_e} \overline{\rho_{cm} w' P_e'} \quad 6-24$$

where  $(\overline{w' \rho'_c})$  is the raw flux in  $\text{mol m}^{-2} \text{s}^{-1}$ .

$P_e'$  can be re-written in terms of water vapor density  $\rho_v'$  using Equation 6-15; thus,

$$\delta P_e = \delta P + \alpha_v R \bar{T} \delta \rho_v + \alpha_v R \bar{\rho}_v \delta T. \text{ If barometric pressure } P \text{ were considered to vary its effect would enter the derivation here; but at constant } P, \text{ and substituting primes for deltas, } P_e' = \alpha_v R \bar{T} \rho_v' + \alpha_v R \bar{\rho}_v T' \quad 6-25$$

and

$$\overline{w' \rho'_c} = \bar{\kappa} \overline{w' \rho'_{cm}} + \kappa_T \overline{\rho_{cm} w' T'} + \kappa_{P_e} \overline{\rho_{cm} (\alpha_v R \bar{T} w' \rho_v' + \alpha_v R \bar{\rho}_v w' T')}. \quad 6-26$$

Substituting  $R\bar{T} = \frac{\bar{P}}{\rho} = \frac{\bar{P}_d}{\rho_d} = \frac{\bar{P}}{\rho_d} (1 - x_v)$

gives

$$\overline{w' \rho'_c} = \overline{\kappa w' \rho'_{cm}} + \overline{\rho_{cm}} (\kappa_T + \kappa_{Pe} \alpha_v R \overline{\rho_v}) \overline{w' T'} + \kappa_{Pe} (1 - x_v) \frac{\overline{\rho_{cm}}}{\rho_d} \alpha_v \overline{P w' \rho'_v} \quad 6-27$$

where  $\overline{\rho_d}$  is the number density of dry air ( $\text{mol m}^{-3}$ ).

With a small change in notation, Equation 24 of Webb et al. (1980) can be rewritten as:

$$F_c = \overline{w' q'_c} + \mu \frac{\overline{q_c}}{q_d} \overline{w' q'_v} + (1 + \mu \sigma) \frac{\overline{q_c}}{T} \overline{w' T'} \quad 6-28$$

where  $F_c$  is mass flux of non-reactive gas ( $\text{g m}^{-2} \text{s}^{-1}$ ),  $q_i = m_i \rho_i$  is mass density ( $\text{g m}^{-3}$ ) of a non-reactive gas (methane, dry air, or water vapor denoted by subscripts  $c$ ,  $d$ , or  $v$  respectively),  $\mu = m_d / m_v$  is a ratio of the formula weight of dry air to the molecular weight of water vapor, and  $\sigma = \overline{q_v} / q_d$ .

Equation 6-27 can be rewritten in terms of mass flux by multiplying each term on both sides by the molecular weight of nonreactive gas ( $m_c$ ) and by changing variables in the last

term on the right by noting that  $\frac{\overline{w' \rho'_v}}{\rho_d} = \frac{\overline{w' q'_v}}{q_d} \mu$  to give

$$\overline{w' q'_c} = \overline{\kappa w' q'_{cm}} + (\kappa_T + \kappa_{Pe} \alpha_v R \overline{\rho_v}) \overline{q_{cm}} \overline{w' T'} + \kappa_{Pe} \mu (1 - x_v) \frac{\overline{q_{cm}}}{q_d} \alpha_v \overline{P w' q'_v}. \quad 6-29$$

Substituting 6-29 into 6-28 and noting that  $\overline{q_c} = \overline{q_{cm}}\overline{\kappa}$ ,

$$F_c = \overline{\kappa w' q'_{cm}} + (\kappa_T + \kappa_{Pe} \alpha_v R \overline{\rho_v}) \overline{q_{cm} w' T'} + \kappa_{Pe} \mu (1 - \overline{x_v}) \frac{\overline{q_{cm}}}{q_d} \alpha_v \overline{P w' q'_v} + \overline{\kappa} \mu \frac{\overline{q_{cm}}}{q_d} \overline{w' q'_v} + \overline{\kappa} (1 + \mu \sigma) \frac{\overline{q_{cm}}}{T} \overline{w' T'}. \quad 6-30$$

We now wish to rearrange Equation 6-30 to put it into a form similar to Equation 6-28.

To do that, we note  $1 + \mu \sigma = 1 / (1 - \overline{x_v})$ , and multiplying the second term on the right by

$$(1 + \sigma \mu)(1 - \overline{x_v}) = 1 \text{ gives}$$

$$F_c = \overline{\kappa w' q'_{cm}} + (1 - \overline{x_v})(1 + \sigma \mu) (\kappa_T + \kappa_{Pe} \alpha_v R \overline{\rho_v}) \overline{q_{cm} w' T'} + \kappa_{Pe} \mu (1 - \overline{x_v}) \frac{\overline{q_{cm}}}{q_d} \alpha_v \overline{P w' q'_v} + \overline{\kappa} \mu \frac{\overline{q_{cm}}}{q_d} \overline{w' q'_v} + \overline{\kappa} (1 + \mu \sigma) \frac{\overline{q_{cm}}}{T} \overline{w' T'}. \quad 6-31$$

Collecting like terms in  $\overline{w' q'_v}$  and  $\overline{w' T'}$  and factoring yields

$$F_c = \overline{\kappa w' q'_{cm}} + \overline{\kappa} \mu \frac{\overline{q_{cm}}}{q_d} \overline{w' q'_v} + (1 - \overline{x_v}) \alpha_v \overline{P} \kappa_{Pe} \mu \frac{\overline{q_{cm}}}{q_d} \overline{w' q'_v} + \overline{\kappa} (1 + \mu \sigma) \frac{\overline{q_{cm}}}{T} \overline{w' T'} + (1 - \overline{x_v}) \overline{T} (\kappa_T + \kappa_{Pe} \alpha_v R \overline{\rho_v}) (1 + \mu \sigma) \frac{\overline{q_{cm}}}{T} \overline{w' T'}$$

or,

$$F_c = \overline{\kappa} \left\{ \overline{w' q'_{cm}} + \left[ 1 + (1 - \overline{x_v}) \alpha_v \overline{P} \frac{\kappa_{Pe}}{\overline{\kappa}} \right] \mu \frac{\overline{q_{cm}}}{q_d} \overline{w' q'_v} + \left[ 1 + (1 - \overline{x_v}) \overline{T} \frac{(\kappa_T + \kappa_{Pe} \alpha_v R \overline{\rho_v})}{\overline{\kappa}} \right] (1 + \mu \sigma) \frac{\overline{q_{cm}}}{T} \overline{w' T'} \right\}. \quad 6-32$$

Now we note that  $R \overline{\rho_v} = \overline{P x_v} / \overline{T}$ , so

$$F_c = \overline{\kappa} \left\{ \overline{w' q'_{cm}} + \left[ 1 + (1 - \overline{x_v}) \alpha_v \overline{P} \frac{\kappa_{Pe}}{\overline{\kappa}} \right] \mu \frac{\overline{q_{cm}}}{q_d} \overline{w' q'_v} + \left[ 1 + (1 - \overline{x_v}) \overline{T} \frac{\kappa_T}{\overline{\kappa}} + \overline{x_v} (1 - \overline{x_v}) \alpha_v \overline{P} \frac{\kappa_{Pe}}{\overline{\kappa}} \right] (1 + \mu \sigma) \frac{\overline{q_{cm}}}{T} \overline{w' T'} \right\} \quad 6-33$$

where  $\left[ 1 + (1 - \overline{x_v}) \alpha_v \overline{P} \frac{\kappa_{Pe}}{\overline{\kappa}} \right]$  is the latent heat multiplier and

$\left[ 1 + (1 - \overline{x_v}) \overline{T} \frac{\kappa_T}{\overline{\kappa}} + \overline{x_v} (1 - \overline{x_v}) \alpha_v \overline{P} \frac{\kappa_{Pe}}{\overline{\kappa}} \right]$  is the sensible heat multiplier. Both multipliers

involve the term  $(1 - \overline{x_v}) \alpha_v \overline{P} \frac{\kappa_{Pe}}{\overline{\kappa}}$ .

We need to write Equation 6-33 in terms of  $P_e$  so we can build a table that involves only  $P_e$  instead of both  $\bar{P}$  and  $P_e$ . From Equation 6-14,  $\bar{P} = \bar{P}_e / (1 + \alpha_v \bar{x}_v)$ ;  $\alpha_v = 0.46$ , and for dew points below 32 °C at one atmosphere,  $\bar{x}_v$  is always less than 0.05, so to a good approximation,  $(1 - \bar{x}_v) / (1 + 0.46 \bar{x}_v) \approx 1 - 1.46 \bar{x}_v$ . The error in this expression is less than 0.2% for dew points below 32 °C and one atmosphere, and much less for more moderate dew points. Thus, Equation 6-33 becomes

$$F_c = \mathbf{A} \left\{ \overline{w'q'_{cm}} + \mathbf{B} \mu \frac{\overline{q_{cm}}}{q_d} \overline{w'q'_v} + \mathbf{C} (1 + \mu \sigma) \frac{\overline{q_{cm}}}{\bar{T}} \overline{w'T'} \right\}. \quad 6-34$$

$$\mathbf{A} = \bar{\kappa}$$

$$\mathbf{B} = \left[ 1 + (1 - 1.46 \bar{x}_v) \alpha_v \bar{P}_e \frac{\bar{\kappa} P_e}{\bar{\kappa}} \right]$$

$$\mathbf{C} = \left[ 1 + (1 - \bar{x}_v) \bar{T} \frac{\bar{\kappa} T}{\bar{\kappa}} + \bar{x}_v (\mathbf{B} - 1) \right]$$

Equation 6-34 is now in a form similar to Equation 24 of Webb et al. (1980), except that the latent heat flux term is multiplied by a spectroscopic correction factor dominated by water vapor and the sensible heat flux term is multiplied by a spectroscopic correction factor dominated by temperature. It should be noted, however, that temperature, pressure, and water vapor mole fraction all enter into both terms because they all are used to determine the entry point in the correction tables summarized by the response surface of  $\kappa$  shown in Figure 6-1. Tables are provided in Chapter 5 giving  $\kappa$ , its derivatives, and the factors  $\bar{T} \frac{\bar{\kappa} T}{\bar{\kappa}}$  and  $\alpha_v \bar{P}_e \frac{\bar{\kappa} P_e}{\bar{\kappa}}$ .

For typical conditions at or near sea level, and for a wide range of air temperatures and humidities, the first multiplier,  $\mathbf{A}$ , ranges between 0.93 and 1.02; the second multiplier,  $\mathbf{B}$ , ranges between 1.40 and 1.45; and the third multiplier,  $\mathbf{C}$ , ranges from 1.10 to 1.45. Step-by-step instructions are given in Chapter 5 for applying these corrections. Software utilities and digital copies of the tables are also available from LI-COR.

The last term in multiplier  $\mathbf{C}$  is multiplied by the mole fraction of water vapor, which is often near 0.02. This causes the third term in  $\mathbf{C}$  to be small when compared to the first two terms. Thus, one may choose to neglect the third term in  $\mathbf{C}$ , which introduces about a 1% error in  $\mathbf{C}$  but simplifies the calculation somewhat.  $\mathbf{C}$  itself should not be neglected. The sample calculation given in Chapter 5 shows the magnitude of the term to be about 0.008

for that example. The third term in **C** derives from the change of variables when we expressed  $P_c$  in terms of water vapor number density instead of mole fraction. The total derivative of Equation 6-26 then involved a temperature derivative as well as a vapor density derivative, which leads to the third term in **C**.

## References

- Burch, D.E., and D. Williams. 1964. Test of theoretical band model approximations. *Applied Optics*, 3: 55-61.
- Gharavi, M., and S. G. Buckley. 2005. Diode laser absorption spectroscopy measurement of line strengths and pressure broadening coefficients of the methane  $2\nu_3$  band at elevated temperatures. *Journal of Molecular Spectroscopy*, 229: 78-88.
- Massman, W. J. and J. P. Touvinen. 2006. An analysis and implications of alternative methods of deriving the density (WPL) terms for eddy covariance measurements. *Boundary Layer Meteorology*, 121: 221-227.
- Webb E.K., G. Pearman, and R. Leuning. 1980. Correction of flux measurements for density effects due to heat and water vapor transfer, *Quarterly Journal of the Royal Meteorological Society*, 106: 85-100.

# 7 Advanced Operation

---

This section describes a variety of maintenance and diagnostic procedures, including zero and span calibrations, laser temperature controls, line locking, and communications grammar.

## Calibration

The implementation of the zero and span into calculations is given in Equation 6-11 on page 6-5. The overall accuracy of the LI-7700 depends upon its calibration. Always use quality zero and span gases in a balance of air with CH<sub>4</sub> accuracy greater than 1%. Use gases that are free of Volatile Organic Compounds (VOCs) other than methane. See the list of suppliers (page 8-12) for more information. LI-COR recommends that you check the readings every 6 months.

### *Performing a Zero Calibration*

To zero the LI-7700:

1. Connect the LI-7700 to a power supply and a computer. Launch the LI-7700 software and connect with the instrument.
2. Remove the radiation shield and install the calibration shroud. Ensure that it seals around the top and bottom openings.
3. Connect the “zero gas” (0 ppm CH<sub>4</sub> in air) to the shroud fittings.
4. Flow the gas through the shroud. Allow from 10 to 30 minutes for equilibration, depending on flow rate.
5. Click the **Zero CH<sub>4</sub>** button in the calibration frame. When the instrument begins the zero operation, the panel will update to reflect the activity. The **Zero CH<sub>4</sub>** will change to “Abort.” Clicking **Abort** terminates the zero procedure. It usually takes about 10 seconds to zero. If it takes significantly longer, check for leaks and verify the calibration tank pressure.
6. After the software completes the zero operation choose either to apply the new calibration value or revert to the previous calibration value.

If the application is closed or if the LI-7700 is powered off before a confirmation command is received the new calibration will not be applied.



### ***Performing a Span Calibration***

Performing a span is essentially the same as a zero, except that you must flow the span gas through the optical path and enter the span gas concentration in parts per million (ppm). Select a span gas with a methane concentration at or slightly above the methane concentrations you expect to measure. For measurement of methane in ambient air, 2 ppm methane in a balance of air is ideal.

Following the completion of the “Zero Calibration” above,

1. Connect the “span gas” (~2 ppm CH<sub>4</sub> in air) to the shroud fittings.
2. Type the concentration (ppm) of the span gas into the field on the calibration pane.
3. Flow the gas through the shroud. Allow from 10 to 30 minutes for equilibration, depending on flow rate.
4. Click the **Span CH<sub>4</sub>** button in the calibration frame. When the instrument begins the zero operation, the panel will update to reflect the activity. The **Span CH<sub>4</sub>** will change to “Abort.” Clicking **Abort** terminates the zero procedure. It usually takes about 10 seconds to zero. If it takes significantly longer, check for leaks and verify the calibration tank pressure.
5. After the software completes the zero operation choose either to apply the new calibration value or revert to the previous calibration value.

### ***Factory Reset***

The **Factory Reset** button in the main view will restore the original factory zero and span settings. Use this only if you attempt to set the zero and span, but are unable to complete the procedure for some reason or another, or if you complete an attempted calibration, but prefer to use the factory zero and span settings.

## Diagnostics

### Laser Temperature Control

During normal operation, the instrument uses an automatic control loop to maintain the laser temperature, which in turn keeps the laser wavelength tuned to the absorbance feature of interest. In the LI-7700, the laser scans a sealed vessel of methane along with the open path cavity. The results of the cavity scan (reference) and optical path scan (sample) are displayed as a waveform on the Diagnostics Page of the Main View:

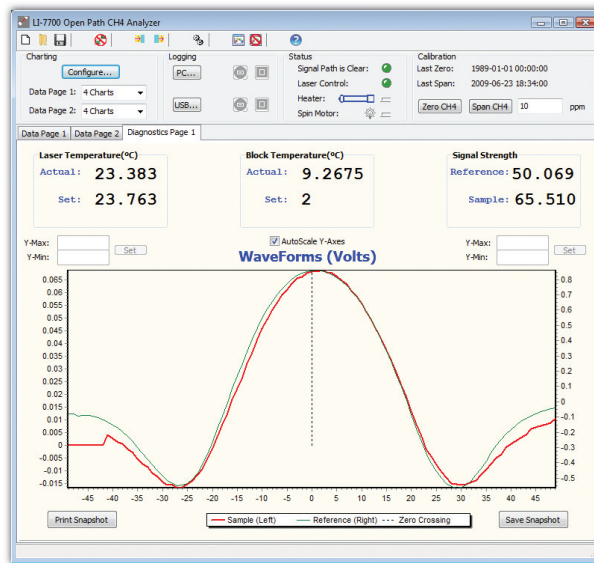

The above display indicates normal operation by the following features:

- A standard bell shaped curve is seen for both the sample and reference paths
- Both are overlaid nicely, with the peak at or very near the zero point on the horizontal axis
- The waveform has sufficient depth (e.g., not too shallow vertically)

The two status indicators located in the status panel above the chart display should further support this state. Both the Laser Temperature and Reference Lock indicators should show green. If either or both are red, then the instrument is not functioning normally and it may be necessary to manually adjust the laser temperature parameters. When the laser is scanning

across the desired methane absorption feature, line lock is established. Otherwise, line lock is not established and the instrument will not measure methane density.

### ***Opening the Laser Temperature Control Dialog***

1. Place the mouse pointer over the red light indicator on the status panel and click the left mouse button (the indicator must be red to complete this action).

-or-

2. Press the Ctrl, Alt and L keys simultaneously. This can be done at any time when you are connected to an instrument.

The Laser Temperature Control dialog will open:

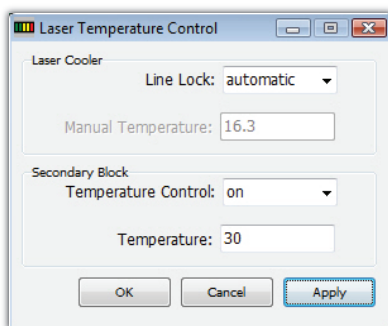

It is only possible to open this dialog when the application is connected to an instrument. As the dialog indicates, there are two temperature parameters that may be manipulated. Laser Cooler temperature is the primary one and should be altered first. In order to change the value, the Line Lock setting must be changed from “Automatic” to “Manual”, as shown below.

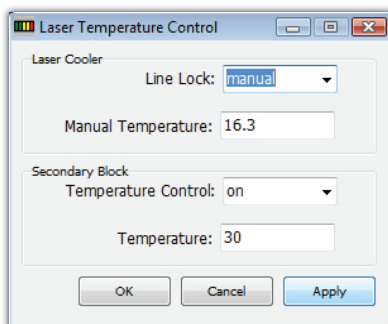

This will allow you to set the temperature manually. When you are changing the laser cooler temperature, watch the diagnostics page and see how the waveform changes as the temperature setting is increased or decreased.

### Manual Line Lock Example

In this example, the automatic line lock was disabled and the laser temperature was manually driven from a value of 10.0 to 16.0. This resulted in the following waveform display:

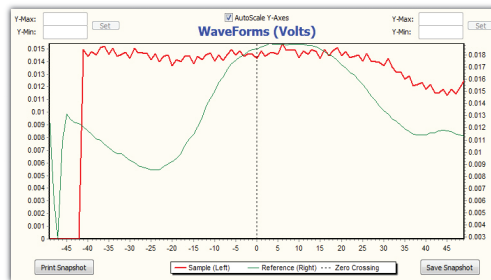

At this point, the desired positions could be either to the right or to the left. Since the line lock temperature value was known to be higher, the values were incremented in single digits (e.g., 11, 12, ..., 16), and the following series of images were taken:

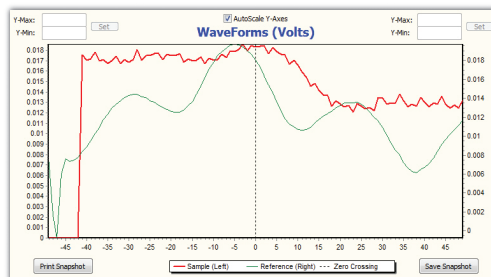
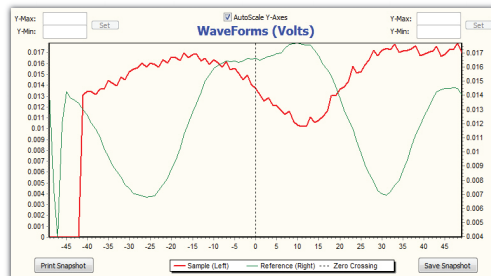

# 7 Advanced Operation

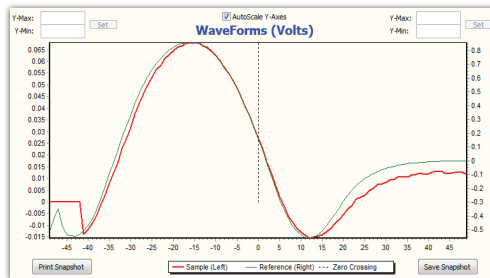
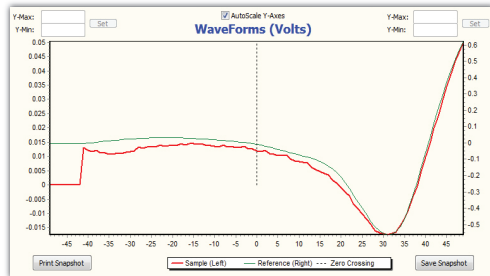
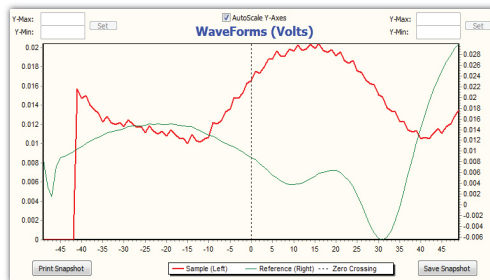
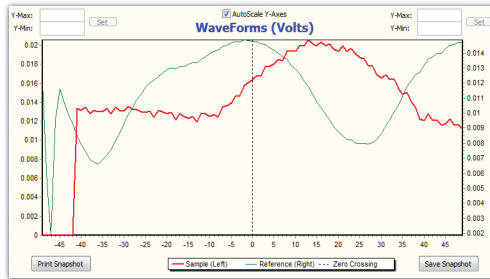

### ***Re-enabling Automatic Line Lock***

As the previous images show, the waveform is gradually shifting from right to left as the temperature parameter is increased from 10.0 to 16.0 °C. At this point, since the top of the bell shape is relatively close to the zero point on the horizontal axis, you can attempt to have the instrument re-lock automatically by setting the line lock parameter back to “automatic.” This should cause the wave to slide further to the right or left until the peak is at or very near the zero point. If this does in fact occur, the relocking was successful and the dialog may be closed. If not, repeat the process, or simply restart the instrument.

## **Networking**

The LI-7700 supports IPv4 and IPv6. IPv4 is the first Internet Protocol to be widely used. It is nearly 20 years old and will be superseded by IPv6. IPv6 provides many advantages, one of which is that it allows for substantially more IP address. This will help accommodate the growing number of devices that are connected to the Internet.

### **Enabling IPv6 on Windows XP**

Microsoft® Windows XP includes IPv6 but it is not enabled by default. Windows Vista and 7 have IPv6 enabled by default. The following steps will install IPv6 on Windows XP (administrative privileges may be required):

1. Click the **Start** menu, and then click **All Programs**. Click **Accessories**, and then click **Command Prompt**.
2. At the command prompt, type: **ipv6 install** and press the **Enter** key.

## The LI-7700 Finder Application

To use the LI-7700 finder Application, connect to the LI-7700 (and LI-7550 if applicable) using the Ethernet connection. The finder application will not “see” devices that are connected using the RS-232 serial connection.



**Caution:** The LI-7700 Finder Application provides access to advanced settings. Changing some of these settings may undesirably alter the performance of your LI-7700. Use caution when altering these settings, and consult with LI-COR Biosciences technical support personnel if you have questions.

The LI-7700 Finder provides access to internal LI-7700 settings, many of duplicated in the normal software interface. It also is used to set the LI-7550 clock. To launch the application click the help question mark  > **About** > **Factory Setup...** > **Proceed**. Upon launching the application, you will see a list of all LI-7700s and LI-7550s on your local network.

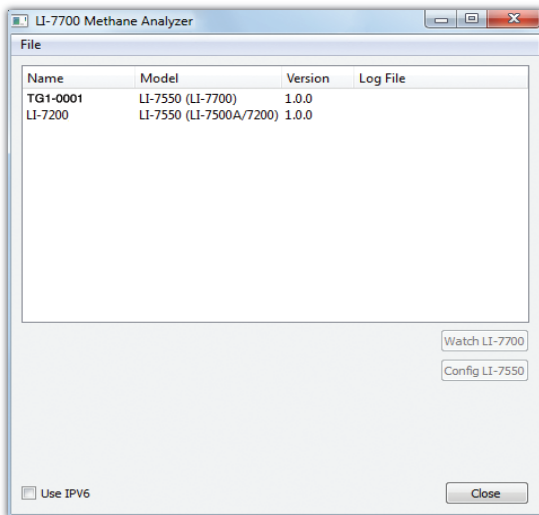

When you select an LI-7700, you can select **Watch LI-7700**, or when you select an LI-7550 you can choose **Config LI-7550**.

Selecting **Watch LI-7700** opens a variables window:

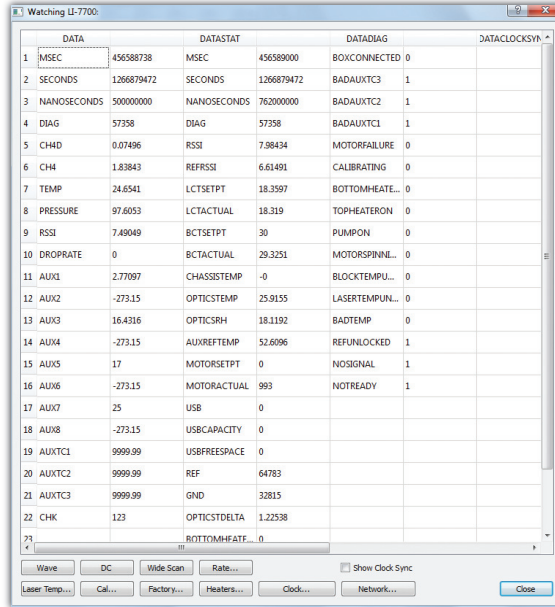

DATA		DATASAT		DATADIAG		DATACLOCKSYN
1	MSEC	456588738	MSEC	456589000	BOXCONNECTED	0
2	SECONDS	1.266879472	SECONDS	1.266879472	BADAUXTC3	1
3	NANOSECONDS	500000000	NANOSECONDS	762000000	BADAUXTC2	1
4	DIAG	57358	DIAG	57358	BADAUXTC1	1
5	CH4D	0.07496	RSSI	7.98434	MOTORFAILURE	0
6	CH4	1.83843	REFRSSI	6.61491	CALIBRATING	0
7	TEMP	24.6541	LCTSETPT	18.3597	BOTTOMHEATE...	0
8	PRESSURE	97.6053	LCTACTUAL	18.319	TOPHEATERON	0
9	RSSI	7.49049	BCTSETPT	30	PUMPON	0
10	DROPRATE	0	BCTACTUAL	29.3251	MOTORSPINNL...	0
11	AUX1	2.77097	CHASSISTEMP	-0	BLOCKTEMPU...	0
12	AUX2	-273.15	OPTICSTEMP	25.9155	LASERTEMPUN...	0
13	AUX3	16.4316	OPTICSRH	18.1192	BADTEMP	0
14	AUX4	-273.15	AUXREFTEMP	52.6096	REFUNLOCKED	1
15	AUX5	17	MOTORSETPT	0	NOSIGNAL	1
16	AUX6	-273.15	MOTORACTUAL	993	NOTREADY	1
17	AUX7	25	USB	0		
18	AUX8	-273.15	USBCAPACITY	0		
19	AUXTC1	9999.99	USBFREESPACE	0		
20	AUXTC2	9999.99	REF	64783		
21	AUXTC3	9999.99	GND	32815		
22	CHK	123	OPTICSDelta	1.22538		
23			BOTTOMHFATE...	0		

Buttons at the bottom: Wave, DC, Wide Scan, Rate..., Show Clock Sync, Laser Temp..., Cal..., Factory..., Heaters..., Clock..., Network..., Close

This displays numerous parameters used by the LI-7700. Along the bottom of the window are nine buttons, which are described below:

Click the **Wave** button:

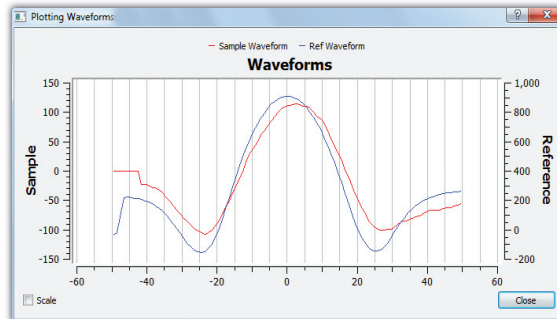

The window above shows the waveform. It is identical to the waveform displayed in the Diagnostic Page 1 tab on the Main View.



Click the **DC** button:

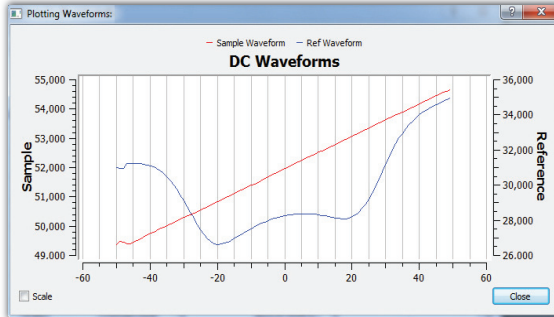

This window shows the un-inverted measurement of the sample and reference.

Click the **Wide Scan** button:

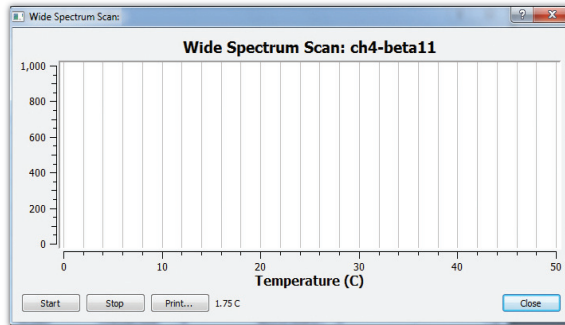

This window can be used to gather diagnostic information. After performing a wide scan you either must select “Rollback” in the **Factory Settings** dialog or restart the instrument to restore normal operation.

Click the **Laser Temp...** button:

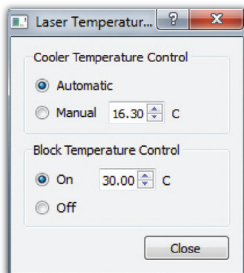

The laser temperature control dialog is similar to the Laser Temperature control described above in the Manual Line Lock example (page 7-5).

Click the **Cal...** button:

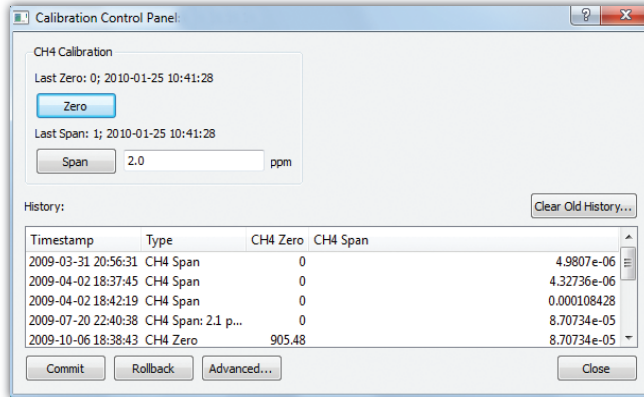

This advanced calibration tab provides access to many of the same calibration functions available in the Main View.

Click the **Factory...** button:

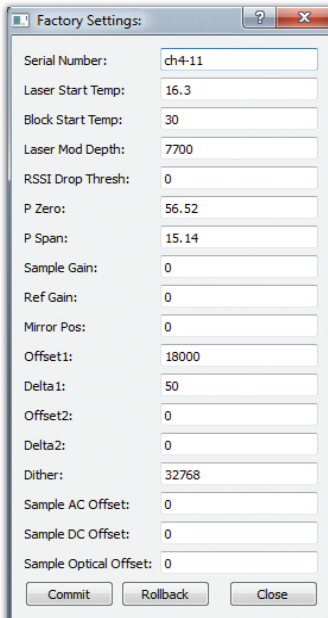

The window above is used to perform diagnostic checks. Do not change any settings in this window unless in consultation with LI-COR Biosciences technical support.

Click the **Heaters...** button:

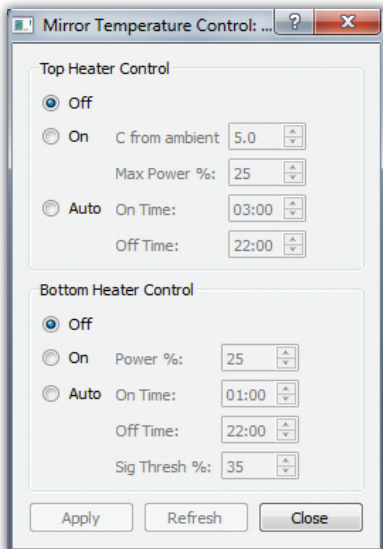

Provides access to mirror heater controls.

Click the **Clock...** button:

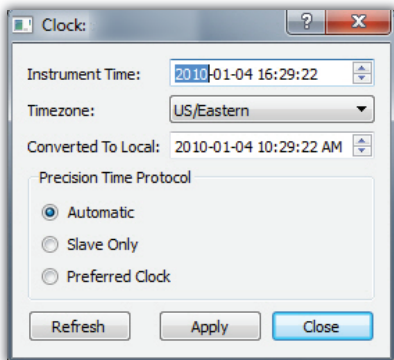

Here you can set the LI-7700 clock.

Click the **Network...** button:

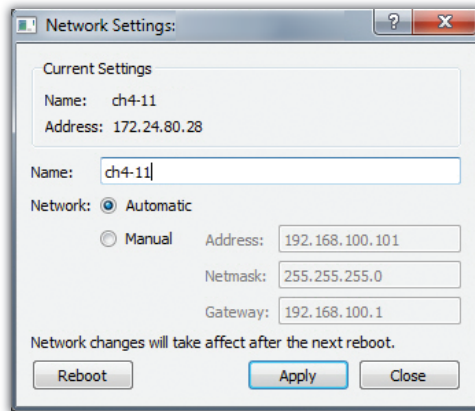

This window allows you to change the instrument name and network settings.

## Communications Grammar

### Introduction

This section describes the protocol used by the LI-7700 to communicate via RS-232 and Ethernet for both configuration and data output purposes. Commands sent to the LI-7700 have a certain structure that must be followed, and data sent by the LI-7700 comes packaged in a particular way.

When you communicate with the LI-7700 with a Transmission Control Protocol (TCP) connection, the LI-7700 address should be in the form:

```
XXX.XXX.XXX.XXX:YYYY
```

where XXX represents an integer number from 0-255 and YYYY represents the port number. All LI-7700s use the port number 7700 by default.

### LI-7700 Communications

The configuration grammar used to communicate with the LI-7700 is based upon the eXtensible Markup Language (XML). XML relies on the use of tags to “markup”, or give structural rules to a set of data.

A tag is a descriptive identifier, enclosed between a less than (<) and greater than (>) symbol, used in part to describe a piece of data. For example, <NAME> is a tag that describes someone’s name. Each tag must have a corresponding end tag, denoted by ‘/’. Extending the example above, the end tag of <NAME> is </NAME>.

Elements are the basic unit of XML content. An element consists of a start tag and an end tag, and everything in between. For example, consider the following element:

```
<NAME>Jane</NAME>.
```

In this example, <NAME> (start tag) and </NAME> (end tag) comprise the markup, and “Jane” comprises the data.

Elements can also contain other elements other than data.

```
<NAME>  
    <FIRST>Jane</FIRST>  
    <LAST>Smith</LAST>  
</NAME>
```

In this example, the outermost element <NAME> encompasses two other elements that contain data. All elements combined make up the XML document.

## Element Descriptions

The following types of data are used in XML grammar:

{val   val   val   ...}	The value will be a member of the specified set. The “ ” means “or”.
{bool}	Boolean values, TRUE   FALSE.
{float}	Floating point values in decimal or exponential notation.
{int}	Integer
{string}	String

## Grammar

A full LI-7700 XML file will resemble the following:

```
<licor>
  <li7700>
    <ver>{string}</ver>
    <name>{string}</name>
    <serialnumber>{string}</serialnumber>
    <ipaddress>{string}</ipaddress>
    <output>
      <rate>{0|1|2|5|10|20|40}</rate>
      <waveforms>{true|false}</waveforms>
      <status>{true|false}</status>
      <dataclock>{true|false}</dataclock>
    </output>
    <box>
      <output>
        <data>
          <msec>{true|false}</msec>
          <seconds>{true|false}</seconds>
          <nanoseconds>{true|false}</nanoseconds>
          <diag>{true|false}</diag>
          <ch4>{true|false}</ch4>
          <ch4d>{true|false}</ch4d>
          <temp>{true|false}</temp>
          <pressure>{true|false}</pressure>
          <rssi>{true|false}</rssi>
          <droprate>{true|false}</droprate>
          <aux1>{true|false}</aux1>
          <aux2>{true|false}</aux2>
          <aux3>{true|false}</aux3>
          <aux4>{true|false}</aux4>
          <aux5>{true|false}</aux5>
        </data>
      </output>
    </box>
  </li7700>
</licor>
```

```

    <aux6>{true|false}</aux6>
    <aux7>{true|false}</aux7>
    <aux8>{true|false}</aux8>
    <auxtcl>{true|false}</auxtcl>
    <auxtc2>{true|false}</auxtc2>
    <auxtc3>{true|false}</auxtc3>
    <chk>{true|false}</chk>
</data>
<waveforms>{true|false}</waveforms>
<status>{true|false}</status>
<dataclock>{true|false}</dataclock>
</output>
<usb>
  <data>
    <msec>{true|false}</msec>
    <seconds>{true|false}</seconds>
    <nanoseconds>{true|false}</nanoseconds>
    <diag>{true|false}</diag>
    <ch4>{true|false}</ch4>
    <ch4d>{true|false}</ch4d>
    <temp>{true|false}</temp>
    <pressure>{true|false}</pressure>
    <rssi>{true|false}</rssi>
    <droprate>{true|false}</droprate>
    <aux1>{true|false}</aux1>
    <aux2>{true|false}</aux2>
    <aux3>{true|false}</aux3>
    <aux4>{true|false}</aux4>
    <aux5>{true|false}</aux5>
    <aux6>{true|false}</aux6>
    <aux7>{true|false}</aux7>
    <aux8>{true|false}</aux8>
    <auxtcl>{true|false}</auxtcl>
    <auxtc2>{true|false}</auxtc2>
    <auxtc3>{true|false}</auxtc3>
    <chk>{true|false}</chk>
    <date>{true|false}</date>
    <time>{true|false}</time>
  </data>
  <status>{same_file|separate_file|off}</status>
  <split>{0|15|30|60|90|120|180|240|1440}</split>
</usb>
</box>
<cfg>
  <temprange>{low|high}</temprange>
  <clock>
    <time>{string:00:00:00}</time>
    <date>{string:1970-01-01}</date>
    <zone>{enter your time zone}</zone>
    <ptp>{auto|slaveonly|preferred}</ptp>
  </clock>
  <network>
    <name>{string:ch4-xxxx}</name>
    <configuration>{auto|manual}</configuration>
    <ipaddress>{int.int.int.int}</ipaddress>
    <netmask>{int.int.int.int}</netmask>

```

```
<gateway>{int.int.int.int}</gateway>
</network>
<aux1>
  <type>{poly|steinhart|linear-rt}</type>
  <a0>{float:0}</a0>
  <a1>{float:1}</a1>
  <a2>{float:0}</a2>
  <a3>{float:0}</a3>
</aux1>
<aux2>
  <type>{poly|steinhart|linear-rt}</type>
  <a0>{float:0}</a0>
  <a1>{float:1}</a1>
  <a2>{float:0}</a2>
  <a3>{float:0}</a3>
</aux2>
<aux3>
  <type>{poly|steinhart|linear-rt}</type>
  <a0>{float:0}</a0>
  <a1>{float:1}</a1>
  <a2>{float:0}</a2>
  <a3>{float:0}</a3>
</aux3>
<aux4>
  <type>{poly|steinhart|linear-rt}</type>
  <a0>{float:0}</a0>
  <a1>{float:1}</a1>
  <a2>{float:0}</a2>
  <a3>{float:0}</a3>
</aux4>
<aux5>
  <type>{poly|steinhart|linear-rt}</type>
  <a0>{float:0}</a0>
  <a1>{float:1}</a1>
  <a2>{float:0}</a2>
  <a3>{float:0}</a3>
</aux5>
<aux6>
  <type>{poly|steinhart|linear-rt}</type>
  <a0>{float:0}</a0>
  <a1>{float:1}</a1>
  <a2>{float:0}</a2>
  <a3>{float:0}</a3>
</aux6>
<aux7>
  <type>{poly|steinhart|linear-rt}</type>
  <a0>{float:0}</a0>
  <a1>{float:1}</a1>
  <a2>{float:0}</a2>
  <a3>{float:0}</a3>
</aux7>
<aux8>
  <type>{poly|steinhart|linear-rt}</type>
  <a0>{float:0}</a0>
  <a1>{float:1}</a1>
  <a2>{float:0}</a2>
```



```

    <a3>{float:0}</a3>
  </aux8>
  <dac1>
    <set>{float:0;-5...5}</set>
<src>{set|ch4d|ch4|temp|pressure|rssi|droprate|aux1|aux2|aux3|aux4|aux5|aux6|aux7|aux8
|auxtc1|auxtc2|auxtc3}</src>
  <low>{float:0}</low>
  <high>{float:0}</high>
</dac1>
<dac2>
  <set>{float:0;-5...5}</set>

<src>{set|ch4d|ch4|temp|pressure|rssi|droprate|aux1|aux2|aux3|aux4|aux5|aux6|aux7|aux8
|auxtc1|auxtc2|auxtc3}</src>
  <low>{float:0}</low>
  <high>{float:0}</high>
</dac2>
<dac3>
  <set>{float:0;-5...5}</set>

<src>{set|ch4d|ch4|temp|pressure|rssi|droprate|aux1|aux2|aux3|aux4|aux5|aux6|aux7|aux8
|auxtc1|auxtc2|auxtc3}</src>
  <low>{float:0}</low>
  <high>{float:0}</high>
</dac3>
<dac4>
  <set>{float:0;-5...5}</set>

<src>{set|ch4d|ch4|temp|pressure|rssi|droprate|aux1|aux2|aux3|aux4|aux5|aux6|aux7|aux8
|auxtc1|auxtc2|auxtc3}</src>
  <low>{float:0}</low>
  <high>{float:0}</high>
</dac4>
<dac5>
  <set>{float:0;-5...5}</set>

<src>{set|ch4d|ch4|temp|pressure|rssi|droprate|aux1|aux2|aux3|aux4|aux5|aux6|aux7|aux8
|auxtc1|auxtc2|auxtc3}</src>
  <low>{float:0}</low>
  <high>{float:0}</high>
</dac5>
<dac6>
  <set>{float:0;-5...5}</set>

<src>{set|ch4d|ch4|temp|pressure|rssi|droprate|aux1|aux2|aux3|aux4|aux5|aux6|aux7|aux8
|auxtc1|auxtc2|auxtc3}</src>
  <low>{float:0}</low>
  <high>{float:0}</high>
</dac6>
<heater>
  <top>
    <heaterpower>{integer:100;0...100}</heaterpower>
    <control>{auto|on|off}</control>
    <ontime>{HH:MM}</ontime>
    <offtime>{HH:MM}</offtime>
    <deltat>{float:0;-5...5}</deltat>

```

```

</top>
<bottom>
  <heaterpower>{integer:100;0...100}</heaterpower>
  <control>{auto|on|off}</control>
  <ontime>{HH:MM}</ontime>
  <offtime>{HH:MM}</offtime>
  <signalstrengthlevel>{integer:40;0...100}</signalstrengthlevel>
</bottom>
</heater>
<linelock>
  <lasercooler>
    <control>{auto|manual|daccount}</control>
    <temp>{float:25;0...50}</temp>
    <daccount>{integer:0;0...65535}</daccount>
  </lasercooler>
  <laserblock>
    <control>{off|on|daccount}</control>
    <temp>{float:22;0...50}</temp>
    <daccount>{integer:0;0...65535}</daccount>
  </laserblock>
</linelock>
<spinmirror>
  <control>{auto|on|off}</control>
  <ontime>{HH:MM}</ontime>
  <offtime>{HH:MM}</offtime>
  <duration>{integer:30;0...300}</duration>
  <repeatinterval>{HH:MM}</repeatinterval>
  <signalstrengthlevel>{integer:40;0...100}</signalstrengthlevel>
</spinmirror>
<sdmaddress>{integer:0;0...15}</sdmaddress>
</cfg>
<cal>
  <ch4zero>{float:0}</ch4zero>
  <ch4span>{float:1}</ch4span>
  <ch4spanconc>{float:2}</ch4spanconc>
  <ch4lastzero>{YYYY-MM-DD HH:MM:SS.SS}</ch4lastzero>
  <ch4lastspan>{YYYY-MM-DD HH:MM:SS.SS}</ch4lastspan>
<history>
  <record>
    <time>{YYYY-MM-DD HH:MM:SS.SS}</time>
    <type>{string}</type>
    <ch4zero>{float:0}</ch4zero>
    <ch4span>{float:1}</ch4span>
  </record>
  <record>
    <time>{YYYY-MM-DD HH:MM:SS.SS}</time>
    <type>{string}</type>
    <ch4zero>{float:0}</ch4zero>
    <ch4span>{float:1}</ch4span>
  </record>
  <record>
    <time>{YYYY-MM-DD HH:MM:SS.SS}</time>
    <type>{string}</type>
    <ch4zero>{float:0}</ch4zero>
    <ch4span>{float:1}</ch4span>
  </record>
  <record>
    <time>{YYYY-MM-DD HH:MM:SS.SS}</time>
    <type>{string}</type>
    <ch4zero>{float:0}</ch4zero>
    <ch4span>{float:1}</ch4span>
  </record>
</history>
</cal>

```

```

<record>
  <time>{YYYY-MM-DD HH:MM:SS.SS}</time>
  <type>{string}</type>
  <ch4zero>{float:0}</ch4zero>
  <ch4span>{float:1}</ch4span>
</record>
<record>
  <time>{YYYY-MM-DD HH:MM:SS.SS}</time>
  <type>{string}</type>
  <ch4zero>{float:0}</ch4zero>
  <ch4span>{float:1}</ch4span>
</record>
<record>
  <time>{YYYY-MM-DD HH:MM:SS.SS}</time>
  <type>{string}</type>
  <ch4zero>{float:0}</ch4zero>
  <ch4span>{float:1}</ch4span>
</record>
<record>
  <time>{YYYY-MM-DD HH:MM:SS.SS}</time>
  <type>{string}</type>
  <ch4zero>{float:0}</ch4zero>
  <ch4span>{float:1}</ch4span>
</record>
</history>
</cal>
<cmd>
  <poll>{true|false}</poll>
  <ch4zero>{true|false}</ch4zero>
  <ch4span>{true|false}</ch4span>
  <calcommit>{true|false}</calcommit>
  <calrollback>{true|false}</calrollback>
  <calabort>{true|false}</calabort>
  <logusbstart>{true|false}</logusbstart>
  <logusbstop>{true|false}</logusbstop>
  <reboot>{true|false}</reboot>
  <polltest>{true|false}</polltest>
  <linelock>{true|false}</linelock>
</cmd>
<cpld>
  <ver>{string}</ver>
  <motor>
    <control>{integer:0}</control>
    <desired_pos>{integer:0}</desired_pos>
    <actual_pos>{integer:0}</actual_pos>
  </motor>
</cpld>
<factory>
  <serialnumber>{string:ch4-XXXX}</serialnumber>
  <lasermoddepth>{integer:7000}</lasermoddepth>
  <laserstarttemp>{float:22;0...50}</laserstarttemp>
  <blockstarttemp>{float:30;0...50}</blockstarttemp>
  <blockstarttemplovrage>{float:5;0...50}</blockstarttemplovrage>
  <rssidrophresh>{float:1;0...100}</rssidrophresh>
  <pzero>{float:0}</pzero>
  <pspan>{float:1}</pspan>

```

```

<samplegain>{integer:0;0...2147483647}</samplegain>
<refgain>{integer:0;0...2147483647}</refgain>
<mirrorpos>{integer:0;0...1023}</mirrorpos>
<offset1>{integer:0;0...65535}</offset1>
<delta1>{integer:0;0...65535}</delta1>
<offset2>{integer:0;0...65535}</offset2>
<delta2>{integer:0;0...65535}</delta2>
<dither>{integer:0;0...65535}</dither>
<sampledcoffset>{integer:0;0...65535}</sampledcoffset>
<sampleacoffset>{integer:0;-32768...32767}</sampleacoffset>
<sampleopticaloffset>{integer:0;-32768...32767}</sampleopticaloffset>
<cmd>
  <commit>{true|false}</commit>
  <rollback>{true|false}</rollback>
</cmd>
</factory>
</li7700>
</licor>

```

## Configuration File Grammar

Configuration files are constructed when you save an instrument configuration (see page 2-19). You can view or edit the configuration grammar by opening the configuration file in an HTML editor or text editor. Below is an example of a typical configuration file with hypothetical values for elements:

```

<licor>
  <li7700>
    <box></box>
    <cfg>
      <sdmaddress>0</sdmaddress>
      <aux1>
        <type>poly</type>
        <a0>0</a0>
        <a1>1</a1>
        <a2>0</a2>
        <a3>0</a3>
      </aux1>
      <aux2>
        <type>poly</type>
        <a0>0</a0>
        <a1>1</a1>
        <a2>0</a2>
        <a3>0</a3>
      </aux2>
      <aux3>
        <type>poly</type>
        <a0>0</a0>
        <a1>1</a1>
        <a2>0</a2>
        <a3>0</a3>
      </aux3>
      <aux4>
        <type>poly</type>

```

```

        <a0>0</a0>
        <a1>1</a1>
        <a2>0</a2>
        <a3>0</a3>
    </aux4>
    <aux5>
        <type>poly</type>
        <a0>0</a0>
        <a1>1</a1>
        <a2>0</a2>
        <a3>0</a3>
    </aux5>
    <aux6>
        <type>poly</type>
        <a0>0</a0>
        <a1>1</a1>
        <a2>0</a2>
        <a3>0</a3>
    </aux6>
    <aux7>
        <type>poly</type>
        <a0>0</a0>
        <a1>1</a1>
        <a2>0</a2>
        <a3>0</a3>
    </aux7>
    <aux8>
        <type>poly</type>
        <a0>0</a0>
        <a1>1</a1>
        <a2>0</a2>
        <a3>0</a3>
    </aux8>
    <heater>
        <top>
            <heaterpower>25</heaterpower>
            <control>off</control>
            <deltat>5</deltat>
            <ontime>03:00</ontime>
            <offtime>22:00</offtime>
        </top>
        <bottom>
            <heaterpower>25</heaterpower>
            <control>off</control>
            <signalstrengthlevel>35</signalstrengthlevel>
            <ontime>01:00</ontime>
            <offtime>22:00</offtime>
        </bottom>
    </heater>
    <linelock>
        <lasercooler>
            <control>auto</control>
            <temp>16.3</temp>
        </lasercooler>
    </laserblock>

```

```
                <control>on</control>
                <temp>30</temp>
            </laserblock>
        </linelock>
    <spinmirror>
        <control>off</control>
        <ontime>00:00</ontime>
        <offtime>00:00</offtime>
        <duration>70</duration>
        <repeatinterval>00:03</repeatinterval>
        <signalstrengthlevel>100</signalstrengthlevel>
    </spinmirror>
    <dac1>
        <set>0</set>
        <src>ch4</src>
        <low>0</low>
        <high>5</high>
    </dac1>
    <dac2>
        <set>0</set>
        <src>temp</src>
        <low>0</low>
        <high>0</high>
    </dac2>
    <dac3>
        <set>0</set>
        <src>pressure</src>
        <low>0</low>
        <high>0</high>
    </dac3>
    <dac4>
        <set>0</set>
        <src>rssi</src>
        <low>0</low>
        <high>0</high>
    </dac4>
    <dac5>
        <set>0</set>
        <src>rssi</src>
        <low>0</low>
        <high>0</high>
    </dac5>
    <dac6>
        <set>0</set>
        <src>rssi</src>
        <low>0</low>
        <high>0</high>
    </dac6>
</cfg>
</li7700>
</licor>
```

## Sending Commands

Example commands are presented below.

### ***To request a data record:***

```
<licor><li7700><cmd><poll>true</poll></cmd></li7700></licor>
```

This will retrieve a complete data record.

### ***To change the mirror heater settings:***

```
<licor><li7700><cfg>
  <heater>
    <top>
      <control> on | off | auto </control>
      <deltat> {float (-5.0 - 5.0)} </deltat>
      <heaterpower>{Int}</heaterpower>
      <ontime>{HH:MM}</ontime>
      <offtime>{HH:MM}</offtime>
    </top>
    <bottom>
      <heaterpower>{Int}</heaterpower>
      <control>{auto | on | off}</control>
      <signalstrenglevel>{Int}</signalstrengthlevel>
      <ontime>{HH:MM}</ontime>
      <offtime>{HH:MM}</offtime>
    </bottom>
  </heater>
</cfg></li7700></licor>
```

This would change the mirror heater settings to whichever values you specify.

### ***To set the temperature range to the 0C...50C range:***

```
<licor><li7700><cfg><temprange>high</temprange></cfg></li7700></licor>
```

### ***To set the temperature range to the -25C...25C range:***

```
<licor><li7700><cfg><temprange>low</temprange></cfg></li7700></licor>
```

### ***To force the instrument to re-linlock:***

```
<licor><li7700><cmd><linelock>true</linelock></cmd></li7700></licor>
```

# 8 Appendices

---

## Appendix A. Specifications

### LI-7700 Open Path CH<sub>4</sub> Analyzer

<b>Calibration Range:</b>	0-40 ppm @ 25 °C 0-25 ppm @ -25 °C 0-50 ppm total
<b>Bandwidth:</b>	0, 1, 2, 5, 10, or 20 Hz
<b>Linearity:</b>	Within 1% of reading across full calibration range
<b>Resolution:</b>	5 ppb (RMS @ 10 Hz, typical ambient levels)
<b>Operating Temperature Range:</b>	-25 °C to 50 °C
<b>Operating Pressure Range:</b>	50 to 110 kPa
<b>Relative Humidity Range:</b>	0 to 100%
<b>Detection Method:</b>	Wavelength Modulation Spectroscopy, 2f Detection
<b>Data Communication:</b>	Ethernet
<b>Data Inputs:</b>	4 Analog Inputs (single ended, ±5 V, 16 bit), 3 type E thermocouple
<b>Power Requirements:</b>	10.5 to 30 VDC
<b>Power Consumption:</b>	8 watts nominally, up to 41 watts with accessories, see page 8-3 for details.
<b>Size:</b>	14.33 cm dia. (5.64 in), 82.8 cm height (32.6 in)
<b>Weight:</b>	5.2 kg (11.5 lbs.)
<b>Optical Path:</b>	0.5 m physical path length (1.65 ft), 30 m measurement path (98.4 ft)
<b>Cable Length (Power and Data):</b>	5 m (16.4 ft)



### 7700-101 Washer Assembly

<b>Power Requirements:</b>	8 watts, see page 8-3 for details.
<b>Size:</b>	44.5 × 32.8 × 15 cm (17.5 × 12.9 × 6 in) external dimensions
<b>Weight:</b>	3.2 kg (7 lbs)
<b>Fluid Capacity:</b>	4 L (1.1 U.S. gallons)
<b>Maximum pumping height:</b>	5 m above pump with provided tubing and nozzle
<b>Cable Length:</b>	5 m (16.4 ft)
<b>Tube Length:</b>	5 m (16.4 ft)

### LI-7550 Analyzer Interface Unit (optional)

<b>Data Storage:</b>	Removable USB Storage. 4 GB provided, (>1 TB max; expandable with user-supplied industrial grade USB Flash Drive)
<b>Data Communication:</b>	Ethernet Synchronous Devices for Measurement (33.3 Hz) RS-232 (57,600 baud, 20 records per second) 6 Digital-to-Analog Converters (0-5 V, 300 Hz)
<b>Inputs:</b>	Ethernet, 4 Analog Inputs (differential, ±5 V, 16 bit)
<b>Operating Temperature Range:</b>	-25 °C to 50 °C
<b>Power Requirements:</b>	10.5 to 30 VDC
<b>Power Consumption:</b>	10W nominally
<b>Dimensions:</b>	35 × 30 × 15 cm (13.8 × 12 × 6 in) external dimensions
<b>Weight:</b>	4.4 kg (10 lbs)
<b>Cable Length (Power, Data, Analog Input/Output, Ethernet, and SDM):</b>	5 m (16.4 ft)

### 7550-101 Auxiliary Sensor Interface (optional)

<b>Size:</b>	11.5 × 6.5 × 4.2 cm (4.5 × 2.6 × 1.7 in.)
<b>Weight:</b>	0.39 kg (0.85 lbs) including mounting bracket
<b>Cable Length:</b>	0.75 m (2.5 ft)

## Power Requirements Summary

The LI-7700 uses about 8 watts during normal operation, but when accessories and mirror heaters are used, power requirements could be up to or greater than 41 watts. Table 8-1 can be used to determine how much power is required in a variety of configurations:

*Table 8-1. Typical LI-7700 power requirements for a variety of configurations.*

	CH <sub>4</sub> Analyzer	Washer Assembly	Mirror Heaters		LI-7550	Power Consumption
			Upper	Lower		
Normal Operation (watts)	8					<b>8</b>
	8				10	<b>18</b>
During Cleaning Cycle (watts)*	8	8				<b>16</b>
	8	8			10	<b>26</b>
Mirror Heaters On (watts)†	8		0 to 7.5			<b>8 to 15.5</b>
	8		0 to 7.5	0 to 7.5		<b>8 to 23</b>
	8		0 to 7.5	0 to 7.5	10	<b>18 to 33</b>
	8	8	0 to 7.5	0 to 7.5	10	<b>26 to 41</b>

\*Cleaning cycle duration is from 10 to 120 seconds. Cleaning cycle frequency and duration are user settable.

†Power used for mirror heaters is from 0 to 7.5 watts each, linear with power setting.

## Appendix B. Maintenance

### Changing the Internal Desiccant Bottle

There is one internal desiccant bottle in the LI-7700. The desiccant cap is above the circular plug located on the bottom of the top dome of the analyzer between two spars (see below). The desiccant bottle should be changed annually when the LI-7700 is used in humid environments. Desiccant bottles and recharge kits are available from LI-COR (see page 8-11).

In the Calibration frame in the (page 2-3), there is a field that reads “Optics RH:”. Normally this should be near zero. If the indicator turns from green to red (indicating the optics RH: >30%), then it is time to change the desiccant. To change the desiccant:

1. Remove the setscrew that secures the desiccant plug. If it is not in place, insert the knurled screw from the spares kit (p/n 125-09760) into the desiccant plug. Grip the screw with your fingers or a pair of pliers and pull straight out to remove the desiccant plug.



2. **Remove the seal from the top of the replacement desiccant bottle.** Insert the bottle cap first and replace the cover. Press firmly to secure the desiccant cover and replace the setscrew.



Over time, the “Optics RH:” should approach zero. This may take several minutes to several hours, depending on the humidity level. There should be no need to perform any other maintenance procedures (e.g., zero or span) after this.



**Note:** a droplet of saliva or dish soap applied to the o-rings can ease insertion of the desiccant cover.

## Changing the Thermocouple

The fine wire thermocouple should be replaced if the wire is broken or if it reads incorrectly. One spare thermocouple is included in the spares kit, and others can be purchased from LI-COR Biosciences (p/n 9977-038). To replace the thermocouple:

1. Disconnect the power supply to turn the LI-7700 off.
2. Fully loosen the two screws (#1 Philips) that secure the thermocouple assembly to the bottom of the upper housing. The screws will be retained in the thermocouple base.



3. Grasp the thermocouple housing and pull it straight out. It should slide out fairly easily.



4. Insert the new thermocouple. Do not force it in, and be sure the bend is directed toward the optical path. Handle the thermocouple carefully to protect the fine wires.
5. Replace the two screws and remove the protective cover. Connect with the LI-7700 and verify that the temperature readings are correct.

## Changing the LI-7700 Fuse

If the LI-7700 fails to power up when connected to a suitable power supply, check to see if the fuse has blown. The LI-7700 fuse is enclosed within the knurled fuse cover on the connection panel. One extra 250V type F 5.0 Amp fuse (p/n 438-09800) is included in the spares kit. To replace the fuse, disconnect the power supply to power off the LI-7700, remove the fuse cover (located on the connection panel, see below) and pull out the old fuse. Insert the replacement fuse and reattach the fuse cover.



## Changing the LI-7550 Fuse

The LI-7550 power supply is protected by a 5A 125/250V, 5x 20 mm fast blow fuse located near the connection panel inside the Analyzer Interface Unit case. If the LI-7550 fails to power up when connected to a suitable power supply, check to see if the fuse has blown.

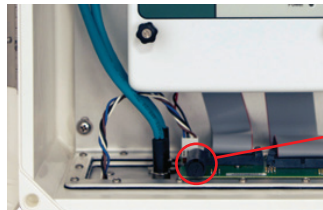

Fuse holder cover -  
turn counterclockwise  
to release

To check the fuse, disconnect the power cable to turn off the unit and open the case of the LI-7550 Analyzer Interface Unit. The fuse is located on the inside wall, opposite the connection panel, in the lower left hand corner, as shown above. Replacement fuses (p/n 439-04214 in the spares kit) plug into the fuse holder. Use a standard screwdriver to push down on the fuse holder cap and turn counterclockwise to release the cap. Check the fuse and replace if necessary. Note that sometimes it may not be evident that the fuse has blown and an ohmmeter may be used to check the status of the fuse.

## Appendix C. Troubleshooting

### **LI-7700 will not power up:**

Power supply inadequate – be sure the power supply is 10.5 to 30 VDC, 3 Amps.

Power supply connected improperly – this will blow the fuse. Connect the power supply correctly and replace the fuse.

Blown fuse – replace the fuse.

### **Lower mirror spin motor runs loudly at startup:**

Power supply inadequate – be sure the power supply is 10.5 to 30 VDC, 3 Amps.

### **Temperature readings are unreasonable:**

Thermocouple damaged – replace the optical path thermocouple.

### **LI-7700 not visible on the network:**

Check the Ethernet data cable connections.

### **Pressure measurements noisy:**

The mirror washer causes perturbations in the pressure measurement due to the proximity of the pressure sensor to the lower mirror. One way to reduce this effect is to set the cleaner to operate less frequently.

### **Optics RH warning in the software or diagnostic data:**

Desiccant needs to be replaced. The RH warning turns on if the relative humidity in the head is over 30%.

### **Data loss during night/morning hours:**

Mirrors may be covered in condensation. Check the signal strength (RSSI) data during those periods. If the signal strength drops in condensing conditions, turn on the mirror heaters or boost the power delivered to the mirror heaters during those time periods.

### **Washer fluid used up too quickly:**

Check the washer mirror settings. Try lowering the signal strength threshold, setting the stop time close to the start time, or reducing the duration of the cleaning cycle.

Attach an auxiliary reservoir to the washer assembly.

**No methane data stream:**

If your computer goes to “sleep”, the methane graph will not update upon “waking up.” Click the “Clear Charts” button.

Be sure the “Pause/Resume” button has not been pressed.

**Methane density data near zero, negative, or otherwise unbelievable:**

Check the Diagnostics Page1 tab. If the graph does not make a nice bell curve shape, check the “Laser control:” in the Status frame. If the indicator is red, the reference signal is “unlocked.” Click the red indicator or press Ctrl +Alt +L to open the Laser Temperature Control window. Follow the steps described on page 7-3 to re-enable the line locking.

Check the zero and span using the procedure described on page 7-1.

If these do not work, contact LI-COR Biosciences.

**Instrument does not keep time when disconnected from power supply:**

The internal battery needs to be replaced. Contact LI-COR for details.





## Appendix D. Suppliers

The company names and contact information given below are the most current we have at the time of this printing. In some cases, the information may change without notice.

### Chemical Sources

Desiccant	LI-COR Part Number
Scrub Bottle Kit (1 pre-charged scrub bottle)	7700-950
Magnesium Perchlorate, 2 kg	9960-078

Additional Suppliers:

Fisher Scientific <a href="http://www.fishersci.com">www.fishersci.com</a> 800-766-7000 770-871-4500	VWR Scientific Products <a href="http://www.vwrsp.com">www.vwrsp.com</a> 800-932-5000 908-757-4045
Thomas Scientific <a href="http://www.thomassci.com">www.thomassci.com</a> 800-345-2100 856-467-2000	GFS Chemicals, Inc. <a href="http://www.gfschemicals.com">www.gfschemicals.com</a> 800-394-5501 740-881-5501
P.W. Perkins Co., Inc. <a href="http://www.pwperkins.com">www.pwperkins.com</a> 856-769-3525	LI-COR Biosciences 4421 Superior Street Lincoln, NE 68504 USA 800-447-3576 402-467-3576 <a href="mailto:envsales@licor.com">envsales@licor.com</a> <a href="http://www.licor.com">www.licor.com</a>

## Calibration Gases

### ***U.S. & International***

Scott Specialty Gases  
6141 Easton Road  
Plumsteadville, PA 18949  
Phone: 215-766-8860  
FAX: 215-766-0320  
[www.scottgas.com](http://www.scottgas.com)  
Check for local distributors

### ***U.S.***

Air Liquide America Specialty Gases LLC  
6141 Easton Road, Box 310  
Plumsteadville, PA 18949  
Phone: 800-217-2688  
FAX: 215-766-2476  
[solutions.center@airliquide.com](mailto:solutions.center@airliquide.com)  
[www.alspecialtygases.com](http://www.alspecialtygases.com) or [www.scottgas.com](http://www.scottgas.com)  
Check for local distributors

### ***Canada***

Air Liquide Canada Inc.  
1250 Rene-Levesque Boulevard West  
Suite 1700  
Montreal, PQ H38 5E6  
Phone: 800-217-2688  
FAX: 514-846-7700  
Email: [info.alc@airliquide.com](mailto:info.alc@airliquide.com)  
[www.specialtygas.ca](http://www.specialtygas.ca)

## Turck® Cables

Turck, Inc.  
 3000 Campus Drive  
 Minneapolis, MN 55441  
 Phone: 612-553-7300  
 FAX: 612-553-0708  
[www.turck.com](http://www.turck.com)

Turck Cables used with the LI-7700.

LI-COR p/n	Cable	Connector	Turck p/n
392-10108	Ethernet	8-pin male-male	RSS RSS841-*M
392-10107	Ethernet Adapter	8-pin female to RJ45	RKC RJ45 840-*M
392-10109	Analog In/Out	12-pin male	RSS 12T-*
392-10268	Serial	6-pin female to DB-9 female	RKC 6T-* DB9F/CS12317
392-10093	SDM Interface	4-pin male	RSS 4.4T-*
392-10094†	Power	4-pin female	RK4.41T-*/S529
392-10211	Washer Assembly Power Cable	4-pin male-male	PKG V-4M-* PKG V4M/S90

\* refers to cable length

† when ordering a power cable from LI-COR, request p/n 9975-030. Power cables provided by Turck may have bare leads; the brown and white leads connect to the negative terminal, and the blue and black connect to the positive terminal.

## Industrial Rated USB Flash Drives

Flash Drive Capacity	LI-COR Part Number
4 GB	616-10722
16 GB	616-10723

LI-COR Biosciences  
4421 Superior Street  
Lincoln, NE 68504 USA  
800-447-3576  
402-467-3576  
[envsales@licor.com](mailto:envsales@licor.com)  
[www.licor.com](http://www.licor.com)

Delkin Devices, Inc.  
13350 Kirkham Way  
Poway, CA 92064-7117  
Phone: 800-637-8087  
[www.delkin.com](http://www.delkin.com)

## Mounting Hardware

Nurail  
Metropolitan Pipe & Supply Co.  
303 Binney St.  
Cambridge, MA 02142 USA  
Phone: 1-800-638-7473  
Fax: 617-354-3869  
[www.nurail.com](http://www.nurail.com)

Diamond Aluminum Company  
119 E. Galbraith Road  
Cincinnati, OH 45216  
Phone: 513-821-1080  
Fax: 513-821-0121  
[info@diamond-aluminum.com](mailto:info@diamond-aluminum.com)  
[www.diamond-aluminum.com](http://www.diamond-aluminum.com)

# Warranty

---

For the most up to date warranty information, see the Standard Terms and Conditions of Sale at <http://www.licor.com/corp/terms.jsp>

Each LI-COR, Inc. instrument is warranted by LI-COR, Inc. to be free from defects in material and workmanship; however, LI-COR, Inc.'s sole obligation under this warranty shall be to repair or replace any part of the instrument, which LI-COR, Inc.'s examination discloses to have been defective in material or workmanship without charge and only under the following conditions, which are:

1. The defects are called to the attention of LI-COR, Inc. in Lincoln, Nebraska, in writing within one year after the shipping date of the instrument.
2. The instrument has not been maintained, repaired, or altered by anyone who was not approved by LI-COR, Inc.
3. The instrument was used in the normal, proper, and ordinary manner and has not been abused, altered, misused, neglected, involved in an accident or damaged by act of God or other casualty.
4. The purchaser, whether it is a DISTRIBUTOR or direct customer of LI-COR or a DISTRIBUTOR'S customer, packs and ships or delivers the instrument to LI-COR, Inc. at LI-COR Inc.'s factory in Lincoln, Nebraska, U.S.A. within 30 days after LI-COR, Inc. has received written notice of the defect. Unless other arrangements have been made in writing, transportation to LI-COR, Inc. (by air unless otherwise authorized by LI-COR, Inc.) is at customer expense.
5. No-charge repair parts may be sent at LI-COR, Inc.'s sole discretion to the purchaser for installation by purchaser.
6. LI-COR, Inc.'s liability is limited to repair or replace any part of the instrument without charge if LI-COR, Inc.'s examination disclosed that part to have been defective in material or workmanship.

There are no warranties, express or implied, including but not limited to any implied warranty of merchantability or fitness for a particular purpose on underwater cables or on expendables such as batteries, lamps, thermocouples and calibrations.

Other than the obligation of LI-COR, Inc. expressly set forth herein, LI-COR, Inc. disclaims all warranties of merchantability or fitness for a particular purpose. The foregoing constitutes LI-COR, Inc.'s sole obligation and liability with respect to damages resulting from the use or performance of the instrument and in no event shall LI-COR, Inc. or its representatives be liable for damages beyond the price paid for the instrument, or for direct, incidental or consequential damages.

The laws of some locations may not allow the exclusion or limitation on implied warranties or on incidental or consequential damages, so the limitations herein may not apply directly. This warranty gives you specific legal rights, and you may already have other rights, which vary from location to location. All warranties that apply, whether included by this contract or by law, are limited to the time period of this warranty which is a twelve-month period commencing from the date the instrument is shipped to a user who is a customer or eighteen months from the date of shipment to LI-COR, Inc.'s authorized distributor, whichever is earlier. This warranty supersedes all warranties for products purchased prior to June 1, 1984, unless this warranty is later superseded.

DISTRIBUTOR or the DISTRIBUTOR'S customers may ship the instruments directly to LI-COR if they are unable to repair the instrument themselves even though the DISTRIBUTOR has been approved for making such repairs and has agreed with the customer to make such repairs as covered by this limited warranty.

Further information concerning this warranty may be obtained by writing or calling the Warranty manager at LI-COR, Inc.

**IMPORTANT:** Please return the User Registration Card enclosed with your shipment so that we have an accurate record of your address. Thank you.

# Index

## A

About LI-7700 PC Application icon, 2-2

Analog Input/Output Cable, 3-3

analog inputs

Analyzer Interface Unit

configuring, 3-15

electrical connection notes, 3-18

pin assignments/wire colors, 3-17

time delays, 3-19

LI-7700

Auxiliary Sensor Interface jumper, 2-21

connector, 1-8

pin assignments/wire colors, 2-22

analog outputs

about, 3-26

pin assignments/wire colors, 3-27

Analyzer Interface Unit, 3-1

connecting an LI-7700 to, 3-7

connection panel, 3-4

Apply button, 2-4

Auxiliary Sensor Interface, 1-5

connecting, 2-23

terminals, 2-21

auxiliary sensors. *see* analog inputs

## B

bandwidth, 2-18

## C

calibration

certificate, 1-4

gas suppliers, 8-12

setting the span, 7-2

setting the zero, 7-1

shroud, 1-4

Cancel button, 2-4

charts, 2-4

clock. *see* time

CO<sub>2</sub>/H<sub>2</sub>O Analyzer, using the LI-7700 with, 3-9

configuration file

creating, 2-19

implementing, 2-19

Configure Auxiliary Inputs icon, 2-25, 3-15

Configure LI-7550 Outputs icon, 3-24

Connect icon, 1-11

connection panel, 1-8

## D

data, 4-1

data file

data header, 4-2

diagnostics header, 4-4

file header, 4-1

data logging. *see* logging data

data storage capacity. *See* USB flash drives

date. *see* time

desiccant

changing, 8-4

suppliers, 8-11

diagnostics. *see* data file

laser temperature control, 7-3

## E

eddy covariance method, 5-2

equation summary, 6-1

equivalent pressure,  $P_e$ , 6-7

Ethernet

cables, 1-3

connection, 1-10, 3-2

connection location, 1-8, 3-4



output. see logging data PC/Network

## F

factory reset, 7-2  
files. see data  
Finder Application, LI-7700, 7-8  
flash drive. See USB  
flux computation  
    about, 5-2  
fuse  
    LI-7550, 8-7  
    LI-7700, 8-7

## G

GHG-1 or GHG-2, 3-9  
grammar  
    about, 7-14  
    change settings, 7-24  
    configuration file, 7-21  
    element descriptions, 7-15  
    full XML file, 7-15  
    request a data record, 7-24  
    sending commands, 7-24  
graphs. See charts  
grounding, 2-29, 3-29

## H

hardware suppliers, 8-14  
Heater, 2-3  
heater controls. see mirror heater controls  
Herriott cell, 1-2

## I

inputs  
    LI-7700 analog, 2-20  
IPv6 on Windows XP, 7-7

## L

Laser Control, 2-3  
laser temperature control, 7-4  
LI-7200. see CO<sub>2</sub>/H<sub>2</sub>O Analyzer  
LI-7500A. see CO<sub>2</sub>/H<sub>2</sub>O Analyzer  
LI-7550. see Analyzer Interface Unit  
line broadening mechanisms, 6-2  
line lock  
    about, 7-4  
    automatic, 7-7  
    manual, 7-5  
logging data  
    PC/Network, 2-6  
    USB, 3-12

## M

Manual Controls  
    about, 2-9  
mirror cleaner. see Spin Motor Control  
mirror cleaner nozzle  
    attaching, 2-30  
mirror heater controls, 2-10  
    finding the best settings, 2-11  
mirrors  
    cleaning, 1-12  
mounting  
    7550-101 Auxiliary Sensor Interface, 2-29  
    LI-7550 Analyzer Interface Unit, 3-29  
    LI-7700, 2-27  
    washer reservoir, 2-31

## N

New Instrument Configuration, 2-19

## O

OK button, 2-4  
Open Configuration File icon, 2-19

Optics RH, 2-3, 8-4  
output rate, 2-18

## P

pin assignments  
Analyzer Interface Unit, 3-5  
polynomials, 2-25  
power cable  
LI-7550 Analyzer Interface Unit, 3-2  
LI-7700 Methane Analyzer, 1-3  
power connection, 1-9  
power on  
LI-7550, 3-6  
LI-7700, 1-9  
power requirements, 8-3  
PTP, 2-17

## R

radiation shield, 1-7

## S

Save Instrument Configuration icon, 2-2, 2-19  
SDM  
cable, 3-3  
configuring, 3-21  
modes, 3-22  
output, 3-21  
pin assignments, 3-3, 3-5  
serial  
cable connection, 3-3  
configuring, 3-25  
set point, 3-26  
settings, 2-6  
Signal Path is Clear, 2-3  
software CD, 1-9  
span. see calibration  
spares kit

Analyzer Interface Unit, 1-6  
Auxiliary Sensor Interface, 1-5  
LI-7700 Analyzer, 1-3  
specifications  
LI-7550 Analyzer Interface Unit, 8-2  
LI-7700, 8-1  
Spin Motor Control  
about, 2-12  
examples, 2-14  
indicator, 2-3  
splitting files, 2-7  
status columns  
header, 4-6  
logging, 2-7  
Steinhart equation, 2-25  
suppliers, 8-11

## T

temperature dependence of absorption line  
strength, 6-2  
temperature range setting, 2-8  
theory of operation, 6-1  
thermocouple  
changing, 8-6  
data, 4-3  
inputs, 2-24  
LI-7700, 1-7  
time  
about, 2-16  
setting  
Analyzer Interface Unit, 3-20  
LI-7700, 2-16  
stamp, 4-3  
troubleshooting, 8-8  
Turck cables, 8-13

## U

USB data logging. See logging data  
USB flash drives

- about, 3-14
- ejecting, 3-13
- formatting, 3-14
- storage capacity, 3-14
- suppliers, 8-14

## **V**

- vibrations, 2-27

## **W**

- Warranty

- washer
  - about, 1-4
  - cleaning solution, 1-12
- waveforms, 7-3
- Waveforms icon, 2-2
- wavelength modulation spectroscopy, 6-4

## **Z**

- zero. see calibration
- zero flux, 5-19

***LI-COR***<sup>®</sup>

Biosciences

*Measuring Change in a Changing World*<sup>®</sup>

LI-COR, Inc. • Environmental  
4647 Superior Street • P.O. Box 4425 • Lincoln, Nebraska 68504 USA  
Phone: 402-467-3576 • FAX: 402-467-2819  
Toll-free 1-800-447-3576 (U.S. & Canada)  
envsales@licor.com  
www.licor.com