

LI-8100A Automated Soil CO₂ Flux System

Survey, Long-Term, and
Multiplexed Measurements



LI-COR®

Field Guide

Table of Contents

| | |
|--|----|
| LI-8100A System Definitions..... | 2 |
| Single Chamber Software Configuration | 4 |
| Multiplexer Software Configuration | 5 |
| Single Chamber Example..... | 6 |
| Using the Auxiliary Sensor Interface..... | 8 |
| Connecting Soil Moisture Probes to the Auxiliary Sensor Interface | 13 |
| Connecting the Soil Temperature Probe to the Auxiliary Sensor Interface..... | 16 |
| Multiplexed Example | 17 |
| LI-8150 Display..... | 20 |
| Cable Connections..... | 21 |
| Performing a Leak Test | 24 |
| Leak Test using Windows Software | 26 |
| Leak Test using a PDA..... | 27 |
| Changing the 8100-104/C Chamber Open Position | 28 |
| LI-8150 Maintenance and Repair | 30 |
| Automatic Restart Function..... | 34 |
| LI-8100A System Power Requirements..... | 36 |
| Wireless Troubleshooting..... | 37 |
| LI-8100A System Part Numbers..... | 38 |
| Spare Parts Kits..... | 39 |
| LI-8100/A and LI-8150 Measurement Checklist..... | 41 |

LI-8100A System Definitions

Observation Length. Time from the instant the chamber closes until the instant it begins to open again, including the specified dead band period. Units; minutes, seconds.

Deadband. The time period that starts when the chamber closes completely, and continues until steady mixing is established and the measurement begins.

Observation Count. The number of times at which to repeat observations under the same set of measurement parameters. Used only in Single-Chamber mode.

Observation Delay (Pre-purge).

When making repeated measurements, a delay is required to allow the chamber air to return to ambient conditions before beginning the next observation cycle. This delay begins immediately in Single-Chamber mode, in which case setting an appropriate Purge Time is adequate. In Multiplex mode, the Observation Delay is the time before the next chamber begins its measurement.

Post-Purge Time. Similar to an Observation Delay, this is the amount of time during which air continues to flow through the chamber as it

Survey Chambers

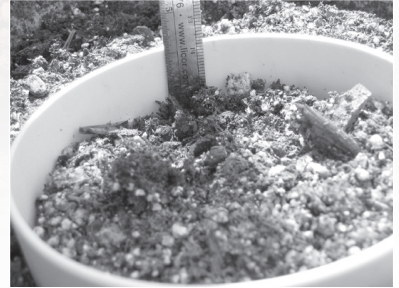

Figure 1. The chamber offset for the Survey Chambers is measured by the distance between the soil surface and the top of the soil collar.

begins to open. Purging is necessary to flush the air lines of high CO₂ after a measurement. In Single-Chamber mode, after the first measurement is complete, Observation Delay and Purge Time are additive.

Repeat Function. Allows the user to repeat the defined protocol at a regular clock interval. For example, you might set an Observation Length of 2 minutes, a Deadband of 30 seconds, and an Observation Delay of 1 minute, and then repeat this protocol every 30 minutes for 14 days.

Chamber Offset. The distance (cm) between the soil surface and the top of the soil collar. The Offset is dependent upon the depth that the collar is inserted into the ground. The soil CO₂ flux measurement requires an accurate estimate of the Total System Volume. The Offset is measured differently depending on which chamber is being used.



Figure 2.



Figure 3. Long-term Chambers. Measure the distance from the soil surface to the top of the soil collar (Figure 2), and then subtract the distance between the upper edge of the chamber base plate and the top of the soil collar (Figure 3).

Single Chamber Software Configuration

Typical Measurement

Observation Length =
2 minutes

Deadband =
30 seconds

Observation Delay or
Purge Time to total
45 seconds

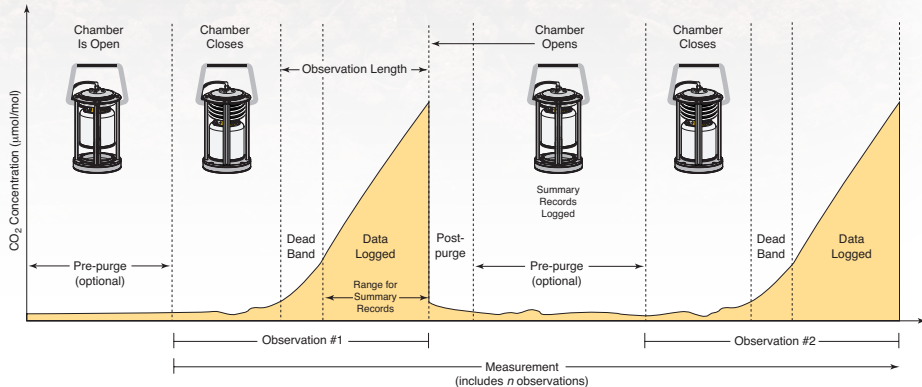

Multiplexer Software Configuration

Typical Measurement

Observation Length for each chamber = 2 minutes

Deadband = 30 seconds

Observation Delay or Purge Time to total 45 seconds

Choose a port sequence

Repeat the sequence at a specified interval

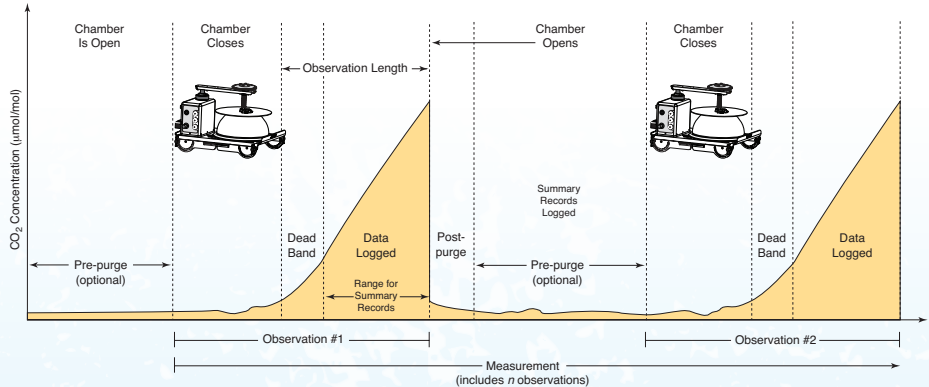

Single Chamber Example

Connecting the Chamber to the Analyzer Control Unit

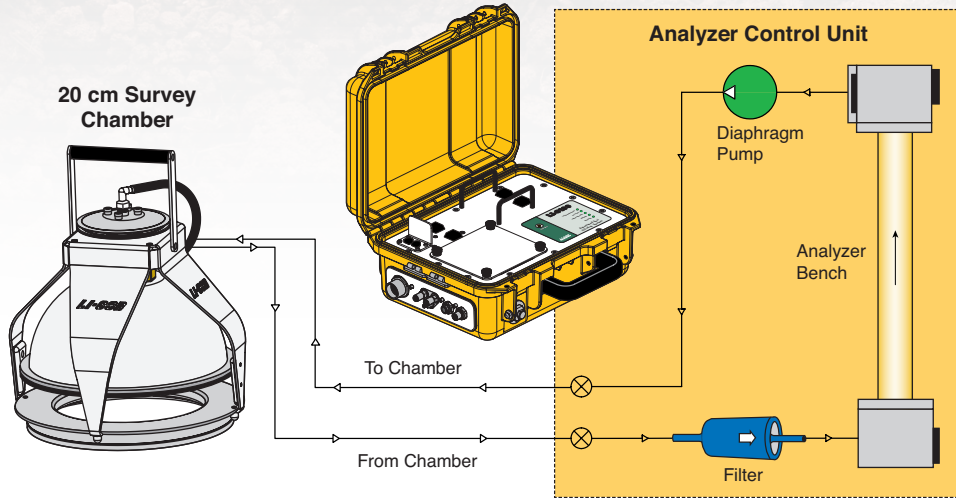

There are three hoses connected to the 20 cm Survey Chamber: air to the chamber, air returning from the chamber to the Analyzer Control Unit, and air that drives the bellows. These hoses are connected to the side panel of the Analyzer Control Unit, as shown in Figure 4. The Air In hose has a male fitting, and the Air Out hose has a female fitting. Note that one of the hoses has a piece of

black shrink wrap; this hose attaches to the Air In fitting on the Analyzer Control Unit. The bellows hose has a male fitting, and attaches to the port marked Bellows on the Analyzer Control Unit. Insert the hoses until the fittings snap into place. To remove the hoses, slide the collar on the fittings and pull straight out.



Figure 4. Analyzer Control Unit hose connections.

Using the Auxiliary Sensor Interface

The Auxiliary Sensor Interface attaches to the side of the Analyzer Control Unit and allows for connection of your choice of sensors, or an alternative power supply. The Auxiliary Sensor Interface is O-ring sealed, has connections for up to 4 thermocouples (types E, J, or T), and has 4 general purpose input voltage channels, any of which can be configured to measure a soil moisture probe. Sensors can be powered externally or by the LI-8100 with a constant 5 VDC source. The Auxiliary Sensor Interface also has a 12-28 VDC input (3A maximum) for use with external power.

Note that on Type E, J, or T thermocouples, the red wire is negative. On the 8100-201 Thermocouple Probe, the red wire is negative, and the purple wire is positive.



Auxiliary Sensor Interface and connector.

Auxiliary Sensor Interface Terminals

Loosen the 4 Phillips head screws in each corner of the Auxiliary Sensor Interface module to remove the top cover. The interior of the interface appears as shown at right.

Note that there are 2 terminal strips, with connections as follows:

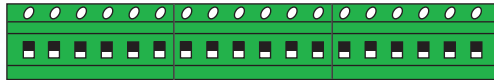

+ GND + GND + GND + GND GND GND + T1 + T2 + T3 + T4

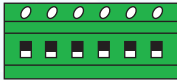

+ V IN + V OUT + V OUT
10.5-28VDC 5VDC 5VDC
3A MAX 30mA 30mA
SWITCHED

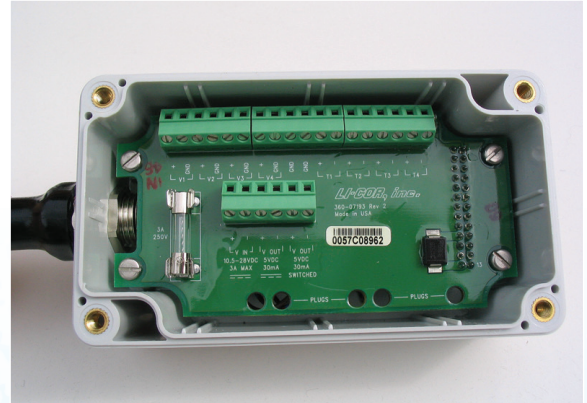

Auxiliary Sensor Interface interior.

Connecting Sensors to the Auxiliary Sensor Interface

There are 5 strain relief “gland” type plugs on the Auxiliary Sensor Interface top cover, through which the sensor or power supply wires pass, after which the wires are connected to the appropriate screw terminals. To attach your sensor(s) or power supply to the Auxiliary Sensor Interface, follow these steps:

1. Remove the Phillips head screw in each of the 4 corners of the Auxiliary Sensor Interface module and remove the top cover.
2. Remove the cap from any of the 5 gland plugs by turning counterclockwise.
3. Pass the wires through the top of the plug cap first, and then through the gland plug. Screw the plug cap slightly, but don't tighten yet.

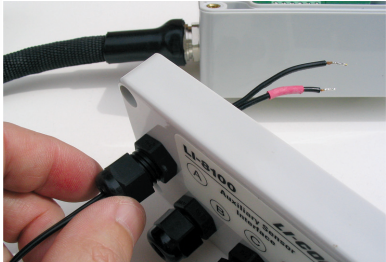
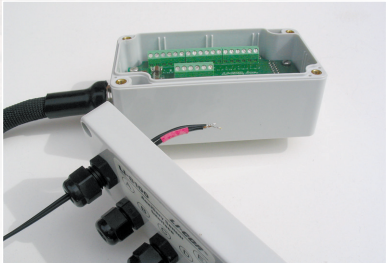

4. Use a small flathead screwdriver to loosen the appropriate screw terminal, and insert the wire leads into the terminal strip. Tighten the screw terminals. Make a note of which plug the wires are passing through (e.g. A, B, C, D, or E), and to which terminal the wires are connected (e.g. A/T1, B/V3, etc.). This information will be needed later when you enter the sensor calibration coefficients into software.

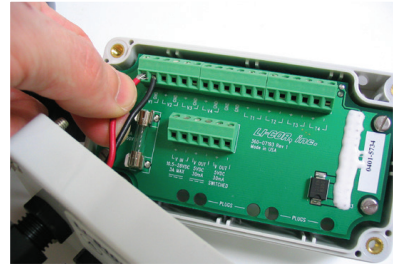

5. Pull lightly on the wires to remove excess wire from inside the interface, re-attach the interface top cover, and tighten the gland plug cap.



Connecting Sensors to the Auxiliary Sensor Interface (cont.)

- When you have finished installing all of your sensors and/or a power supply, attach the Auxiliary Sensor Interface cable connector to the connector on the side panel of the Analyzer Control Unit labeled Aux. Sensor Interface. The Sensor Interface module has metal fittings on the back that snap into the brackets above the side panel connectors for transporting the unit.
- There are 10 EPDM type plugs that can be inserted into unused gland plugs on the Auxiliary Sensor Interface; the plugs prevent water, insects, dirt, etc. from entering the interface box. Remove the top cover and insert the narrow end of the plug through the back of the gland plug(s) and tighten the plug cap(s) (below). The plugs should always be inserted when there are gland plugs that do not have wires inserted through them.
- Note that there is a length of Santoprene tubing in the Auxiliary Sensor Interface spares kit. This tubing can be cut to length and used for small gauge wires that may not be able to be tightened sufficiently with the gland plugs. It can also be used for oddly shaped wires that can be difficult to seal with the gland plug caps.



Connecting Soil Moisture Probes to the Auxiliary Sensor Interface

The ECH₂O Model EC-5 soil moisture probe (Decagon Devices, Inc., Pullman, WA) is a 5 cm (2") dielectric sensor that measures volumetric water content of the soil. The probe has a stereophone jack at its base; an adapter plug is included (p/n 436-08586) that contains a 3-wire cable for connection to the Auxiliary Sensor Interface. Voltage channels 1-4 (V1-V4) can be used with the ECH₂O soil moisture probe; the soil probe must be set up in software. The 3-wire adapter cable has red, bare (ground, unshielded), and white wires that are connected to V4(+), V4(-), and V OUT 5VDC SWITCHED(+), respectively, as shown at the right.

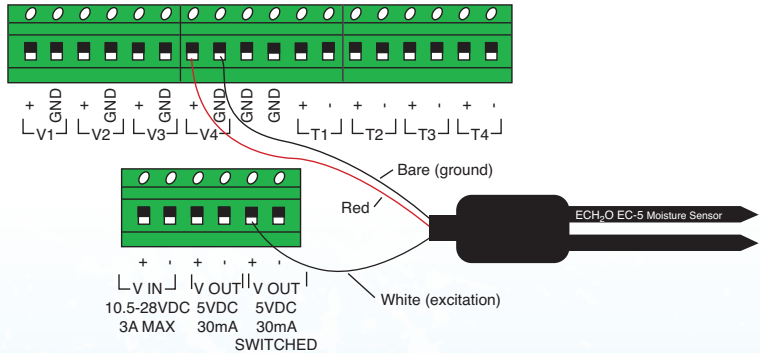

Connecting Soil Moisture Probes to the Auxiliary Sensor Interface (cont.)

The 8100-204 Theta soil moisture probe (Delta-T Devices Ltd., Cambridge, England) is terminated with bare wires for connection to the Auxiliary Sensor Interface. Voltage channels 1-4 (V1-V4) can be used with the Theta soil moisture probe; the soil probe must be set up in software. The wire connections are shown at right.

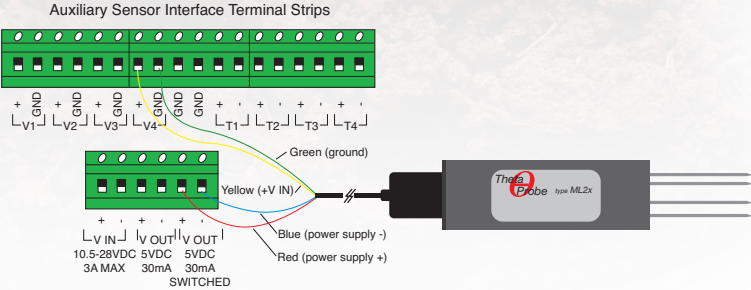

Slope and offset coefficients for linear input devices need to be entered into the Windows Application Software and/or the Interface Software for the PDA before using the soil probe. Note that the 8100-204 and 8150-204 use different linearization coefficients, based on the organic content of the soils into which the probe is inserted. In general, if the soil is classified as a Mineral soil, with < 7% organic content, the probe uses one set of coefficients, and if the soil is classified as an Organic soil, with > 7% organic content, the probe uses a second set of coefficients, as follows:

| Soil type | Use for organic contents: | Bulk density range (g/cm ³) | Use for bulk densities | Slope | Offset |
|-----------|---------------------------|---|-------------------------|-------|--------|
| Mineral | < 7% | 1.25 - 1.5 g/cm ³ | > 1.0 g/cm ³ | 0.529 | -0.060 |
| Organic | > 7% | 0.2 - 0.7 g/cm ³ | < 1.0 g/cm ³ | 0.577 | -0.026 |

It is possible to perform soil-specific calibration of the soil moisture probe to obtain linearization coefficients; refer to the ThetaProbe ML2x instruction manual for more information.

Connecting the Soil Temperature Probe to the Auxiliary Sensor Interface

The 8100-203 Soil Temperature Thermistor Probe kit consists of a Soil Temperature Thermistor Probe (p/n 8150-203) and a Probe Adapter (p/n 9981-150) that mates to the Soil Temperature Thermistor Probe; the Probe Adapter contains a resistor that allows the 8150-203 Soil Temperature Thermistor Probe to be used with the Auxiliary Sensor Interface on the LI-8100/A Automated Soil CO₂ Flux System. The 8100-203 is terminated with bare wires for connection to the Auxiliary Sensor Interface; the soil temperature probe must be set up in software. The wire connections are shown below.

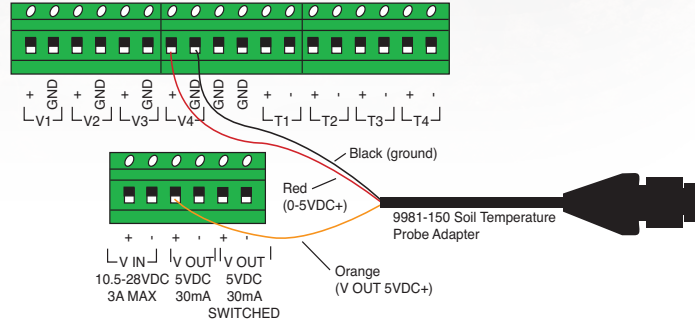

Multiplexed Example

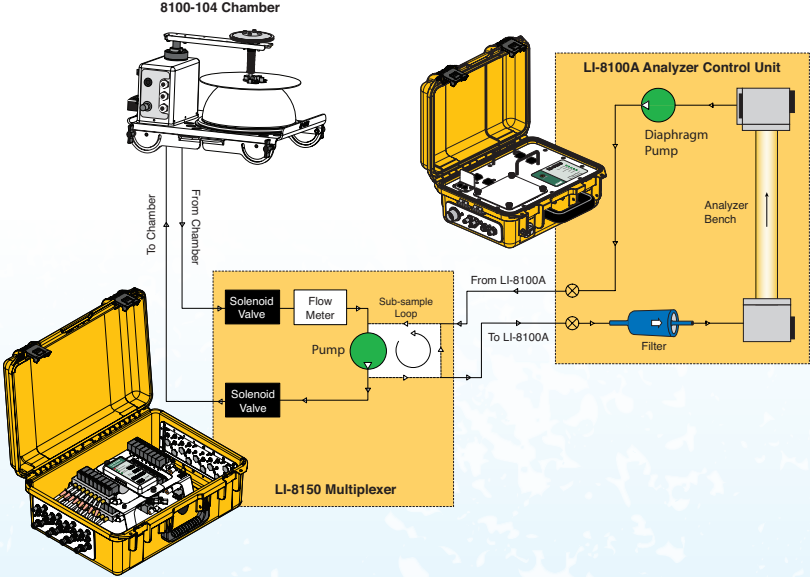

The above block diagram shows the direction of flow, and the major components contained in the pneumatic circuit. Solenoid valves are used to control flow to and from one chamber at a time (there is a separate valve for inlet and outlet). Thus, the 8-port multiplexer has 16 solenoids, and the 16-port multiplexer has 32 solenoids. Sample gas from the chamber is filtered as it enters the pneumatic circuit;

it is filtered again in the LI-8100A before it is measured by the IRGA. A diaphragm pump is used to circulate the sample gas to and from the multiplexer and the selected chamber. A flow sensor measures the approximate flow rate in the 'chamber loop' (between 1.5 and 3.5 lpm in normal operating conditions). The flow rate is adjustable in software. The pump also circulates flow in a 'sub-sampling loop', as it is in-line with both

parallel loops. Flow restrictors in the 'sub-sampling loop' restrict flow in comparison to the 'chamber loop' to control the pressure in the LI-8100A IRGA. The LI-8100A, in turn, samples air from the 'sub-sampling loop' using its own pump. The LI-8100A bellows pump circuit is used to pressurize each chamber to test for leaks.

On either side of the LI-8150 case are connections for up to 8 chambers. The left side has only chamber connections; the right side (not pictured) also has power and LI-8100A connections. The raised platform in the case contains the On/Off switch and central Control Panel (below), which provides a display of the active chamber and valve. A Chamber Actuator Button is also located on the raised platform; pressing this button closes all attached chambers (4 at a time), which is useful when preparing the chamber(s) for transport. The plate under the raised panel has a small access panel that can be removed to access the fuses.

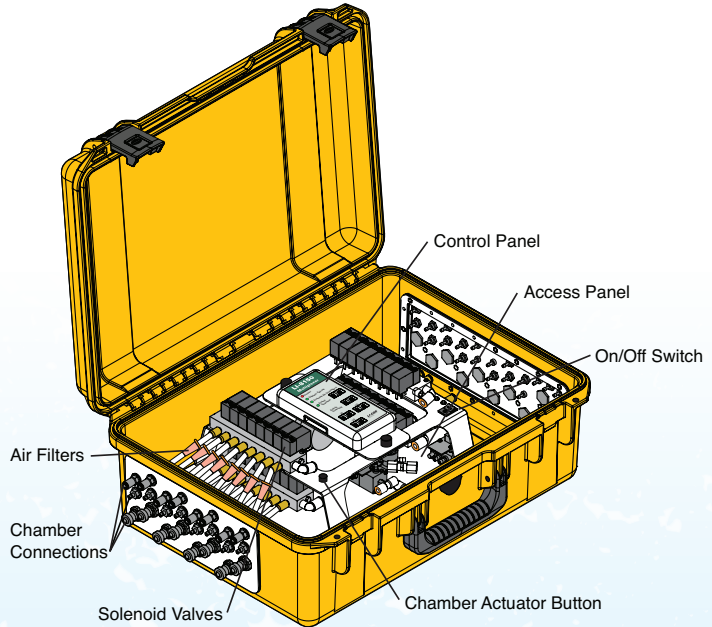

LI-8150 Multiplexer

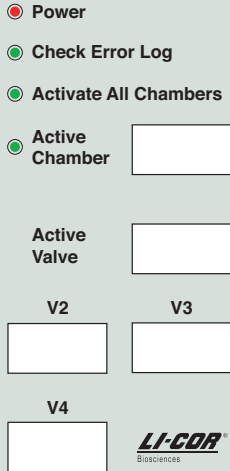

Power – Illuminates when power is applied to the instrument, and the power switch is turned On.

Check Error Log – Illuminates when an error condition is detected (e.g. a chamber failed to close, flow rate is too low, etc.). The Error Log can be viewed in the Windows application software, under the View Menu, and in the PDA software, by pressing the “E” indicator when present.

Activate All Chambers – Illuminates when Chamber Actuator Button is pressed. All connected chambers will close in series (4 at a time); (1-4), (5-8), (9-12), and (13-16).

Active Chamber – Displays chamber that is currently performing a measurement.

Active Valve – Displays currently active (open) solenoid valve. When a measurement is being performed, this will always match the Active Chamber. When the instrument is idle, however, a valve can be operated independent of the chamber(s).

V2-V4 – Shows the port from which the indicated voltage output is coming.

Cable Connections

LI-8100A

There is a panel for connecting the RS-232, chamber, and Auxiliary Sensor Interface cables on the left side of the LI-8100A Analyzer Control Unit. These connectors have slightly different uses when the LI-8150 Multiplexer is connected to the Analyzer Control Unit. The LI-8100A side panel appears as shown in Figure 5.

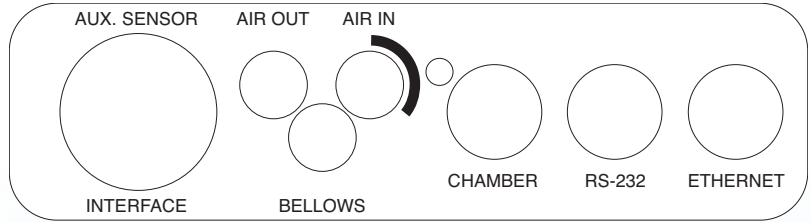

Figure 5. LI-8100A Analyzer Control Unit cable connection panel.

There are two hose/cable bundles included with the LI-8150: the yellow cable with large bulkhead connectors on both ends connects to the port labeled Aux. Sensor Interface on the LI-8100A, and to the port labeled LI-8100 on the LI-8150. The second hose bundle has three air hoses and an electronic cable. These hoses are connected to the side panel of the Analyzer Control Unit, as shown at right. The hose for Air In has a male fitting and the hose for Air Out has a female fitting. Note that one of the hoses has a piece of black shrink wrap; this hose attaches to the Air In fitting on the Analyzer Control Unit. The bellows hose has

a male fitting, and attaches to the port marked Bellows on the Analyzer Control Unit. Insert the hoses until the fittings snap into place. To remove the hoses, slide the collar on the fittings; the collar on the bellows and Air In fittings slide toward the Analyzer Control Unit, and the collar on the Air Out fitting slides away from the Analyzer Control Unit.

Note that the fittings on the side panel have fine threads. Make sure there is no debris on the fittings before attaching the connectors, as the threads can be damaged. Cover the connectors with the attached connector dust caps whenever the connectors are not being used.

The yellow circular connector bundled with the air hoses is attached to the Chamber fitting. Note that this fitting is indexed; you may have to rotate it until it slips into place before tightening.



Cable Connections

LI-8150

Attach the large bulkhead connector to the port labeled LI-8100. Attach one end of the power cable to the connector labeled PWR.



Attach the bulkhead connector and power cable.

The hose for the pump (labeled P) has a male fitting. The hose for Air Out (labeled O) also has a female fitting; this hose has a piece of black shrink wrap. The Air In hose has a female fitting, and attaches to the port marked I. Insert the hoses until the fittings snap into place. To remove the hoses, slide the collar on the fittings. Lastly, attach the round control cable to the connector labeled CTRL.



Attach the air hoses and control cable.

Performing a Leak Test

The LI-8150 Multiplexer utilizes a large amount of tubing, particularly when extension tubes are used between the Multiplexer and the soil chambers. A routine has been developed that allows the user to test for leaks in the system. Each port can be tested individually; the soil chamber is isolated and is not a part of the leak test. To perform the leak test, the bellows circuit in the LI-8100A (not used during normal operation for the Long-Term chambers) is used to evacuate the system. The IRGA pressure is then monitored to determine the leak

rate of the system. Upon completion of the leak check on each port, the system is purged to allow the next port to be evacuated.

The leak test requires that: a) each multiplexer port is sealed to form a closed loop, usually by disconnecting the extension tubing at the chamber end and mating the male and female connectors to each other, and b) one port is left open to allow the system purge.

Note that the Multiplexer can be tested for system leaks independent of any extension tubing; the

leak test will test for integrity of the solenoids and internal tubing only, as well as the connection between the LI-8100A and the Multiplexer. A small fixture (p/n 9981-142) consisting of a short piece of tubing, and a male and female connector, is included in the spares kit, which forms a closed loop between the air input and output ports (Figure 9 below). The fixture is connected to each port before performing the leak test on that port; only one port can be tested at a time.



Figure 6. In the absence of extension tubing, the leak test fixture is attached between the air inlet and outlet ports (port #14 shown).

Follow these steps to perform a leak test:

1. For each port to be tested, disconnect the extension tubing at the chamber end, and mate the male and female connectors together to form a closed loop. Alternatively, connect the tubing fixture (p/n 9981-142) between the air inlet and air outlet ports on the Multiplexer side panel, in the absence of the optional cable/hose extension tube assembly.
2. Make sure that at least one port is left open; you can disconnect the tubing at the chamber end without mating the connectors, or simply disconnect at the Multiplexer side panel. Thus, the greatest number



Mate the male and female connectors at the chamber end of the extension tubing.

- of ports that can be checked at one time is 7, with an 8-port system, or 15, with a 16-port system. The open port will need to be checked for leaks after completion of the other ports' test.
3. Choose Manual Controls from the Utilities menu in Windows or Palm software.

Windows:

- Click on the Leak Test tab in the Manual Controls dialog.
- Enable the check boxes next to the ports to be tested. Choose a purge port to be left open. Enable the '8100 to Mux' check box to test the air lines between the LI-8100 and the Multiplexer (Port 0).
- Click on the Run Test button. Each selected port will be tested in sequence. The results of each test are displayed after the port check is completed.

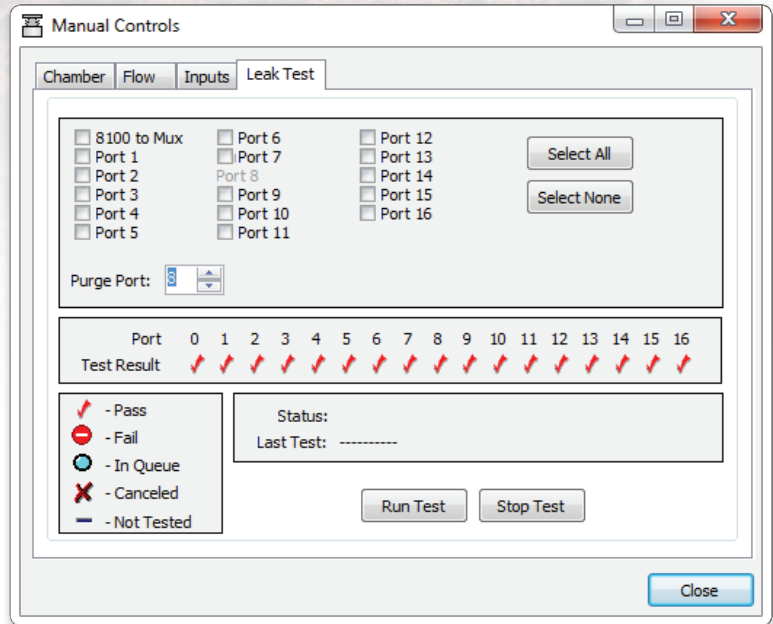

Hand-held Device:

- a. Tap on Leak Test in the Manual Controls page.

| | Value | Port | Action |
|---------------------|-------|------|-----------|
| <i>i</i> Chamber: | Open | 7 | Close |
| <i>i</i> Gas: | 1 | 8 | CO2 |
| <i>i</i> V2: | 19 | 9 | |
| <i>i</i> V3: | 20 | 10 | |
| <i>i</i> V4: | 21 | 11 | |
| <i>i</i> Pressure: | 6 | | Leak Test |
| <i>i</i> 8100 Flow: | Low | | On |
| <i>i</i> Port Flow: | 5 | | On |

- b. Enable the 'Include LI-8100 to Multiplex lines' box to test the air lines between the LI-8100A and the Multiplexer. Tap on the Port Sequence field.

Manual Controls Perform Leak Test

Port Sequence: 1,2,3,4,5,...2,13,14,15

Include LI-8100 to Multiplex Lines

i Last Executed: 2011-11-28 12:38:29

i ACU: x

| | | |
|---------------|----------------|----------------|
| <i>i</i> 1: x | <i>i</i> 7: x | <i>i</i> 13: x |
| <i>i</i> 2: x | <i>i</i> 8: x | <i>i</i> 14: x |
| <i>i</i> 3: x | <i>i</i> 9: x | <i>i</i> 15: x |
| <i>i</i> 4: x | <i>i</i> 10: x | <i>i</i> 16: x |
| <i>i</i> 5: x | <i>i</i> 11: x | |
| <i>i</i> 6: x | <i>i</i> 12: x | |

Start

- c. Tap Test next to the ports to be tested. Choose a purge port to be left open. Tap Send Update. The results of the test are shown in the Leak Test page.

Leak Test Select Ports To Test

Purge Port: 16

<Test> Port 1

<Test> Port 2

<Test> Port 3

Test Don't Test

Test All Test None

Send Update

Changing the 8100-104/C Chamber Open Position

The default open position is approximately 180° from the closed position, as shown below.

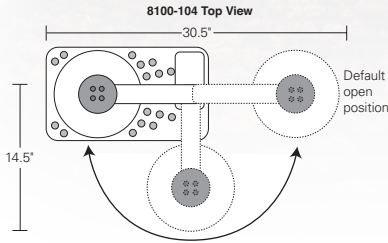

There are, however, five additional open positions that can be programmed using the Open/Close button on the chamber control panel. This can be useful for areas where the terrain, or obstructions, don't permit the full 180° of movement. To change the open position:

1. Press and hold the Open/Close button for 5 seconds. Wait a few moments while the chamber positions itself.
2. Press the Open/Close button one time to move the chamber to its first open position (#5 in the diagram below). Continue to press the button one time to move the chamber to each of the other five open positions.
3. When the chamber is in the desired open position, hold the Open/Close button for 5 seconds again; the chamber will "remember" this position until it is reprogrammed.

Press the Open/Close button twice in quick succession to “park” the chamber; the chamber raises slightly to prevent compression of the chamber gasket.

IMPORTANT! We recommend that you “park” the chamber before transport or long-term storage of the chamber.

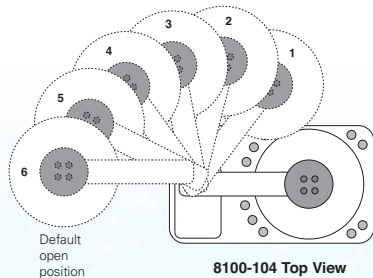

LI-8150 Maintenance and Repair

The LI-8150 Multiplexer is designed to require little or no routine maintenance. Most of the LI-8150 components are modular, and are designed to be easily replaced should the need arise. The following discussion describes basic maintenance and repair of user-replaceable items; contact LI-COR for information on repair of items not described below.

Fuses

There are two fuses on the LI-8150 main circuit board that protect the LI-8100A and LI-8150 power supplies. Spare fuses can be found in the LI-8150 spares kit. The fuses are located under the access panel at the front edge of the white lower plate assembly, as shown below. The proper fuse sizes are labeled on

the circuit board; the leftmost fuse protects the LI-8100A power supply (3A Fast 250V 5x20, p/n 439-04215), and the rightmost fuse protects the LI-8150 power supply (4A Fast 125V 5x20, p/n 439-08516). If the LI-8150 and/or LI-8100A fail to power up, check to see if either of these fuses has blown. Loosen the thumbnuts on the access panel and lift off to access the fuses.

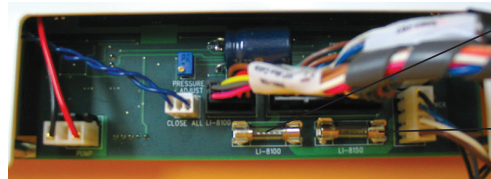

LI-8100A fuse:
3A Fast 250V 5x20. p/n 439-04215

LI-8150 fuse:
4A Fast 125V 5x20. p/n 439-08516

Tubing

The urethane tubing used for air connections within the LI-8150 is 1/8" ID x 1/4" OD; a 3' length of this tubing can be found in the spare parts kit under p/n 222-00303. If any of the internal tubing should become clogged or otherwise damaged, simply remove it by pressing in on the orange quick-connect fittings, cut a new piece of the same length, and replace.

Air Filters

The air filters are located on the air lines connected to each of the eight

(or sixteen) air input ports. The filters are translucent to more easily see dust and dirt buildup. Check the filters periodically (yearly or more often, depending on operating environment). Replace the filters when they become dirty, or if low, or no, flow rates are present on the associated chamber. A filter kit (8 each) can be found in the spares kit under p/n 8150-909; additional kits can be ordered from LI-COR.

Remove dirty or damaged filters by pressing on the quick-connect fittings and pulling the tubing straight out; discard the tubing and old filter.

Note the orientation of the new filter; the arrow pointing toward the wider end of the filter should point toward the solenoids. Attach the tubing near the solenoid first. The tubing on the other end of the filter is longer than is required; route the tubing toward the connector on the Multiplexer case, leaving a bit of slack, and cut to length.



Attach tubing here first

Air Filters (cont.)

Note there are two blue Balston type filters that filter incoming air to prevent clogging of the flow restrictors in the flow meter (Figure 7). Replace annually; spare filters can be obtained from LI-COR under

part number 300-01961. Note the orientation of the arrows on the filters in the figure below. Press in on the orange ring(s) on the quick connect fittings to remove the filters.

Air Pump

The diaphragm air pump in the LI-8150 is designed for long life; if the pump should fail, however, it can be easily replaced by the user as a complete unit. Complete field installation instructions are included with the replacement pump.

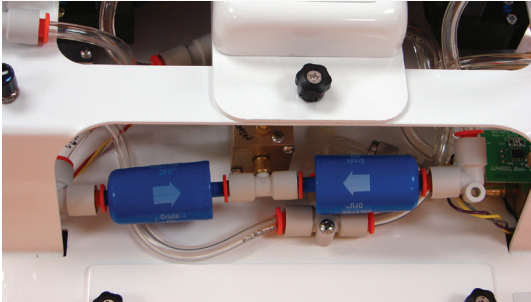

Figure 7. Replace the two Balston filters annually. Press in on the orange ring(s) on the quick connect fittings to remove.

Solenoid Valves

Under normal operation the solenoid valves should not need to be replaced. If however, a solenoid fails to open, it can be easily replaced. Note that each solenoid has a manual override that can be used to test the mechanical opening of each solenoid (they are normally closed). If it appears that a solenoid is not opening (no flow), turn the blue screw on the top of the solenoid valve with a small flathead screwdriver a quarter turn in either direction to manually open the solenoid. If the solenoid does not open manually, it should be replaced. Solenoid valves are available from LI-COR under p/n 300-08249 (1 ea.).

Follow these steps to replace a solenoid:

1. Power the LI-8150 off and open the lid.
2. Remove the single screw on the wired valve connector, pinch the top of the connector, and remove.

3. Remove the two screws on the top of the solenoid valve, remove the solenoid, and discard.
4. Make sure the manifold gasket is in place, and install the new solenoid valve.

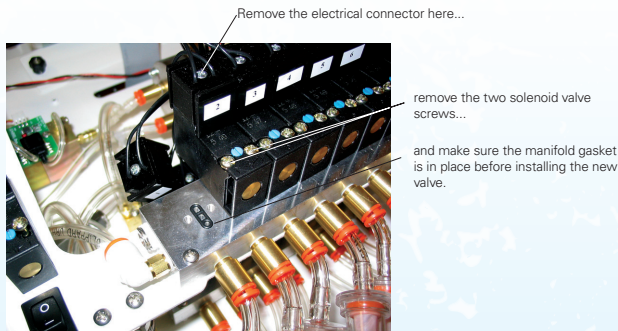

Automatic Restart Function

The LI-8100A has the capability to restart a measurement following a power interruption to the instrument. Enabling this feature requires the user to first reposition a small jumper in the Analyzer Control Unit housing. When the jumper is repositioned, power will be restored to the instrument when it becomes available; note that this function is available only when the LI-8100A is powered via the Auxiliary Sensor Interface, and is not available when powered by a battery inside the Analyzer Control Unit. Note, too, that in order to restart the measurement, this feature

must be also be enabled in software, following the jumper placement.

The LI-8100A jumper is located on the underside of the circuit board located directly below the PC card slots in the Analyzer Control Unit. Remove the access panel to view the jumper. Note that there are three pins aligned horizontally on the underside of the circuit board, below the words "Power On" imprinted on the circuit board. When configured at the factory, the jumper covers the leftmost and center pins (Keypad position, Figure 8). In this position, if power is interrupted, the instrument

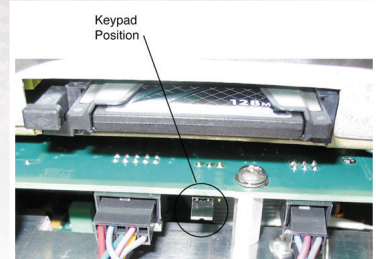

Figure 8. Keypad jumper position.

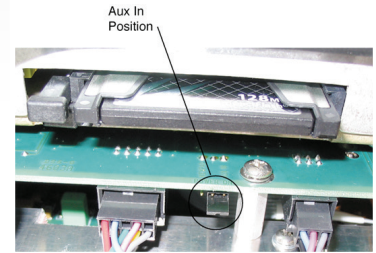

Figure 9. Aux In jumper position

can only be restarted by pressing the On/Off button on the keypad. By repositioning this jumper so that it covers the center and rightmost pins (Aux In position, Figure 9), power can be automatically restored when it becomes available.

IMPORTANT: When the jumper is in the “Aux In” position, the LI-8100A presents a potential shock hazard. For example, if power is interrupted and the unit shuts off, it is possible to remove the access panel and make contact with electrical components; if the user is unaware that a power interruption caused the instrument to shut down, power could be automatically restored while the user is in

contact with these internal components. For this reason, we recommend that you always disconnect the power supply from the instrument before servicing any internal components in the Analyzer Control Unit.

If you want the LI-8100A to restart the current measurement following a power interruption, reposition the jumper to the “Aux In” position as described above, and enable the Auto Restart function in software;

in the LI-8100A Windows software, choose Instrument Settings from the 8100 menu and enable the ‘Resume measurement on instrument restart’ check box, as shown in Figure 10 below. In the LI-8100A HP iPAQ Interface Software, tap on Instrument Settings on the 8100 menu, and enable ‘Automatic Restart’.

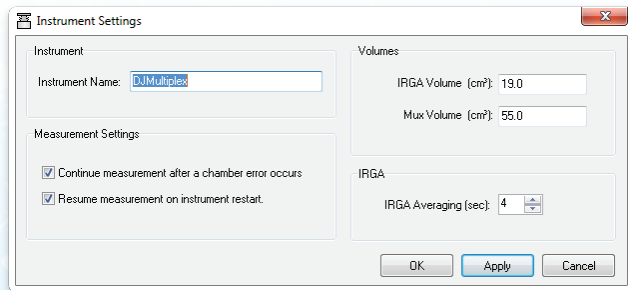

Figure 10. Auto Restart function in Windows® software.

LI-8100A System Power Requirements

Analyzer Control Unit

Power Requirements

Auxiliary Input Voltage: 10.5-28 VDC

Battery Input Voltage: 10.5-15 VDC

3A @ 12V (36W) maximum during warm-up with heaters on

1A @ 12V (12W) average after warm-up with heaters on

LI-8150 Multiplexer

Power Requirements: 10.5 – 14.5 VDC (120 VAC and 240 VAC with optional power supply)

Power supplied through the LI-8150; LI-8150 powers the LI-8100 when connected

See chart for total system power requirements

| LI-8100A + LI-8150 + n Chambers | Sampling: No Chamber Movement | | Sampling: Two chambers move at the same time | | Warming-up: Up to four chambers move at one time | |
|------------------------------------|----------------------------------|-------------------|---|-------------------|---|-------------------|
| | n Chambers | Amps @ 12.5VDC | Watts | Amps @ 12.5VDC | Watts | Amps @ 12.5VDC |
| 1 | 1.0 | 12.5 | 3.0 | 37.5 | 3.0 | 37.5 |
| 2 | 2.0 | 25.0 | 3.8 | 47.5 | 3.8 | 47.5 |
| 4 | 2.1 | 26.3 | 3.8 | 47.5 | 4.8 | 60.0 |
| 8 | 2.1 | 26.3 | 3.8 | 47.5 | 4.8 | 60.0 |
| 16 | 2.3 | 28.8 | 3.8 | 47.5 | 4.8 | 60.0 |

Wireless Troubleshooting

If you cannot establish a wireless connection, check the following:

1. Are you using a PDA that has wireless capabilities?
2. Did you enter the Network Name correctly (e.g. "Soil Network 1") in the LI-8100A and the PDA?
3. Verify instrument IP address is correct using the proper serial connection.
4. Verify PDA IP address is not the same as the instrument IP address Prefs > Wi-Fi > Details > Edit Network > Advanced
5. Verify the network type is peer-to-peer (ad-hoc), not access point.
6. Make sure the subnet mask is 255.255.255.0 on the instrument and PDA.
7. Power the instrument off, make sure the wireless card is seated properly, and turn the instrument back on.
8. Shorten the distance between the LI-8100A and the PDA (<3m).

LI-8100A System Part Numbers

LI-8100A Analyzer Control Unit

| | |
|----------|---|
| 6400-03 | Rechargeable Battery |
| LI-6020 | Battery Charger |
| 8100-201 | Soil Temperature Probe (Omega) |
| 8100-202 | Soil Moisture Probe (Decagon) |
| 8100-203 | Soil Temperature Thermistor |
| 8100-204 | Theta Moisture Probe (Delta-T) |
| 8100-405 | CO ₂ Mapping Kit |
| 8100-510 | DVD Training Set |
| 8100-554 | Compact Flash Memory Card |
| 8100-604 | Leveling Stake |
| 8100-704 | Cable/Hose Assembly (Single Chamber 8100-104 Cable) |
| 8100-664 | Trace Gas Sampling Kit |
| 6581-044 | Soil Collar (20 cm) |
| 6581-157 | Soil Collar (10 cm) |

LI-8150 Multiplexer

| | |
|-------------|--|
| 8150-706 | DC Power Cable |
| 8150-770 | AC Power Supply |
| 8150-661 | Chamber Sensor Interface (8100-101 only) |
| 8150-705 | Cable/Hose Extension Assembly |
| 8150-202 | Soil Moisture Probe (Decagon) |
| 8150-203 | Soil Temperature Thermistor |
| 8150-204 | Theta Moisture Probe (Delta-T) |
| 392-08557 | Sensor Connection Cable |
| 8150-662 | Profiling Kit (4 ports) |
| 8150-916 | 8 to 16 Port Upgrade (Factory) |
| 8150-916-1 | 8 to 16 Port Field Upgrade Kit |
| 8150-670-8 | Flask Sampling Kit |
| 8150-670-16 | Flask Sampling Kit |

Chambers

| | |
|-----------|-------------------------|
| 8100-101 | Long-term Chamber |
| 8100-102 | Survey Chamber (10cm) |
| 8100-103 | Survey Chamber (20cm) |
| 8100-104 | Long-term Chamber |
| 8100-104C | Clear Long-term Chamber |

Spare Parts Kits

| Description | Qty. | LI-COR Part No. |
|---|-------------|------------------------|
| <u>Analyzer Control Unit Spares Kit</u> | 1 | 9981-032 |
| O-rings | 20 | 192-02597 |
| Bev-a-line Tubing | 10' | 222-01824 |
| Balston Disposable Air Filters | 2 | 300-01961 |
| Quick Connect Straight Union | 1 | 300-03123 |
| Quick Connect Right Angle | 2 | 300-03125 |
| Quick Connect Plug | 2 | 300-07124 |
| Quick Connect Coupling | 1 | 300-07125 |
| Quick Connect Union "Y" | 2 | 300-03367 |
| Quick Connect Port Plug | 1 | 9981-118 |
| 3 Amp Fuse | 1 | 439-04215 |
| Auxiliary Sensor Interface Spares Kit | 1 | 9981-028 |
| Strain Relief | 5 | 198-07221 |
| EPDM Plugs | 10 | 610-08324 |
| Santoprene | 1' | 222-08325 |
| 3 Amp Fuse | 1 | 439-04215 |
| Optical Bench Cleaning Kit | 1 | 9981-029 |
| O-rings | 4 | 192-00226 |
| Bev-a-line Tubing | 1' | 222-01824 |
| Wrapped Point Cleaning Swabs | 5 | 610-05314 |
| Sock Tip Swab | 5 | 610-05315 |

| Description | Qty. | LI-COR Part No. |
|--|-------------|------------------------|
| <u>10 cm Survey Chamber Spares Kit</u> | 1 | 8100-621 |
| Cable Ties | 10 | 218-08499 |
| Bev-a-line Tubing | 11' | 222-01824 |
| Thumb Nut | 4 | 165-00140 |
| 10 cm Soil Collars | 6 | 6581-157 |
| 20 cm Survey Chamber Spares Kit | 1 | 8100-631 |
| Cable Ties | 10 | 218-08499 |
| Bev-a-line Tubing | 11' | 222-01824 |
| Thumb Nut | 4 | 165-00140 |
| 20 cm Soil Collars | 6 | 6581-044 |
| Long-Term Chamber Spares Kit | 1 | 8100-611 |
| Cable Ties | 10 | 218-08499 |
| Bev-a-line Tubing | 18' | 222-01824 |
| Thumb Nut | 4 | 165-00140 |
| 20 cm Soil Collars | 6 | 6581-044 |
| 10-32 x 3/4" screws | 6 | 122-07715 |

| Description | Qty. | LI-COR Part No. |
|--|-------------|------------------------|
| <u>10 cm Survey Chamber Gasket Kit</u> | 1 | 8100-622 |
| Foam Seal Gaskets | 20 | 6560-229 |
| Survey Collar Gaskets | 2 | 6581-065 |
| Chamber Flange Gaskets | 2 | 6581-066 |
| Manifold Gaskets | 2 | 6581-057 |
| Seal Washer | 4 | 167-07255 |
| Chamber Gasket Trim | 2.2' | 226-07390 |
| Loctite Adhesive | 1 | 208-05786 |
| 10-32 x 1/2" screws | 4 | 122-00014 |
| 4-40 x 3/8" screws | 18 | 122-01578 |
| 8-32 x 1/2" screws | 4 | 122-04328 |
| <u>20 cm Survey Chamber Gasket Kit</u> | 1 | 8100-632 |
| Cap Nuts | 4 | 163-02618 |
| Foam Seal Gaskets | 20 | 6581-107 |
| Manifold Gaskets | 2 | 6581-057 |
| Soil Collar Gaskets | 4 | 6581-108 |
| Chamber Gasket Trim | 6' | 224-07606 |
| Loctite Adhesive | 1 | 208-05786 |
| 10-32 x 1/2" screws | 4 | 122-00014 |
| 4-40 x 3/4" screws | 2 | 158-07847 |
| Flat washer, #10 | 4 | 167-00154 |
| Seal washer, #10 | 4 | 167-07255 |
| Long-Term Chamber Gasket Kit | 1 | 8100-612 |
| Loctite Adhesive | 1 | 208-05786 |

| Description | Qty. | LI-COR Part No. |
|--|-------------|------------------------|
| Collar Gasket | 2 | 6581-060 |
| Chamber Gasket Trim | 6' | 224-07606 |
| 6-32 x 3/8" screws | 4 | 122-00009 |
| 4-40 x 3/8" screws | 18 | 122-01578 |
| <u>LI-8100A Bellows Kit (optional)</u> | 1 | 8100-623 |
| Silicone Lubricant | 1 | 210-01958-1 |
| 10-32 x 1/2" screws w/o-ring | 4 | 138-07470 |
| Manifold Gasket | 1 | 6581-057 |
| Bellows, 3" I.D. x 4.25" O.D. | 1 | 254-7219 |
| <u>LI-8150 Multiplexer Spares Kit</u> | 1 | 9981-130 |
| Urethane Tubing, 1/8" ID x 1/4" OD | 3' | 222-00303 |
| Hose Barb T-Fitting | 2 | 300-02627 |
| 1/4" Quick Connect Plug | 2 | 300-08151 |
| 3 Amp Fuse | 1 | 439-04215 |
| 5 Amp Fuse | 1 | 439-04214 |
| Jumper Tube Assembly | 1 | 9981-142 |
| Filter Replacement Kit (set of 8) | 1 or 2* | 8150-909 |

* Two kits are included with the LI-8150-16 Multiplexer configuration

LI-8100/A and LI-8150 Measurement Checklist

Single Chamber Measurements

Once the LI-8100/A is turned on and you are able to connect to it using a PC or PDA check the following:

Air flow/Pump – While the pump is turned on disconnect the air in and out hoses and put your fingers on the Air In and Air Out ports of the LI-8100/A and make sure that you can feel the flow of air in and out of the system. Also, make sure that the flow of air is as you would expect it (i.e., into the analyzer through Air In and out from the analyzer through Air out ports). See the LI-8100A/LI-8150 Instruction Manual **Chapter 8 page 30** and **Chapter 9 page 25** for instructions on turning flow on and off.

Pressure – Make sure that the pressure readings reported are reasonable values for your location. See **Chapter 8 page 3** and **Chapter 9 page 19** for instructions on displaying the pressure readings.

Auxiliary sensors – Make sure that all auxiliary sensors are properly connected and the readings from each one are reasonable or appropriate for

your site. See **Chapter 2 pages 9-18**, **Chapter 8 page 11**, or **Chapter 9 pages 29 and 30** for instructions on setting up the auxiliary sensors.

CO₂ and H₂O Zero – Flow CO₂-free dry air through the system to check the zero readings. If there are no offsets both for CO₂ and H₂O, your instrument is performing well. If there is a small offset (a few ppm e.g. ± 10 for CO₂ or a few mmol/mol e.g. ± 2 for H₂O) set the zero of the instrument and recheck the readings to ensure the offsets are at acceptable levels. If the offset is excessive ($> \pm 40$ ppm for CO₂ and $> \pm 5$ mmol/mol for H₂O) this may indicate an incorrect previous zero calibration or the presence of dirt or water in the optical path. Consult with any other users of the LI-8100/A regarding the last zero calibration. Also, check the factory and manual calibration coefficients. See **Chapter 9 pages 25 and 26** and **Chapter 8 page 31** for instructions on how to access the coefficients. The optical path is user cleanable, however the analyzer zero and span must be set for both CO₂ and H₂O after the optical bench is reassembled.

See Chapter 5 for detailed instructions on setting the zero for CO₂ and H₂O. Refer to **Chapter 12** for instructions on cleaning the optical bench.

CO₂ and H₂O Span – Flow a known concentration of CO₂ mixed in dry air through the system to check the CO₂ span reading. Use a dew point generator such as the LI-COR LI-610 Portable Dew Point Generator to generate an air stream with a known dew point to check the H₂O span reading. If the offsets are within the specification of the instrument ($< \pm 1.5\%$ for both CO₂ and H₂O), your instrument is performing well. If there is a small offset above the specification ($< \pm 10\%$ both for CO₂ and H₂O) set the span of the instrument and recheck the readings to ensure the offsets are at acceptable levels. If the offset is excessive greater than ($> \pm 10\%$ both for CO₂ and H₂O) this may indicate an incorrect previous span calibration or the presence of dirt or water in the optical path. Consult with any other users of the LI-8100/A regarding the last span calibration. Also, check the factory and manual calibration coefficients.

See **Chapter 9 pages 25 and 26** and **Chapter 8 page 31** for instructions on how to access the coefficients. The optical path is user cleanable, however the analyzer zero and span must be set for both CO₂ and H₂O after the optical bench is reassembled. See **Chapter 5** for detailed instructions on setting the zero for CO₂ and H₂O. Refer to **Chapter 12** for instructions on how to clean the optical bench.

Thermistor (Chamber Temp) – Make sure that the temperature readings reported as Chamber Temp (°C) are reasonable. See **Chapter 8 page 3** and **Chapter 9 page 19** for instructions on displaying the Temperature readings.

Chamber movement/bellows – Make sure that the bellows pump is running (for survey chambers only) and the chamber movements are smooth. See **Chapter 8 page 29** and **Chapter 9 page 25** for instructions on turning the bellows pump on and off. Use the manual controls dialog to open and close chambers; for the long term chambers use the open/close button to check chamber movement.

Gaskets – Check the gaskets on chambers to make sure that they are not damaged.

Cables and Hoses – Check the hoses and cables to make sure no breaks, kinks or signs of animal/rodent damage are present.

LI-8100/A Filters – There are two Balston Filters inside the LI-8100/A that should be replaced yearly if the instrument is being used fairly regularly. It is a good idea to put the date of replacement on the filters as a reminder when scheduling filter replacements. See **Chapter 12 page 7** for instructions on replacing the air filter inside the LI-8100/A.

Multiplexed Measurements

LI-8100/A – Same as for single chamber measurements.

LI-8150 Multiplexer Flow – When the LI-8150 is attached, Auxiliary Input V1 is dedicated to multiplexer flow (Mux Flow). This reading should stay near 3V for a well functioning multiplexer. See **Chapter 10 page 60** for instructions on turning the multiplexer flow on and off.

External Connectors – Check the connectors on the multiplexer to make sure that they are not corroded or compromised. Put the metal covers

and plastic caps on connectors and fittings that will not be used.

Internal Quick Connectors – Check the internal quick connectors inside the multiplexer by tugging on each to ensure it is properly sealed. Do this especially after changing filters.

Thermistor – Make sure that the temperature readings reported as Chamber Temp (°C) when a chamber is active are reasonable. When the chamber is not active the temperature reported is the LI-8150's case temperature. See **Chapter 8 page 3** and **Chapter 9 page 19** for instructions on displaying the Temperature readings. Refer to **Chapter 12 pages 40-42** for instructions on replacing the chamber thermistor for either long term chamber, the 8100-104 or 8100-104C.

Chamber movement – Make sure that chamber movements are smooth by opening and closing the chamber using the Manual Control dialog in the software or the Open/Close button on the side of the chamber. See **Chapter 10 page 30** for additional information.

Auxiliary sensors – Make sure that all auxiliary

sensors are properly connected and the readings from each one are reasonable or appropriate for your site. See **Chapter 7 page 4** for further instructions.

Gaskets – Check the gaskets on chambers to make sure that they are not damaged. See **Chapter 12** for detailed instructions on replacing gaskets.

Cables and Hoses – Check the hoses and cables to make sure no breaks, kinks or signs of animal/rodent damage are present.

LI-8150 Filters – There are two Balston Filters inside the LI-8150 and up to 16 translucent filters on air input ports that should be checked and possibly replaced yearly if the instrument is being used on a fairly regular basis. Check also the tubing around the filters and replace if

necessary. It is a good idea to put the date of replacement on the filters to assist in scheduling filter replacements. See **Chapter 10 page 115** for further details.

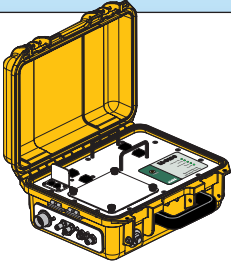
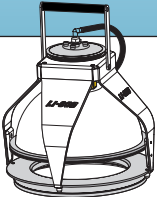
| Single Chamber Measurements | Item | Frequency |
|---|---|------------|
| LI-8100/A | | |
|  | Air Flow/Pump | Daily |
| | Pressure | Daily |
| | Auxiliary Sensors | Daily |
| | CO ₂ and H ₂ O Zero | Seasonally |
| | CO ₂ and H ₂ O Span | Seasonally |
| | Filters | Seasonally |
| Chambers | | |
|  | Thermistor | Daily |
| | Chamber Movement/Bellows | Daily |
| | Gaskets | Seasonally |
| | Cables and Hoses | Daily |

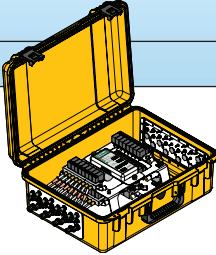
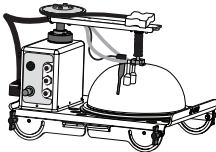
| Multiplexed Measurements | Item | Frequency |
|---|---|------------|
|  | LI-8100/A | |
| | LI-8150 | |
| | Air Flow/Pump | Daily |
| | Pressure | Daily |
| | Auxiliary Sensors | Daily |
| | CO ₂ and H ₂ O Zero | Seasonally |
| Chambers | | |
|  | Thermistor | Daily |
| | Chamber Movement/Bellows | Daily |
| | Gaskets | Seasonally |
| | Cables and Hoses | Daily |



4647 Superior Street • Lincoln, Nebraska 68504
TEL: +1-402-467-3576 • FAX: +1-402-467-2819
envsales@licor.com • envsupport@licor.com • www.licor.com/env

LI-COR GmbH, Germany • +49 (0) 6172 17 17 771
envsales-gmbh@licor.com • envsupport-gmbh@licor.com
*Serving Andorra, Albania, Belarus, Cyprus, Estonia, Germany, Iceland,
Latvia, Lithuania, Liechtenstein, Malta, Moldova, Monaco, San Marino,
Ukraine and Vatican City.*

LI-COR Ltd., UK • +44 (0) 1223 422102
envsales-UK@licor.com • envsupport-UK@licor.com
Serving UK, Ireland, and Scandinavia.

LI-COR Distributor Network: www.licor.com/env/distributors

010/2012 984-11441, Rev. 2

The LI-COR board of directors would like to take this opportunity to return thanks to God for His merciful providence in allowing LI-COR to develop and commercialize products, through the collective effort of dedicated employees, that enable the examination of the wonders of His works.

“Trust in the LORD with all your heart and do not lean on your own understanding. In all your ways acknowledge Him, and He will make your paths straight.”

— Proverbs 3:5,6

© 2012, LI-COR Inc. LI-COR is a registered trademark of LI-COR, Inc in the U.S. and other countries. All other trademarks or registered trademarks are the property of their respective owners. Printed in the U.S.A.