



LogBox-BLE



INSTRUCTION MANUAL V1.0x



1.	SAFETY ALERTS.....	3
2.	INTRODUCTION.....	4
3.	DISPLAY AND NAVIGATION.....	5
3.1	DISPLAY INFORMATION.....	5
3.2	OPERATION KEYS.....	6
3.3	NAVIGATION KEYS.....	6
4.	TECHNICAL SPECIFICATIONS.....	10
4.1	SENSORS RANGE AND ACCURACY.....	11
5.	OPERATION AUTONOMY.....	13
6.	INPUT SIGNALS READING.....	14
6.1	ANALOG INPUTS.....	14
6.1.1	MEASUREMENT AND INDICATION OF INPUT TYPES.....	15
6.2	DIGITAL INPUT.....	17
6.2.1	PULSE COUNT.....	17
6.2.2	EVENT LOG.....	18
6.2.3	LOG CONTROL.....	18
7.	DATA LOGGING.....	19
8.	DIGITAL OUTPUT.....	20
9.	ALARMS.....	21
10.	CONFIGURATION SOFTWARE.....	22
10.1	NXPERIENCE.....	22
10.2	LOGCHART-BLE.....	22
10.3	CONFIGURING WITH NXPERIENCE / LOGCHART-BLE.....	22
10.3.1	GENERAL PARAMETERS.....	22
10.3.2	ANALOG CHANNELS PARAMETERS.....	23
10.3.3	DIGITAL CHANNEL PARAMETERS.....	24
10.3.4	CHANNELS' GENERAL PARAMETERS.....	26
10.3.5	DATA LOGGING CONFIGURATION.....	26
10.4	DIAGNOSTICS.....	28
10.4.1	LOGS.....	28
10.4.2	CHANNELS.....	29
10.4.3	MISCELLANEOUS.....	29
10.5	LOGCHART-BLE SPECIFIC FEATURES.....	29
10.5.1	INSTALLING THE APPLICATION.....	29
10.5.2	APPLICATION OPERATION.....	29
10.5.3	STATUS SCREEN.....	32
10.5.4	CONFIGURATION SCREEN.....	33
10.5.5	LOG SCREEN.....	33
10.6	PREFERENCES SCREEN.....	39
10.7	DATA DOWNLOADS.....	40
11.	INSTALLATION.....	43
11.1	MECHANICAL INSTALLATION.....	43
11.1.1	DIMENSIONS.....	44
11.2	ELECTRICAL INSTALLATION.....	45
11.2.1	INSTALLATION RECOMMENDATIONS.....	45
11.2.2	SPECIAL CARE.....	45
11.2.3	ELECTRICAL CONNECTIONS.....	45
12.	COMMUNICATION INTERFACES.....	48
12.1	USB.....	48
12.2	BLUETOOTH.....	48
13.	TROUBLESHOOTING.....	50
14.	WARRANTY.....	51

1. SAFETY ALERTS

The symbols below are used throughout this manual to draw the user's attention to important information regarding safety and use of the equipment.

		
CAUTION Read the manual thoroughly before installing and operating the equipment.	CAUTION OR DANGER Risk of electric shock	ATTENTION Material sensitive to static charge. Be sure to take precautions before handling.

All safety recommendations in this manual must be observed to ensure personal safety and to prevent damage to the instrument or system. If the instrument is used in a manner other than that specified in this manual, the equipment safety protections may not be effective.

2. INTRODUCTION

LogBox-BLE is a wireless data logger for three analog sensors and one digital sensor, known as analog and digital measurement channels. In addition, it can operate on batteries for long periods, with a memory capacity for up to 140,000 logs, having a large display for visualization of measured variables and general device information. The equipment enclosure has a protection cover for the connections, a locking ring and a mounting bracket that can be mounted on a wall or on a metal surface, by means of the optional holder with magnetic inserts.

The analog inputs accept any type of temperature sensor, such as thermocouples, Pt100 or sensors for any other quantities with current or voltage signals. The digital channel can log the time of events, such as opening a door, or counting pulses from a flow sensor. **LogBox-BLE** also has internal sensors: temperature, battery voltage, and external source voltage, which can also record the values in the memory, taking the place of any of the available measurement channels. Its wide display allows you to view up to 3 variables simultaneously, and displays indications such as alarms, communication status, enabled channels, battery voltage level, and much more. **LogBox-BLE** also has a buzzer for audible alerts and a digital output that can be used as an alarm output or as an electronic key to power sensors.

LogBox-BLE, during operation, logs the data in the memory, with the interval between logs being configurable. All equipment configurations can be accessed by user via desktop or notebook connected to **LogBox-BLE** USB interface or through an *Android smartphone* via *Bluetooth*. For use with computers, NOVUS provides the **NXperience** software in the download area. For users of smartphones running *Android*, NOVUS makes the **LogChart-BLE** application available on *Google Play Store*. Both software tools allow log configuration, data download, and analysis. Also, it is possible to publish these logs on **NOVUS Cloud** for remote view.

3. DISPLAY AND NAVIGATION

3.1 DISPLAY INFORMATION

LogBox-BLE has an LCD display with 3 numerical lines of 4 ½ digits to display the current value of all enabled channels, as well as the minimum and maximum values thereof. At the same time, it is possible to display the current value of up to 3 analog channels and, in a second screen, if enabled, it is possible to display the digital input current value. In addition to channel information, **LogBox-BLE** has 7 screens with a variety of information and features, with 24 symbols that allow for easy information visualization and diagnostics.

Below is an illustration of the display with a descriptive of functionality for each symbol present in it.

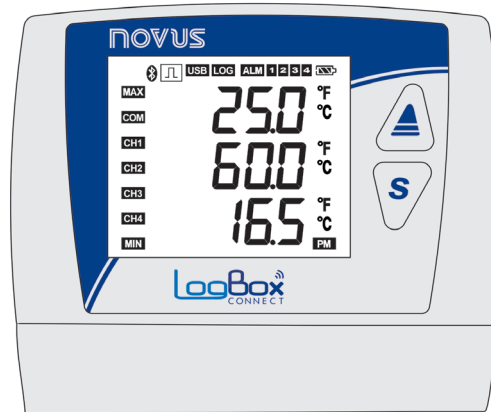

Fig. 01 – LogBox-BLE Display Information

- : Stays on while the *Bluetooth* interface is available for connection or any *smartphone* is connected. If configured to wake up by keyboard, it only remains on while the interface is available.
- : When the digital channel is disabled, it remains off. When set to Counter, it remains lit. When configured as Event Log or Log Control remains lit, flashing only when an event is detected at the digital input.
- **USB**: Lights up when the USB cable is connected, turns off when the USB cable is disconnected.
- **LOG**: It remains lit from the moment it does the first log until the moment it stops logging. In the cases of “daily” registration, where the logging starts and ends every day at a certain time, it will only remain lit within the configured time. Flashes at the time of a log (turns off at the time of a log and restarts).
- **ALM**: Lights up and stays on when you enter an alarm condition, only going out when a new setting is received, or the alarm status is being cleared. It indicates to the user that there was an alarm at some point.
- **1, 2, 3, 4**: Light up while the alarm conditions of the corresponding channels are satisfied: 1 (analog channel 1), 2 (analog channel 2), 3 (analog channel 3) e 4 (digital channel). When you exit the alarm condition, the flag is cleared.
- : Indicates the battery voltage level. This symbol is updated along with the logs interval (even if the equipment is not logging). However, it is done a minimum range of 5 minutes. Thus, if the equipment is configured to log every 1 second, the battery indicator will only refresh every 5 minutes. If the logging interval is longer than 5 minutes, the battery indicator will update with the same logging interval.
 - : Battery over 75%
 - : Battery over 50%
 - : Battery over 25%
 - : Battery below 25% - provide battery replacement.
- **MAX**: Lights up while the “maximum” information is being displayed.
- **COM**: Flashes to inform you that a valid data packet has been received from one of the available communication interfaces.
- **CH1, CH2, CH3, CH4**: Indicates which channels are enabled.
- **MIN**: Lights up while the “minimum” information is being displayed.
- **°F, °C**: If the channel unit is set to °F or °C, one of the symbols is lit during channel display. Otherwise, no unit symbol is displayed.
- **PM**: If the clock is set to display in the 12-hour format, the PM symbol lights up when the clock is displayed, and the time is later than 1 pm.

3.2 OPERATION KEYS



To navigate between the screens, **LogBox-BLE** has two keys:  . Each key, depending on the current navigation screen, has two or more features:

- Short touch (less than 2 seconds):
 - Proceeds to the next screen if the current screen mnemonic is being displayed.
 - Displays the mnemonic of the current screen again if the screen information is displayed.
- Long touch (longer than 2 seconds or held down):
 - Takes any action within the current screen.
- Both keys held down (longer than 2 seconds or held down):
 - Takes a second action within the current screen.











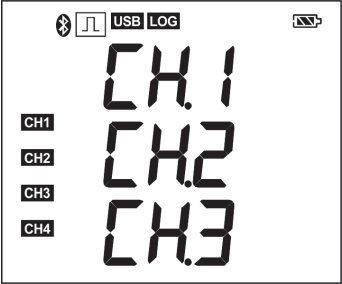
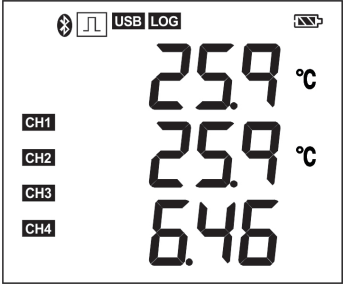

If the *Bluetooth* interface is enabled, any key that is pressed will make the interface visible with a high frequency for an instant of time. For more information, refer to chapter CONFIGURATION SOFTWARE.

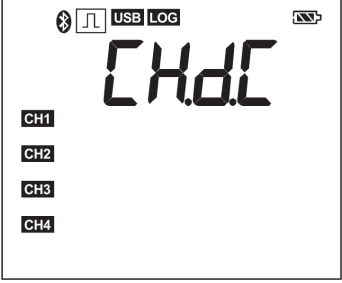
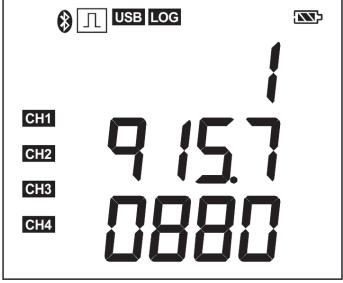



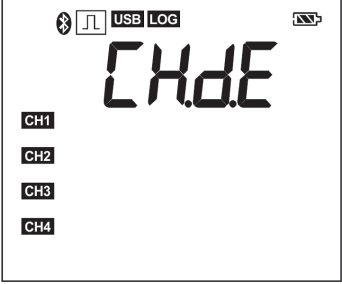
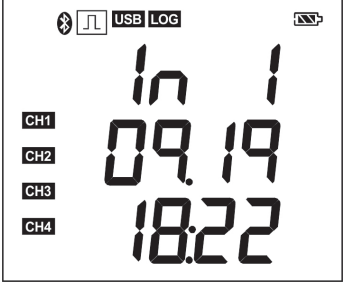





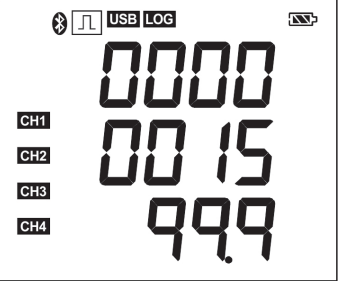

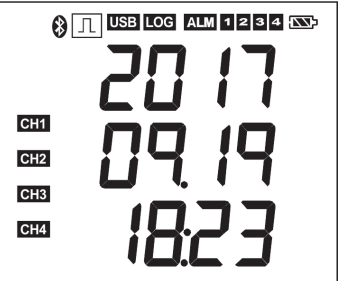

If the buzzer is active, any key pressed will mute it.

3.3 NAVIGATION KEYS

When navigating between screens, a mnemonic is always displayed to streamline the identification of the information contained in each screen. This is displayed each time a key is pressed and is visible for 2 seconds. If no key is pressed for this period, the information on the current screen is displayed. If the  key or the  key is pressed while a mnemonic is displayed, the equipment advances to the next or previous screen, displaying this screen's mnemonic. When the equipment is displaying the information on a screen, simply press any key to make the mnemonic appear again. To enter the screen, just wait 2 seconds.

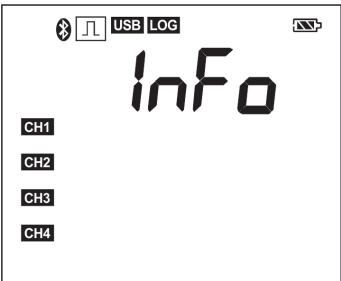
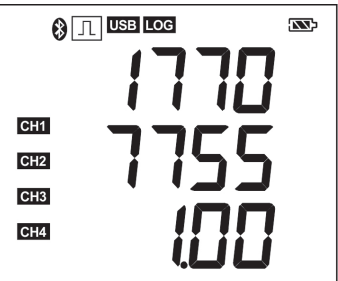
The table below illustrates all the screens available on the equipment, their mnemonics, their information, info description and key function in each of them.

SCREEN	MNEMONIC	INFORMATION	DESCRIPTION	KEYS FUNCTION
1. Analog Inputs	 <p>Displayed for 2 seconds before moving to Analog Inputs screen.</p>	 <p>This screen is updated by the log interval and/or by the display update interval.</p>	<p>Displays the current value of the analog channels and allows the display of the maximum and minimum values reached by each channel.</p> <p>Line 1: Analog channel 1 value. Line 2: Analog channel 2 value. Line 3: Analog channel 3 value.</p>	<p> Key held down or long touch: Informs the maximum value reached in each analog channel.</p> <p> Key held down or long touch: Informs the minimum value reached in each analog channel.</p> <p>  Both keys held down: clears the alarm statuses and the minimum and maximum values reached by each analog channel.</p>
2. Digital Input a. Pulse Count	 <p>Displayed for 2 seconds before moving to Digital Input screen – Pulse Count.</p>	 <p>This screen is only updated by the log interval.</p>	<p>When enabled and configured for Pulse Count, it displays the flow recorded in the pulse count of the last record period for the digital channel. If it is not configured, this screen is not shown.</p> <p>Uses the 3 display lines to display the flow in the user unit with the number of configured decimal places.</p>	<p> Key held down or long touch: it informs the maximum flow reached in the pulse count for the digital input.</p> <p> Key held down or long touch: it informs the minimum flow reached in the pulse count for the digital input.</p> <p>  Both keys held down: clears the alarm statuses and the minimum and maximum values reached in the pulse count for the digital input.</p>
2. Digital Input b. Event Log or Log Control	 <p>Displayed for 2 seconds before moving to Digital Input screen – Event Log or Log Control.</p>	 <p>This screen is updated every time an event is detected in the Digital Input.</p>	<p>When enabled and configured for Event Log or Log Control, displays the last event detected on the digital input. If it is not configured, this screen is not shown.</p> <p>Line 1: Edge detected in event: 0 – Falling edge; 1 – Rising edge. Line 2: Month.Day of the event Line 3: Hour:Minute of the event.</p>	<p> Key held down or long touch: No action.</p> <p> Key held down or long touch: No action.</p> <p>  Both keys held down: No action.</p>

SCREEN	MNEMONIC	INFORMATION	DESCRIPTION	KEYS FUNCTION
3. Log Memory	 <p>Displayed for 2 seconds before moving to Log Memory screen.</p>	 <p>This screen is only updated by the log interval.</p>	<p>Displays the number of logs in the memory and free memory percentage.</p> <p>Line 1 and 2: Number of logs recorded in the memory.</p> <p>Line 3: Free memory percentage.</p>	<p> Key held down or long touch: No action.</p> <p> Key held down or long touch: No action.</p> <p>  Both keys held down: No action.</p>
4. Date/Time	 <p>Displayed for 2 seconds before moving to Date/Time screen.</p>	 <p>This screen is updated by the log interval and/or by the display update interval.</p>	<p>Displays the equipment's current date and time.</p> <p>Line 1: Year</p> <p>Line 2: Month.Day</p> <p>Line 3: Time:Minute</p>	<p> Key held down or long touch: No action.</p> <p> Key held down or long touch: No action.</p> <p>  Both keys held down: No action.</p>
5. Information	 <p>Displayed for 2 seconds before moving to Information screen.</p>	 <p>This screen is static and always has the same value for the same equipment.</p>	<p>Displays equipment information.</p> <p>Line 1 and 2: Serial Number</p> <p>Line 3: Firmware Version</p>	<p> Key held down or long touch: No action.</p> <p> Key held down or long touch: No action.</p> <p>  Both keys held down: No action.</p>









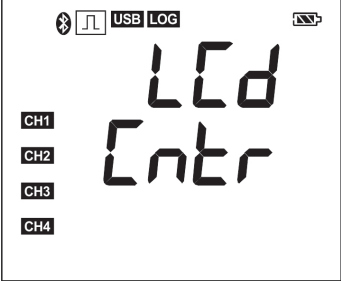

SCREEN	MNEMONIC	INFORMATION	DESCRIPTION	KEYS FUNCTION
<p>6. Display Contrast Adjustment</p>	 <p>Displayed for 2 seconds before moving to Display Contrast Adjustment screen.</p>	 <p>This screen is updated whenever the display contrast is adjusted.</p>	<p>Displays the contrast level configured for the display and allows adjustment of the display.</p> <p>Line 3: Current contrast value. Can be adjusted from 0 to 7.</p>	<p> Key held down or long touch: Increases contrast (maximum of 7).</p> <p> Key held down or long touch: Decreases contrast (minimum of 0).</p> <p>  Both keys held down: No action.</p>
<p>7. Log Status</p>	 <p>Displayed for 2 seconds before moving to Log Status screen.</p>	 <p>This screen is updated whenever the current log status is changed.</p>	<p>Displays the current log status and allows them to be started and/or paused if the equipment is configured to allow keyboard start and/or end.</p> <p>En – Enabled logs; d IS – Disabled logs.</p>	<p> Key held down or long touch: Starts the logs, if start by keyboard is allowed.</p> <p> Key held down or long touch: Pauses the logs, if end by keyboard is allowed.</p> <p>  Both keys held down: No action.</p>

Table 01 – Navigation keys

4. TECHNICAL SPECIFICATIONS

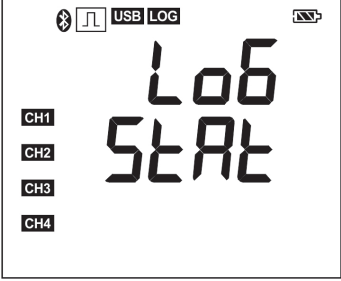
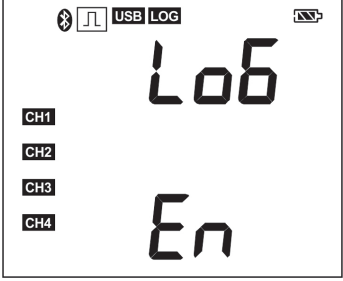
CHARACTERISTICS	LogBox-BLE	
Input Channels	3 analog inputs 1 digital input	
Compatible Analog Signals	Thermocouple J, K, T, N, E, R, S and B, Pt100, 0-50 mV, 0-5 V, 0-10 V, 0-20 mA, 4-20 mA	
Internal Measurements	Internal Temperature (NTC) Battery Voltage External Power Supply Voltage	
Analog Channels Input Impedance	Thermocouples / Pt100 / mV: > 2 MΩ mA: 15 Ω + 1.5 V V: 1 MΩ	
Pt100	Maximum cable offset compensated resistance: 25 Ω Excitation Current: 166 μA Used Curve: $\alpha = 0.00385$	
Digital Input	Logical Levels	Logical Level "0": from 0 to 0.5 Vdc Logical Level "1": from 3 to 30 Vdc
	Maximum Voltage	30 Vdc
	Input Impedance	270 kΩ
	Input Current @ 30 VDC (typical)	150 μA
	Maximum Frequency (square wave)	Dry Contact: 10 Hz PNP: 2 kHz NPN: 2 kHz
	Minimum Pulse Duration	Dry Contact: 50 ms PNP: 250 μs NPN: 250 μs
Digital Output	1 PNP-type output Maximum current that can be switched at the output: 200 mA	
Display	3 lines, 4½ digits	
Resolution	Analog Signals: 15 bits (32768 levels) Digital Signal: 16 bits (65536 levels)	
Memory Capacity	140000 logs (total)	
Log Interval	1 second to 18 hours	
Log Type	Instantaneous or Average	
Log Trigger	Date/Time, Start button, digital input or software command	
Alarms	8 available alarms, two by channel Min. (<i>low</i>) and Max. (<i>high</i>)	
Internal Buzzer	Yes, it can be used for alarms	
Communication Interfaces	USB Bluetooth 4.1 (BLE)	
Software and Application	NXperience (via USB for desktops and notebooks) LogChart-BLE (via Bluetooth for smartphones running Android 4.4 or higher)	
Power Supply	Power Supply	Voltage: 10 Vdc to 30 Vdc Maximum Consumption: 15 mA Typical Consumption: 2 mA
	Batteries	4 "AA" type alkaline batteries (included)
Estimated Battery Life	Typical 2 years – Log Interval of 5 minutes	
Operation Temperature	Using the included batteries: -10 to 50 °C Using Energizer L91 batteries: -20 to 60 °C Using external power supply: -20 to 70 °C *	
Enclosure	ABS+PC	
Protection Index	IP40	
Dimensions	120 x 100 x 40 mm	

Table 02 – Technical specifications

* CAUTION with the batteries operation temperature. Extremely high or low temperatures can cause rupture and leakage, causing damage to the equipment.

4.1 SENSORS RANGE AND ACCURACY

	Sensor	Sensor Minimum Value	Sensor Maximum Value	Sensor Resolution	Accuracy (%)
Thermocouples	J	-100.0 °C -148.0 °F	760.0 °C 1400.0 °F	0.1 °C 0.2 °F	0.15 % (F.S.) ± 0.5 °C
	K	-150.0 °C -238.0 °F	1370.0 °C 2498.0 °F	0.1 °C 0.2 °F	0.15 % (F.S.) ± 0.5 °C
	T	-160.0 °C -256.0 °F	400.0 °C 752.0 °F	0.1 °C 0.2 °F	0.15 % (F.S.) ± 0.5 °C
	N	-270.0 °C -454.0 °F	1300.0 °C 2372.0 °F	0.1 °C 0.2 °F	0.15 % (F.S.) ± 0.5 °C
	E	-90.0 °C -130 °F	720.0 °C 1328.0 °F	0.1 °C 0.2 °F	0.15 % (F.S.) ± 0.5 °C
	R	-50.0 °C -58.0 °F	1760.0 °C 3200.0 °F	0.3 °C 0.5 °F	0.15 % (F.S.) ± 0.5 °C
	S	-50.0 °C -58.0 °F	1760.0 °C 3200.0 °F	0.4 °C 0.7 °F	0.15 % (F.S.) ± 0.5 °C
	B	500.0 °C 932.0 °F	1800.0 °C 3272.0 °F	0.4 °C 0.7 °F	0.15 % (F.S.) ± 0.5 °C
Pt100	Pt100	-200.0 °C -328.0 °F	650.0 °C 1202.0 °F	0.1 °C 0.2 °F	0.15 % (F.S.)
Linear	0 to 50 mV	0.000	50.000	0.003 mV	0.15 % (F.S.)
	0 to 5 V	0.000	5.000	0.6 mV	0.15 % (F.S.)
	0 to 10 V	0.000	10.000	0.6 mV	0.15 % (F.S.)
	0 to 20 mA	0.000	20.000	0.001 mA	0.15 % (F.S.)
	4 to 20 mA	4.000	20.000	0.001 mA	0.15 % (F.S.)
Digital Input	Count Mode	0	65535		0.01 % (F.S.)
Internal Sensors	Temperature (NTC)	-40 °C -40 °F	125.0 °C 257.0 °F	0.1 °C 0.1 °F	0.15 % (F. E.) ± 0.5 °C
	Battery Voltage	3.6	6.5	0.01 V	2 % (F.S.)
	External Power Supply Voltage	10.00	30.00	0.01 V	2 % (F.S.)

* F.S. = Full Scale = Span

Table 03 – Sensors range and accuracy

Accuracy: The sensor accuracy reading is measured in relation to the Full Scale and is proportional to the maximum measuring range of each sensor. For example, for a Pt100 sensor, which the **LogBox-BLE** can read in the range of -200 to 650 °C, with a precision of 0.15 %, the accuracy in °C will be $(650 °C - (-200 °C)) * 0.15 \% = 1.28 °C$.

Internal Temperature Sensor: The **LogBox-BLE** has an internal temperature sensor of the NTC type that can be used for monitoring the ambient temperature. This sensor is used for the Thermocouples Cold Junction compensation. Because this sensor is located inside the housing of the equipment, it may present a greater error than specified when there are sudden variations in ambient temperature. The specified accuracy is only guaranteed when the equipment is installed in an environment with a stable temperature for a time greater than 1 hour. The sensor allows readings in a range of -40 °C to 125 °C; however, the temperature is limited to the equipment's operation range.

Thermocouples: The analog input circuit for the **LogBox-BLE** guarantees the accuracy specified in the Thermocouple sensors reading with a maximum cable impedance of 100 Ω . Thermocouple sensors with impedance above 100 Ω can be read by **LogBox-BLE**, however, accuracy is not guaranteed. For reading the thermocouple sensors, the **LogBox-BLE** uses the internal temperature sensor for Cold Junction compensation. Just as with the internal temperature sensor, thermocouples may present a greater error than specified when there are sudden variations in ambient temperature. The specified accuracy is only guaranteed when the equipment is installed in an environment with a stable temperature for a time greater than 1 hour.

Pt100: The **LogBox-BLE** analog input circuit guarantees the accuracy specified in the reading of Pt100 type sensors with a maximum cable resistance of up to 25 Ω . The equipment can read sensors with cables that have resistance above 25 Ω , but in these cases the accuracy and measurement range are not guaranteed. The **LogBox-BLE** performs the cable resistance compensation internally, if it is the same in the 3 wires that connect the equipment to the sensor.

Linear 0 to 50 mV: The analog input circuit of the **LogBox-BLE** guarantees the specified accuracy when reading electrical quantities of voltage type 0 to 50 mV with a maximum cable impedance of up to 100 Ω . Voltage sources with series impedance above 100 Ω can be read by **LogBox-BLE**, however, accuracy is not guaranteed.

Linear 0 to 5 V and 0 to 10 V: The **LogBox-BLE** analog input circuit guarantees the specified accuracy when reading electrical quantities of voltage type 0 to 5 V and 0 to 10 V with a maximum cable impedance of up to 200 Ω . Voltage sources with series impedance above 200 Ω can be read by **LogBox-BLE**, however, accuracy is not guaranteed.

Linear 0 to 20 mA and 4 to 20 mA: All **LogBox-BLE** input channels have common ground with each other as well as with the power supply. Thus, for the **LogBox-BLE** to be able to correctly measure the current transmitters, it is necessary that they are powered by isolated sources or that they are all used with the interconnected ground.

Digital Input: All **LogBox-BLE** input channels have common ground with each other as well as with the power supply. Therefore, for the **LogBox-BLE** to correctly measure the Digital Input sensor, this characteristic must be considered. For the logic levels of the sensor connected to the digital input to be correctly detected, it is recommended that the maximum series resistance with the sensor is less than 10 k Ω .

5. OPERATION AUTONOMY

The **LogBox-BLE** comes with 4 AA alkaline batteries (1.5 V each) with a working temperature specification of -10 °C to 50 °C. They have a capacity of 2000 mAh, which gives the typical duration of 2 years in the following configuration:

- Log Interval: 5 minutes
- *Bluetooth* Frequency: 1 second

NXperience, when finalizing a configuration, displays a typical battery runtime estimate for the configuration being applied. For a battery life estimate based on the equipment configuration, use it. The autonomy displayed by the configuration software is estimated and does not use information about batteries' current statuses. In addition, several factors may contribute to the failure of the autonomy presented. Therefore, follow the information described in the text below to avoid premature wear of the batteries.

Very high (over 30 °C) or very low (below 10 °C) temperatures cause the battery chemistry to react outside typical operation characteristics, reducing the typical range. Thus, when operating the equipment in these ranges, consider that the 2-year expectation can be reduced considerably.

Very high temperatures (above 30 °C) or very low temperatures (below 10 °C) make the **LogBox-BLE** circuit greatly increase its consumption. Thus, when operating the equipment in these ranges, consider that the 2-year expectation can be reduced considerably.

Some scenarios can greatly increase **LogBox-BLE** consumption, thus, considerably reducing the battery service life expectancy. Here are some examples that may decrease battery life:

- Alarm: Alarm occurrences more than once a day and with a buzzer duration over 30 seconds.
- *Bluetooth*: Configuration management, monitoring, or downloads performed by the *Bluetooth* interface at a frequency higher than once a month.
- Data Download: Downloads made by the *Bluetooth* interface, of the whole memory, with a frequency more than once a month.
- Event Log: Events that occur at a frequency greater than once every hour.

When necessary, the batteries can be replaced with any models that have characteristics similar to alkaline batteries (1.5 V). However, it is recommended to replace them with the same model that accompanies the **LogBox-BLE** (*Energizer E91*) or *Energizer L91* (because it has a higher operation temperature range) in order to guarantee the estimated battery life expectancy and the specified job. If you choose to use another battery model, it is necessary to check the working temperature and the capacity expectation of it.



Never mix batteries of different models, or new batteries with used ones. Whenever you are replacing the batteries, replace all of them at the same time.

Check the batteries polarity before inserting them into the equipment. Never use an inverted battery.

6. INPUT SIGNALS READING

LogBox-BLE allows users to choose, along with channels to be registered and sensor types, some configurations that provides flexibility to various applications, allowing users to consider the energy resources (battery life) and data storage (length of log memory). Thus, it is possible to configure the equipment with the following parameters:

- Log Interval: Frequency, in seconds, with which an acquisition must be made and logged in the memory. Low frequency increases battery consumption and fills memory faster.
 - Minimum Interval:
 - 1 second - if no channel is configured to operate on average;
 - 10 seconds - if a channel is configured to operate on average.
 - Maximum Interval: 18 hours.
- Display Update Interval: Frequency, in seconds, with which an acquisition must be made and updated on the display. It allows you to save memory by configuring it to a larger range of logs with a faster Display update rate. Low interval increases battery consumption. This range can be disabled by configuring it to '0'. Thus, the display update will take place in the log interval.
 - Minimum Interval: 1 second;
 - Maximum Interval: 1 hour.

When configuring a Display Update Interval, it should be less than the Log Interval. Otherwise, it will be ignored, and the display will be updated in the Log Interval.

The Display Update Interval only updates analog channels that are not configured to operate on average. Thus, the Digital Channel that is configured to operate in Pulse Counting mode and the Analog Channels that are configured to operate on average will only have their information updated at each log interval.

If the Digital Channel is operating in the Event Log mode, it updates its respective information on the display to each event.

6.1 ANALOG INPUTS

LogBox-BLE has three channels for reading analog signals. The types of signals and sensors accepted are:

- Temperature Sensors:
 - Thermoresistance Pt100;
 - Thermocouples J, K, T, N, E, R, S and B;
 - Internal Temperature Sensor.
- Linear Sensors:
 - 0 to 50 mV;
 - 0 to 5 V;
 - 0 to 10 V;
 - 0 to 20 mA;
 - 4 to 20 mA.
- Internal Diagnostic Sensors:
 - Battery Voltage;
 - External Power Supply Voltage.

Each of these types of sensors has specific operation configurations and characteristics. Below are described these configurations and characteristics:

- Temperature Sensors:
 - Temperature Sensors inform the measured sensor temperature within the possible measuring range of each sensor.
 - The maximum resolution for the Temperature Sensors is 0.1 °C;
 - You can configure them to be displayed with one or no decimal places;
 - You can configure them to be displayed in units of measure °C or °F.
- Linear Sensors:
 - The Linear Sensors report some magnitude, in the range required by the user (User Range), as configured in the Lower Limit, Upper Limit, and Number of Decimal Places parameters.
 - Number of Decimal Places: you can choose to use 0, 1, or 2 decimal places;
 - Lower Limit: value configured by the user to represent the minimum value of the chosen sensor;
 - Minimum -19999 to 0 decimal places;
 - Minimum -1999.9 to 1 decimal place;
 - Minimum -199.99 to 2 decimal places.
 - Upper Limit: value configured by the user to represent the maximum value of the chosen sensor;
 - Maximum 19999 to 0 decimal places;
 - Maximum 1999.9 to 1 decimal place;
 - Maximum 199.99 to 2 decimal places.
 - You can configure them to be displayed in units of measurement °C, °F or customized (8 characters - will not show on the display);
 - The maximum resolution for Linear Sensors is a ratio between the User Range and the maximum resolution of the chosen sensor.

- Internal Diagnostic Sensors:
 - The Internal Diagnostic Sensors inform the voltage of the possible **LogBox-BLE** power supplies;
 - The maximum resolution for the Internal Diagnostic Sensors is 0.01 V;
 - You can configure them to be displayed with 0, 1, or 2 decimal places;
 - The unit of measure for these sensors is Volts and no unit symbol is displayed.

The accuracy of these types of signals is described in the chapter TECHNICAL SPECIFICATIONS. The connection of these signals is described in chapter INSTALLATION.

An analog/digital (A/D) converter with high resolution and accuracy is used to read the sensors connected to the analog channel inputs. In the desired scan range, all the analog channels enabled will be read.

Each type of input signal has a valid measuring range (detailed in chapter TECHNICAL SPECIFICATIONS) of this manual. However, the equipment typically can measure signals which slightly exceed the limits of this range. How much it can measure beyond the range depends on the type of input configured and might vary between different equipment.

The following table describes what to expect in the **LogBox-BLE** display according to the signal applied to the input for each configured input type.

6.1.1 MEASUREMENT AND INDICATION OF INPUT TYPES

INPUT TYPE	INPUT SIGNAL CONDITION	INDICATION
Pt100	Within range	Read input value
	Pt100 with one or more wires disconnected	---- will be displayed
	Slightly above the upper limit	-22000 will be logged in the memory
	Slightly under the lower limit	Read input value *
	Far above the upper limit	UUUU will be displayed 32767 will be logged in the memory
	Far under the lower limit	NNNN will be displayed -32000 will be logged in the memory
Thermocouples J, K, T, E, N, R, S, and B	Within range	Read input value
	Open Thermocouple	---- will be displayed -22000 will be logged in the memory
	Slightly above the upper limit	Read input value *
	Slightly under the lower limit	Read input value *
	Far above the upper limit	UUUU will be displayed
	Far under the upper limit	NNNN will be displayed -32000 will be logged in the memory
Voltage 0 to 50 mV	Within range	Read input value converted into User Range
	Disconnected signal	---- will be displayed -22000 will be logged in the memory
	Slightly above the upper limit	Read input value converted into User Range *
	Slightly under the lower limit	Read input value converted into User Range *
	Far above the upper limit	UUUU will be displayed 32767 will be logged in the memory
	Far under the lower limit	NNNN will be displayed -32000 will be logged in the memory
Voltage 0 to 5 V 0 to 10 V	Within range	Read input value
	Disconnected signal	0 V value converted into User Range
	Slightly above the upper limit	Read input value converted into User Range *
	Slightly under the lower limit	Read input value converted into User Range *
	Far above the upper limit	UUUU will be displayed 32767 will be logged in the memory
	Far under the lower limit	NNNN will be displayed -32000 will be logged in the memory

INPUT TYPE	INPUT SIGNAL CONDITION	INDICATION
Current 0 to 20 mA	Within range	Read input value converted into User Range
	Disconnected signal	0 mA value converted into User Range
	Slightly above the upper limit	Read input value converted into User Range *
	Slightly under the lower limit	It is not possible to decrease beyond the lower limit
	Far above the upper limit	UUUU will be displayed 32767 will be logged in the memory
	Far under the lower limit	It is not possible to decrease beyond the lower limit
Current 4 to 20 mA	Within range	Read input value converted into User Range
	Disconnected signal	---- will be displayed -22000 will be logged in the memory
	Slightly above the upper limit	-22000 will be logged in the memory
	Slightly under the lower limit	Read input value converted into User Range *
	Far above the upper limit	UUUU will be displayed 32767 will be logged in the memory
	Far under the lower limit	NNNN will be displayed -32000 will be logged in the memory.

(*) **Note:** The analog channel indication continues slightly beyond the limits specified for the selected input type. However, in this condition, accuracy is not guaranteed.

Table 04 – Measurement and indication of input types by **LogBox-BLE**

LogBox-BLE allows you to configure settings to be applied to analog sensor readings. These settings can be used to correct sensor or process errors in which the sensor is installed and can be applied individually for each analog channel. Two adjustment modes are provided by the equipment:

Offset: It allows for each analog channel to choose an offset value to be added to the channel reading indication. It is a simple and fast feature to adjust the display throughout the range.

Custom Calibration: It is a feature that allows you to enter up to 10 set points for each channel in order to correct distortions in reading these channels at these points. We call this characteristic a "custom calibration" because it allows the user to adjust the indication at the desired points by zeroing the error at those points. The adjustment is made linearly between the points entered, according to the values entered.

It is important to note that both the offset adjustment and the insertion of custom calibration points is optional, only available for those who wish to adjust the indication to a local standard, since the **LogBox-BLE** is already fully factory calibrated.

	Whenever you change the input type, make sure that the custom calibration points of the previous input are deleted!
---	--

For each analog channel, a unique tag must be assigned, which will be used to reference the channel. You should also choose the type of input (sensor) that will be connected to that channel. In addition to that, you can assign the unit of measured value: when using temperature sensors (Pt100 or thermocouples) you must choose between Celsius (°C) and Fahrenheit (°F) degrees; when using linear sensors (current or voltage), you can enter the desired unit.

In the case of linear input types, one must choose the sensor indication range, that is, what the channel should indicate when the input is at its minimum value and what it should indicate when it is at its maximum value (minimum and maximum values considering the **LogBox-BLE** working range for the chosen input type). Example: the input type 4 to 20 mA is selected and a pressure transmitter from 0 to 2 bars is connected. In this case, "0.0" must be chosen as the minimum value and "2.0" as the maximum value in the input configuration. All resolution and accuracy available will be contained within the chosen range.

When using any equipment on the analog inputs that are connected to the mains (e.g., thermocouple or voltage simulator), and it is not isolated, it is recommended to use a different reading interface than USB. In some cases, noise and read offsets have already been detected due to the influence of the USB cable connection, probably by ground loops.

The **LogBox-BLE**, when operated by batteries, keeps the entire analog circuit switched off while no acquisition is being made. This strategy is necessary so that it can operate for more than 2 years without needing to change batteries. This characteristic may cause some undesirable effects during calibration, as some analog signal simulators (e.g., thermocouple simulator, Pt100) may not operate properly, causing false reading offsets and oscillations. If such a problem is identified, it is recommended to power the **LogBox-BLE** via external power supply or USB while using the simulator.

It is important to set the local network frequency (50 Hz or 60 Hz) to improve the reading performance of the analog channels, even if the equipment is running on batteries. The power grid typically causes interference in the signal read from the sensors, which can be more easily mitigated if we know the frequency.

6.2 DIGITAL INPUT

LogBox-BLE has a Digital Input channel that can be configured for Pulse Count, Event Log, or even for Log Control. This Digital Input can be disabled.

Regardless of the function for which it will be used, the sensor output type that will be connected to the input must be configured: PNP, NPN, or Dry Contact (refer to chapter INSTALLATION to see how the sensors should be connected). In addition to that, you must select which digital signal edge of interest to generate the count, event or start/end of logs for: rising edge, falling edge, or both edges.

Relationship between Sensor Type, Sensor Status, and Logical Level obtained in LogBox-BLE		
Sensor Type	Sensor State	Logical Level
PNP	Open	0
	Closed	1
NPN	Open	1
	Closed	0
Dry Contact	Open	1
	Closed	0

Table 05 - Digital Input

For Dry Contact sensors, it is necessary to set a *debounce* time of at least 50 ms (sensor stabilization time - time in which the sensor must remain in the state of interest for it to be considered valid). However, for PNP or NPN type sensors, it is not necessary to set a *debounce* time if they are configured for Pulse Count. However, if the digital input is configured for Event Log or Log Control, a minimum *debounce* of 50 ms is required to prevent any noise from generating a false event. In the Event Log and Log Control modes, events will be generated after the end of the *debounce* time.

6.2.1 PULSE COUNT

By setting the Digital Input for Pulse Count, it is possible to count the number of pulses occurring within a period and to log the average flow rate. **LogBox-BLE** has a 16-bit register for accumulating the number of pulses within a given range and logging it in the memory. Thus, at each log interval, **LogBox-BLE** captures the number of pulses within that interval and logs it in the memory, zeroing the register to accumulate the pulses for the next interval.

The **LogBox-BLE** is capable of counting up to 10 pulses per second if the sensor configured is Dry Contact type and 2000 pulses per second for PNP and NPN sensor types. However, it is important to note that these pulses will accumulate within the log interval. Thus, it is necessary to evaluate the sensor maximum frequency so that it does not exceed 65535 counts (16 bits) within the log interval and *overflow* the register that accumulates the counts.

Ex.: If the maximum sensor frequency is 2 kHz, the **LogBox-BLE** will accumulate 2000 pulses per second for up to 32 seconds. Because, by exceeding this interval, the number of accumulated pulses will exceed 65535 counts, resulting in *overflow* in the accumulator register. Thus, for a sensor that can reach 2000 pulses per second, it is recommended that the log frequency be less than 32 seconds.

In typical applications, such as flow and volume measurement, simple pulse counting is not enough, being necessary to convert these pulses into a flow unit. For this, one can select the desired flow unit and a conversion factor that transforms the number of pulses generated by the connected transmitter in flow information. The pulse conversion logged in the interval for the flow unit configured by the user will occur every time the logged data is displayed.

To streamline the configuration of the digital channel in Pulse Count mode and the conversion to flow in the unit required for the user, **LogBox-BLE** provides the following units of measure:

Flow Units	Sensor Units
l/s, l/min, l/h, gal/s, gal/min, gal/h, m ³ /s, m ³ /min, m ³ /h	pulses/l, pulses/gal, pulses/m ³

If you use one of these Flow and Sensor Units, you only need to inform the Sensor Factor. If none of the units available is required, you need to calculate the User Factor, relating it to the User Unit, Sensor Unit, and Sensor Factor, and fill in the parameter so that **LogBox-BLE** can correctly convert the pulses to the unit required. In this case, **LogBox-BLE** will convert the pulses to the user unit as follows:

- User Value = (Count)/(Sensor Factor)*(User Factor)
 - It should be considered that the log interval is 1 second. It will not affect the calculation, because internally the **LogBox-BLE** always considers the log interval.

The screenshot shows a configuration window titled "Digital Input". The fields are as follows:

- Tag: Digital
- Input Mode: Pulse Count
- Sensor Type: PNP
- Countin Edge: Rise
- User Unit: l/min
- No. of Decimal Places: 0
- Sensor Factor: 1
- Lower Alarm: 0
- Upper Alarm: 0
- Hysteresis: 0

Example:

Let's say an application has a PNP-type sensor that computes a produced piece every 30 rising-edge pulses and that the user wants to visualize the production in pieces per minute. **LogBox-BLE** must have its Digital Input configured with the following parameters:

- Log Interval: It must be configured in terms of logging the sensor maximum frequency.
- Input Type: Count
- Sensor Type: PNP
- Counting Edge: Rise
- User Unit: Custom
- Sensor Factor: 30 (pulses/piece)
- User Factor: 60 (conversion of pieces per second to pieces per minute)

Thus, **LogBox-BLE** will log, in each log interval, the number of pulses occurring within that period, and every time the data is displayed, it will turn those pulses into the number of pieces produced per minute (custom unit of the user).

In the same example, let's say that the log interval is 20 seconds. Thus, if the sensor gives 20 pulses per second, the **LogBox-BLE** will register 400 pulses per range, displaying to the user 40 pieces per minute $((20 \text{ pulses/s}) / (30 \text{ pulses/piece})) * 60 (1 \text{ min}) = 40$.

6.2.2 EVENT LOG

If the digital input is configured for Event Log, each selected border will cause a log in the memory, informing the event and the instant the event occurred. This log will not be synchronized with the periodic logs, but will also respect the logs beginning and end mode. Events will be logged after the configured *debounce* time expires. Thus, events will be logged with the *debounce* time delay. **LogBox-BLE** can log up to 10 events within 1 second.

6.2.3 LOG CONTROL

You can use the digital input to start and/or pause the logs of the other input channels. Once configured as Log Control, each border selected will start or stop the process of in-memory logs. As in the Event Log mode, detected events will only act after the configured *debounce* time expires. Thus, the start/pause of the logs will be performed with the *debounce* time delay.

7. DATA LOGGING

Data logging will be done in **LogBox-BLE**'s internal memory. The internal memory capacity is up to 140,000 logs. The number of logs that can be stored in the internal memory depends basically on the number of input channels that are enabled, as well as factors such as recording or not recording the digital input event.

Any channel types (analog, counts, or events) can be recorded in the memory. In the case of analog channel logs or the digital input in pulse counting mode, the logging is periodic and has its interval configured through the configurator software. At the end of each log interval, the current values of the enabled channels are logged in the memory. In case the digital input is configured as event log, the logs detected by it will be performed asynchronously to the frequency of the other channels and will be performed at the moment the event occurs.

There are several ways to start and stop logs, many of which can be combined freely. During logging, all selected channels will be logged in the memory and the range between logs will be respected.

Depending on the type of start and stop selected, there may be log "snippets" in the memory and, therefore, periods with no logged data. This is fully compatible with the equipment and is not a problem at all.

In addition to the start and end modes, you must also configure the memory mode, which can be:

- **Circular Memory:** Logs will be made continuously in the selected memory. When the memory is full, the oldest data will be erased so that the most recent data can be saved.
- **Full Memory:** Logs are terminated when the memory has no more space available.

The available start modes are as follows:

- **Immediate Start:** The logs will start immediately after reconfiguring the equipment.
- **By Date/Time:** The logs will start in the configured date/time.
- **Via Keyboard:** There is a screen in the display where you can change the log status to *enabled*. Therefore, the logs will start at this point if they are not already started.
- **Via Digital Input:** When the Digital Input is triggered, the logs are started. In this case, the Digital Input channel must have been set to Log Control. To control the logs by Digital Input, 4 modes are possible:
 - Starts logs at each rising edge;
 - Initiates logs at each falling edge;
 - Logs at logical level '1' - logs while at logical level '1';
 - In this mode the configured stop mode should be "Logical level pause '0'".
 - Logs at logical level '0' - logs while at logical level '0';
 - In this mode the configured stop mode should be "Logical level pause '1'".
- **Via Software:** Logs are started with a **LogChart-BLE** or **NXperience** command.
- **Daily:** The logs are started every day, at the configured time. A Daily log start mode also requires a Daily log end mode!

The available end modes are as follows:

- **Memory Mode Only:** The configuration chosen for the "memory mode" will dictate the logs behavior: if "full memory" is chosen, the logs will end as soon as there is no more memory space; if "circular memory" is chosen, the logs will continue indefinitely.
- **By Date/Time:** The logs will be finalized at the configured date/time.
- **Via Keyboard:** There is a screen in the display where you can change the log status to *disabled*. Therefore, the logs will be paused at this point if they are not already paused.
- **Via Digital Input:** When the Digital Input is triggered, the logs are ended. In this case, the Digital Input channel must have been set to Log Control. To control the logs by Digital Input, 4 modes are possible:
 - Pauses logs at each rising edge;
 - Pauses logs at each falling edge;
 - Pauses at logical level '0' - pauses while at logical level '0';
 - In this mode the configured start mode should be "Logs in Logical level '1'".
 - Pauses at logical level '1' - pauses while at logical level '1';
 - In this mode the configured start mode should be "Logs in Logical level '0'".
- **Via Software:** Logs are ended with a **LogChart-BLE** or **NXperience** command.
- **Daily:** The logs are paused every day, at the configured time. A Daily log end mode also requires a Daily log start mode!

Number of Channels and Logs Maximum Capacity	
Number of Enabled Channels	Logs Maximum Capacity
1	143,147 logs from 1 channel
2	111,336 logs from 2 channels
3	91,093 logs from 3 channels
4	77,079 logs from 4 channels

Table 06 – Data Logging

8. DIGITAL OUTPUT

The **LogBox-BLE** has a PNP-type Digital Output which when triggered places the voltage from the external source to the Digital Output pin. The **LogBox-BLE** Digital Output can be disabled or configured to operate in one of the modes described below:

- Auxiliary Electronic Switch: Used to control the power supply of external instruments during analog channel readings.
Ex.: 4-20 mA transmitters can be powered by the digital output pin, so that they can only be turned on at the time they are read, thus, saving power from **LogBox-BLE** external power supply, which can be a 12 V battery. In the Auxiliary Electronic Switch mode, it is necessary to set how long before each acquisition the digital output must be triggered.
 - Drive Time: Set, in seconds, in the Auxiliary Electronic Switch mode, how long before each acquisition the Digital Output must be triggered. It is deactivated as soon as the acquisition is complete. This time cannot be longer than the lowest acquisition range (Instantaneous, Average = 1/10 of the instantaneous, Display Interval). If equal to 0, the Auxiliary Electronic Switch will be enabled at the exact moment of an acquisition. If greater than or equal to the lowest acquisition interval, the Auxiliary Electronic Switch will always be enabled.
- Alarm Status: Used to track the current general alarm status. If any channel is in an alarm situation, the Digital Output is triggered. If no channel is set to alarm, the Digital Output is disabled.

9. ALARMS

LogBox-BLE has 4 channels, where in each of them it is possible to set a minimum and a maximum alarm. Alarms are displayed and can be configured to trigger an internal Buzzer for audible warning and a Digital Output for user control.

The alarm configuration general parameters are described below:

- **Buzzer Runtime:** Sets the buzzer runtime for each time the equipment enters an alarm situation. The configuration is performed in seconds from 0 to 65000 s, where 0 means that the buzzer should not be triggered. The longer the buzzer runtime, the greater the battery consumption during the alarm situation.
- **Digital Output Mode:** A digital output can be configured to follow the alarm situation. This way, whenever an alarm situation is satisfied, the Digital Output will be activated. The Digital Output will only be disabled if no channel is in an alarm condition.

When an alarm condition is satisfied, the **ALM** symbol is lit along with the **1**, **2**, **3**, **4** symbols, which correspond to the channels that satisfy the alarm situation in current state. The **1**, **2**, **3**, **4** symbols indicate that the channel is currently in an alarm situation. The **ALM** symbol indicates that since the equipment was powered on or since the last alarm status was cleared, an alarm occurred during that period. The retentive alarm statuses of each channel can be cleared by the user through the display screens or through **NXperience** or **LogChart-BLE**.

For each enabled channel, it is possible to enable a minimum alarm and a maximum alarm. For each alarm, it is possible to configure the following parameters:

- **Setpoint:** Value to be exceeded for the channel to satisfy the alarm situation.
- **Hysteresis:** Barrier to be exceeded for the channel to exit the alarm situation.

After the alarms are enabled, they behave as follows:

- **Maximum Alarm:** The channel enters the Maximum Alarm when the current value is greater than the Maximum Alarm Setpoint and exits the maximum alarm when the current value is less than or equal to the Maximum Alarm setpoint minus the Maximum Alarm hysteresis.
- **Minimum Alarm:** The channel enters the Minimum Alarm when the current value is lower than the Minimum Alarm Setpoint and exits the minimum alarm when the current value is greater than or equal to the Minimum Alarm setpoint plus the Minimum Alarm hysteresis.

The alarm status information, as well as the maximum and minimum values reached in each channel, is updated by any events that trigger an acquisition, which may be a read in the log interval or in the display update interval. If a channel reaches a minimum or maximum value or an alarm condition during an acquisition other than the log interval, it may not be logged in the memory. Thus, statuses may indicate that the channel has already reached one of these situations and the information is not available in a data download.

10. CONFIGURATION SOFTWARE

10.1 NXperience

The **NXperience** software is the main tool for configuring, download and analyzing data for **LogBox-BLE**. It allows you to explore all the features and resources of the register by communicating through its USB interface. It is also a complete data analysis tool logged by **LogBox-BLE**, allowing the joint graphical analysis of multiple data, mathematical calculations, reporting, and export of data in multiple formats. You can download multiple logs and publish the logs in *NOVUS Cloud*, a data portal on the internet from which records can be viewed anytime, from anywhere. **NXperience** is a complete configuration tool for the new NOVUS equipment line. The software generic functionality is described in a specific Operation Manual. Both the manual and the software can be downloaded free of charge at www.novusautomation.com, in the download area.

LogBox-BLE specific configuration features are described in the CONFIGURING WITH NXperience/LogChart-BLE.

10.2 LogChart-BLE

The **LogChart-BLE** application is the ideal tool for the daily use of **LogBox-BLE**. Running on *Android* devices, it is always on hand to monitor, download data, or configure the register. Through the *Android* sharing feature, you can export your registers data by email or store it in *Google Drive*, *Dropbox*, and any other cloud storage tool. Multiple register data can still be published in the *NOVUS Cloud*.

LogChart BLE can be downloaded for free from *Google Play Store*.

LogChart-BLE specific features are described in the CONFIGURING WITH NXperience/LogChart-BLE section.

10.3 CONFIGURING WITH NXperience / LogChart-BLE

LogBox-BLE can be configured via both **NXperience** and **LogChart-BLE**. Below is a description of each possible configuration parameters grouped by sections.

10.3.1 GENERAL PARAMETERS

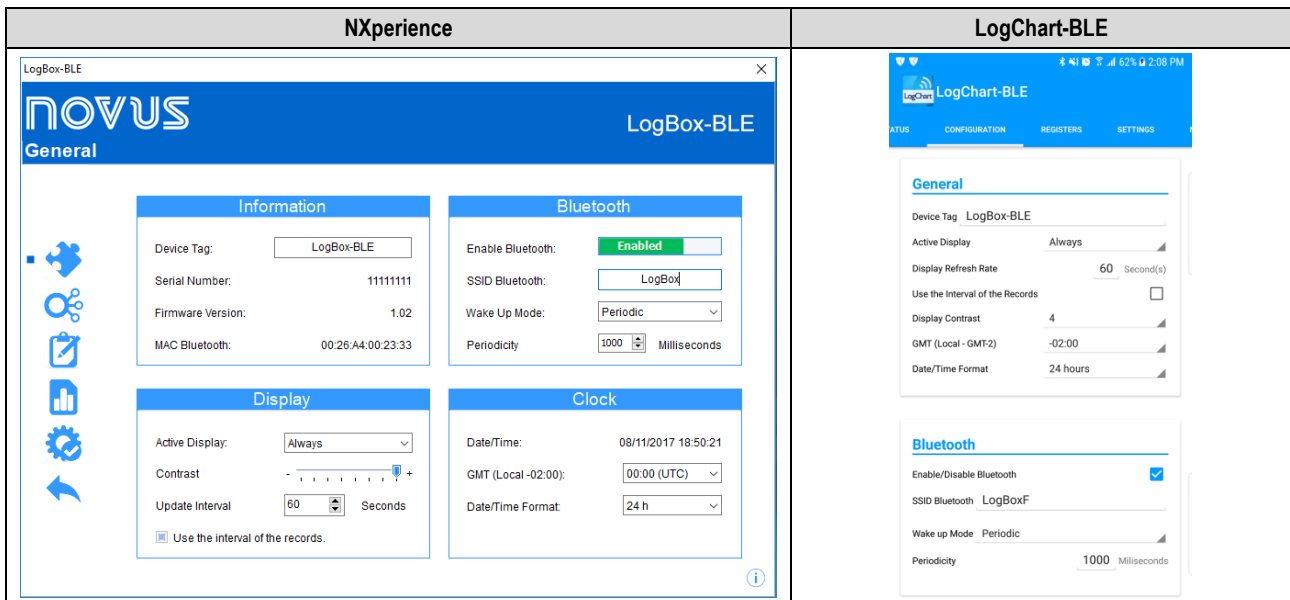

INFORMATION

- **Device Tag:** allows you to configure a name of up to 20 characters for the equipment. This name will be used to identify the equipment in a data download.
- **Serial Number:** informs the equipment unique identification number.
- **Firmware Version:** informs the firmware version that is recorded on the equipment.
- **MAC Bluetooth:** informs the MAC address for the *Bluetooth* interface. The MAC can be used to identify the equipment when it is located by the smartphone, if the SSID has not yet been configured.

BLUETOOTH

- **Enable Bluetooth:** allows to enable/disable the Bluetooth interface.
- **SSID Bluetooth:** allows you to configure name with up to 8 characters for the *Bluetooth* interface. The SSID can be used to identify the equipment when it is located by the smartphone. It is recommended that each **LogBox-BLE** be configured with a different SSID.
- **Wake Up Mode:** allows you to configure how the *Bluetooth* interface should become available for connection to smartphones.
 - **Periodic:** in this configuration, the *Bluetooth* interface is always available so that a smartphone can be connected.
 - **Frequency:** allows you to configure, in milliseconds, how often the equipment will make the *Bluetooth* interface available for connection. The minimum frequency is 500 milliseconds and the maximum are 4 seconds.
 - **Keyboard:** in this configuration, every time a key is pressed the *Bluetooth* interface will become available for a smartphone to be connected. In this mode, the *Bluetooth* interface will be available for 1 minute, becoming available again each time a key is pressed.

DISPLAY

- **Active Display:** allows you to configure when the display should become active.
 - **Always:** in this configuration the display will always be active, following the configured contrast and update interval.
 - **Via Keyboard:** in this configuration, the display is activated every time a key is pressed, being active for 1 minute until a key is pressed again. In this configuration, the configured contrast is followed.
 - **Never:** in this configuration, the display will always be turned off.
 - **Contrast:** allows you to configure the display contrast level. There are 8 levels of contrast where the lowest level streamlines viewing at the upper and lower viewing angles and the higher-level streamlines viewing at the front viewing angle.
 - **Update Interval:** allows you to configure how often the display information is updated.
 - **Use Log Interval:** if configured in this way, the display information is updated at each log interval.
 - **Interval:** allows you to configure a display update interval in seconds that is smaller than the log interval. This way, the input channels will be read and will update the display at this interval. The minimum interval is 1 second and the maximum interval is 18 hours.

CLOCK

- **Date/Time:** Date/Time that will be used to configure the equipment's clock.
- **GMT:** allows you to configure the GMT of the place where the equipment will be used. **LogBox-BLE** is factory-configured with GMT 0. Therefore, the GMT must be configured correctly on the first use.
- **Date/Time Format:** allows you to configure the clock format to 24 hours or AM/PM.

10.3.2 ANALOG CHANNELS PARAMETERS

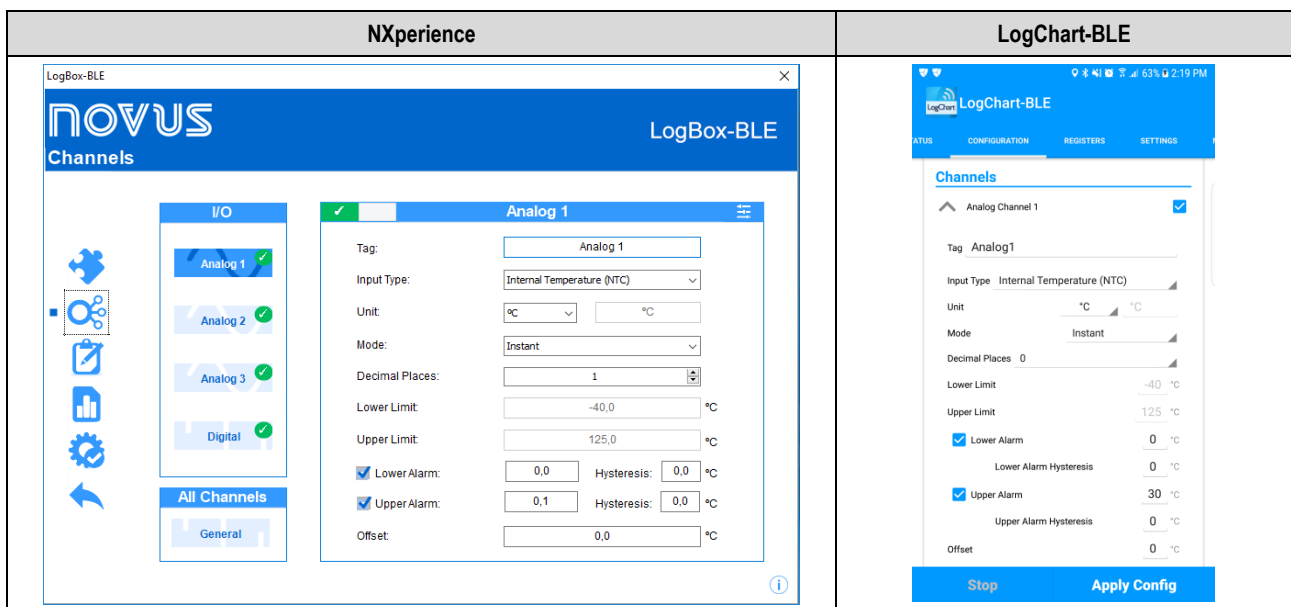



- **Tag:** allows you to configure a 16-character name for each analog channel. This name will be used to identify the channels in a data download.
- **Input Type:** allows you to configure the sensor type that will be used in each analog channel.
- **Unit:** allows you to configure the unit for each analog channel. In the case of temperature sensors, it is possible to select the units °C or °F. For other sensors, it is possible to describe the unit with up to 8 characters.
- **Mode:** allows you to configure which operation mode to use for each analog channel. If Instantaneous is selected, the channel is read, and the value is logged at each log interval. If Average is selected, the equipment will take 10 channel readings within the log interval and at each log interval the average of these 10 readings will be logged.
- **Decimal Places:** allows you to configure the number of decimal places of each analog channel. Temperature Sensors can be configured to show up to one decimal place. Other sensor types can be configured to show up to two decimal places.
- **Lower Limit:** If the sensor configured for the channel is a temperature or internal diagnostic sensor, the lower limit is filled by the software with the sensor lower limit. If the sensor configured for the channel is of the linear sensor type (mV, V, or mA), the user must fill in the desired value to represent the minimum value of the chosen sensor.
- **Upper Limit:** If the sensor configured for the channel is a temperature or internal diagnostic sensor, the upper limit is filled by the software with the sensor upper limit. If the sensor configured for the channel is of the linear sensor type (mV, V, or mA), the user must fill in the desired value to represent the maximum value of the chosen sensor.
- **Lower Alarm:** allows you to enable and configure, for each channel, a lower alarm setpoint.
 - **Hysteresis:** allows you to configure a hysteresis for the lower alarm for each channel.
- **Upper Alarm:** allows you to enable and configure, for each channel, an upper alarm setpoint.
 - **Hysteresis:** allows you to configure a hysteresis for the upper alarm for each channel.
- **Offset:** allows you to make small adjustments to the readings for each channel. The configured offset will be added to all readings performed on the configured channel.

CUSTOM CALIBRATION

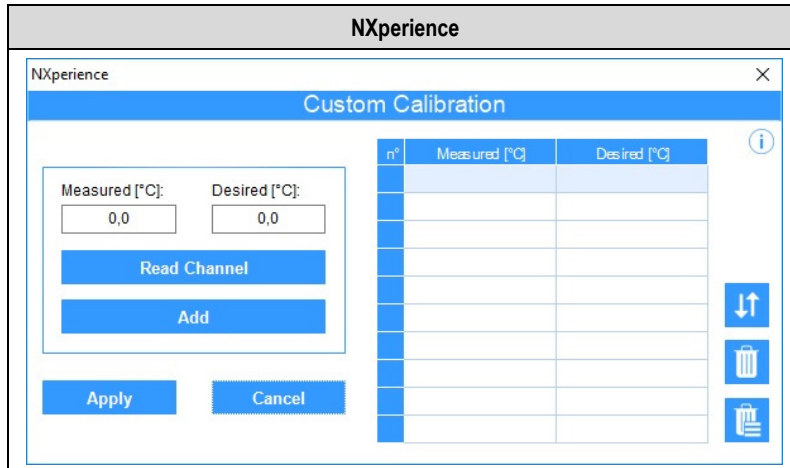
The  icon opens the custom calibration screen, allowing adjustment of up to 10 measurement points for each channel. The minimum number of adjustment points, when a custom calibration is configured, is 2 points.



- **Measured:** equipment read value for which a correction is desired. It can be obtained from the equipment by clicking on the “Read Channel” button or manually filled in.
- **Desired:** desired value for the equipment measured value. It must be filled manually.
- **Read Channel:** makes it possible to obtain the values directly from the equipment during a Custom Calibration.
- **Add:** inserts the Measured – Desired pair into the Custom Calibration table.
- **Modify:** allows you to modify the Measured – Desired pair in the Custom Calibration table.
- **Organize** : allows you to sort the Custom Calibration table.
- **Delete** : allows you to delete the selected line from the Custom Calibration table.
- **Delete All** : allows you to clear the entire Custom Calibration table.
- **Apply:** Applies the custom calibration to the channel being configured.
- **Cancel:** Cancels the Custom Calibration operation.

10.3.3 DIGITAL CHANNEL PARAMETERS

PULSE COUNT MODE

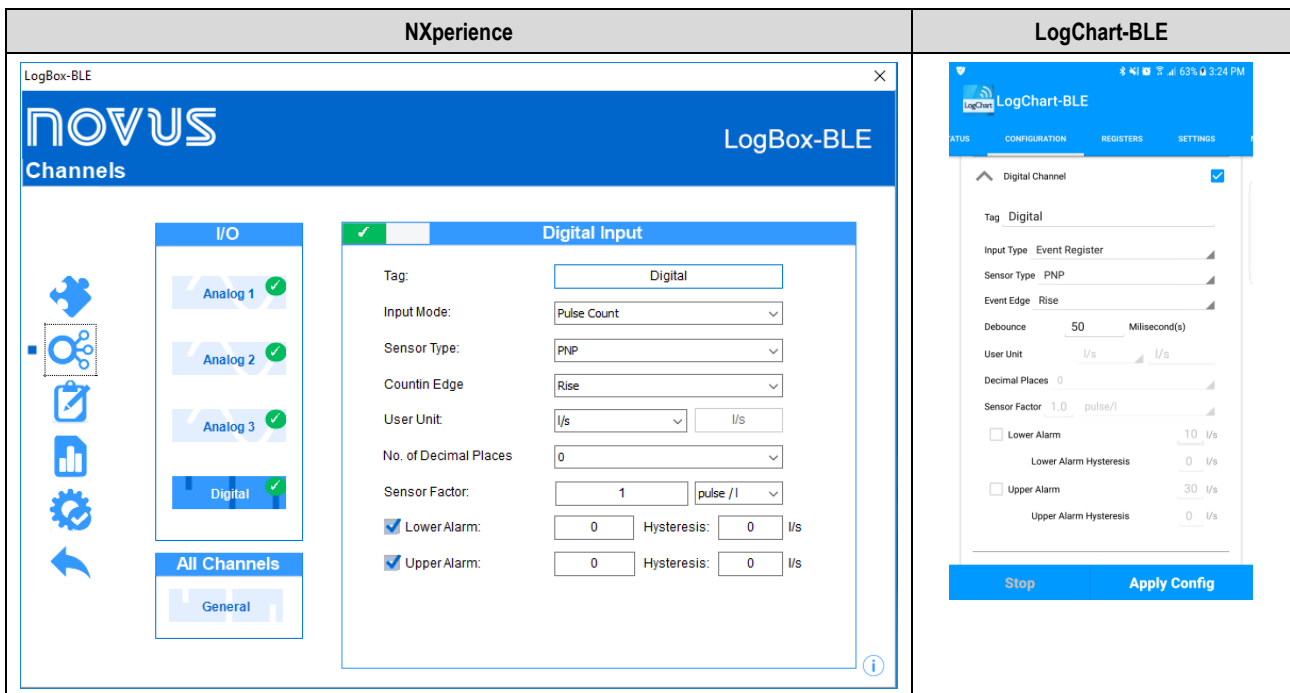

- **Tag:** allows you to configure a 16-character name for the digital channel. This name will be used to identify the channel in a data download.
- **Input Mode:** allows you to select the digital input mode. In this example, the selected mode must be Pulse Count.
- **Sensor Type:** allows you to configure the sensor type to be connected to the digital input: PNP, NPN, or Dry Contact.

- **Counting Edge:** allows you to configure the desired counting edge. This way, the equipment will increment counts each time the configured edge is detected at the digital input. You can configure it to count on the Rising, Falling or Both edges.
- **Debounce:** if the sensor type configured is Dry Contact, it is necessary to set a *debounce* time for edge detection. The *debounce* is the sensor stabilization time - the minimum time at which the sensor must remain at the logical level of interest so that the detected edge is considered valid. The minimum configurable *debounce* time is 50 milliseconds and the maximum are 6 seconds.
- **User Unit:** allows you to configure the flow unit related to the pulses counted in the Digital Input. **LogBox-BLE** provides 9 flow units. If one of them is selected, simply configure the sensor factor together with the sensor unit, so that the equipment calculates the counts and displays the flow rate already on the configured unit. If none of the units provided meets the need, you can select the Custom unit.
 - **Custom:** Allows you to configure a custom unit for the digital input. In this mode it is possible to describe the unit with up to 8 characters. If you configure a custom unit, you need to configure the User Factor.
- **No. of Decimal Places:** allows you to configure the desired number of decimal places to display the calculated value, in flow, of the digital input.
- **Sensor Factor:** allows you to configure the sensor factor used at the digital input. This parameter can be found in the sensor manual as *k-factor*. **LogBox-BLE** provides 3 units for the sensor. If none of the units provided meets the need, you can select the Custom unit.
- **User Factor:** If the User Unit or Sensor Factor unit is set to Custom, you need to configure the User Factor. The User Factor must relate the required unit to the Sensor Unit and the Sensor Factor. It will be used as a factor to be multiplied in the read counts of the digital input. For more details, refer to chapter INPUT SIGNALS READING.
- **Lower Alarm:** allows you to enable and configure a lower alarm setpoint.
 - **Hysteresis:** allows you to configure a hysteresis for the lower alarm.
- **Upper Alarm:** allows you to enable and configure an upper alarm setpoint.
 - **Hysteresis:** allows you to configure a hysteresis for the upper alarm.

EVENT LOG OR LOG CONTROL MODE

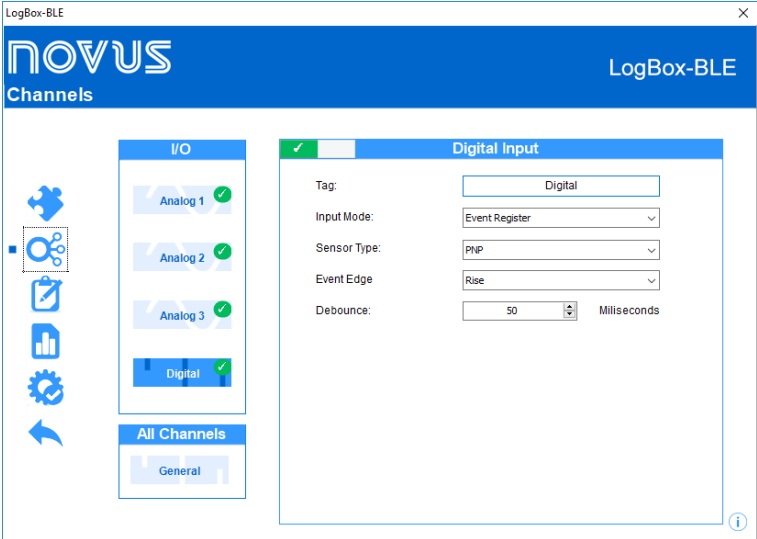
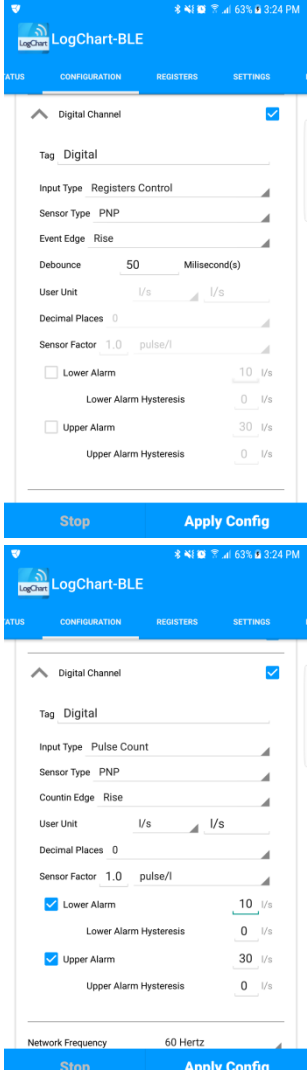
NXperience	LogChart-BLE
	

- **Tag:** allows you to configure a 16-character name for the digital channel. This name will be used to identify the channel in a data download.
- **Input Mode:** allows you to select the digital input mode. In this example, the selected mode must be Event Log or Log Control. If you select the Log Control mode, in the DATA LOGGING setting, the Start and/or Stop of Logs mode via Digital Input must be selected for the configuration to take effect.
- **Sensor Type:** allows you to configure the sensor type to be connected to the digital input: PNP, NPN, or Dry Contact.

- **Event Edge:** allows you to configure the desired event edge. This way, the equipment will log events each time the configured edge is detected at the digital input. In Event Log mode you can configure to log on the Rising, Falling or Both edges. In the Log Control mode, it is possible to select to control logs in the Rising, Falling, Both edges - Logs at logical level '1' or Both - Logs at logical level '0'.
- **Debounce:** it is necessary to configure a *debounce* time for edge detection. The *debounce* is the sensor stabilization time - the minimum time at which the sensor must remain at the logical level of interest so that the detected edge is considered valid. The minimum configurable *debounce* time is 50 milliseconds and the maximum are 6 seconds. The equipment will only register the event after the end of the *debounce* time. Thus, the event will be logged with a delay equal to the *debounce* time.

10.3.4 CHANNELS' GENERAL PARAMETERS

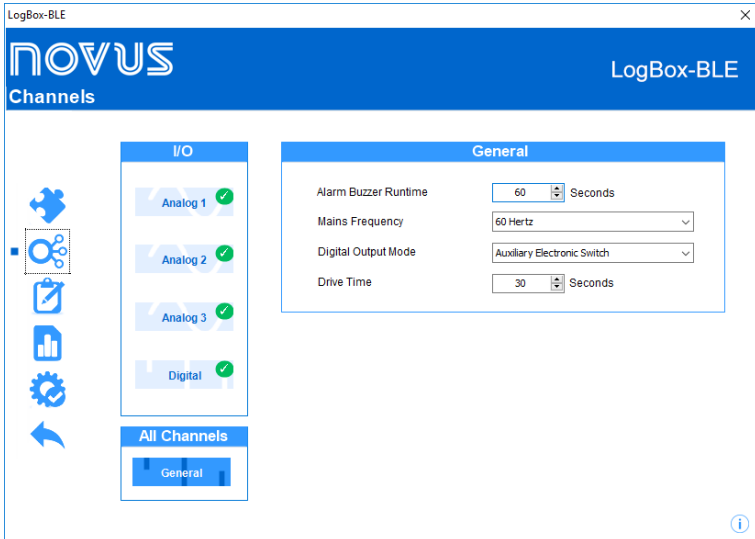
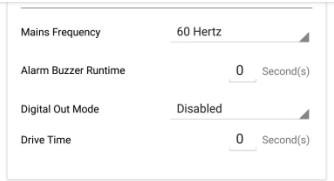
NXperience	LogChart-BLE
	

- **Alarm Buzzer Runtime:** allows you to configure the *buzzer* runtime for each time the equipment enters an alarm situation. The configuration is performed in seconds, from 0 to 65000 s, where 0 means that the *buzzer* should not be triggered.
- **Mains Frequency:** must be set to the frequency of the local power grid (50 Hz or 60 Hz) for the equipment to perform better.
- **Digital Output Mode:** allows you to configure the Digital Output mode. The Digital Output can be configured to Disabled, Auxiliary Electronic Switch, or Alarm Status.
 - **Auxiliary Electronic Switch:** controls the power supply of external instruments during analog channel readings.
 - **Drive Time:** allows you to configure, in seconds, in the Auxiliary Electronic Switch mode, how long before each acquisition the Digital Output must be triggered. The minimum configurable time is 0 seconds and the maximum time is 15 minutes (900 seconds). If equal to 0, the Auxiliary Electronic Switch will be enabled at the exact moment of an acquisition. If greater than or equal to the lowest acquisition interval, the Auxiliary Electronic Switch will always be enabled.
 - **Alarm Status:** in this mode, the Digital Output will follow the current general alarm status. If any channel is in an alarm situation, the Digital Output is triggered. If no channel is set to alarm, the Digital Output is disabled.

10.3.5 DATA LOGGING CONFIGURATION

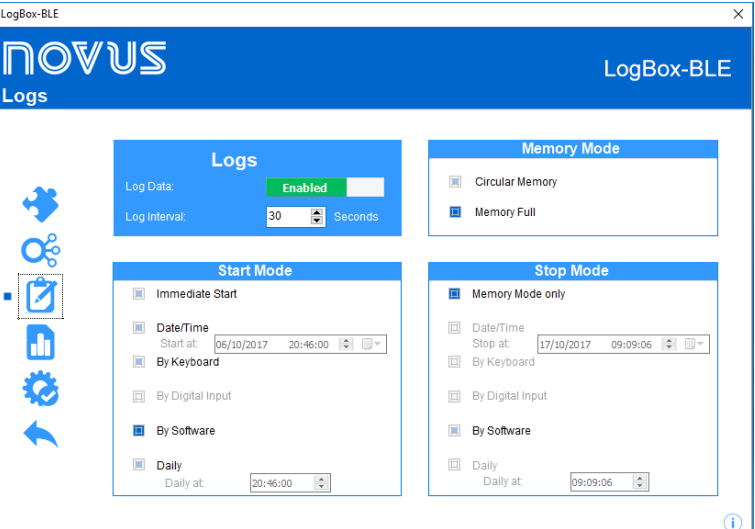
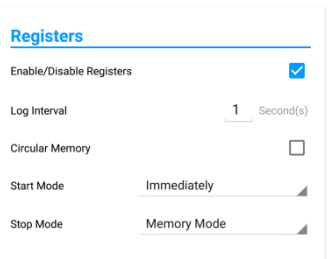
NXperience	LogChart-BLE
	

LOGS

- **Log Data:** allows you to enable or disable data logging on the equipment.
- **Log Interval:** allows the user to select the frequency, in seconds, with which an acquisition must be made and logged in the memory.
 - Minimum Interval:
 - 1 second - if no channel is configured to operate on average;
 - 10 seconds - if a channel is configured to operate on average.
 - Maximum Interval: 18 hours.

MEMORY MODE

- **Circular Memory:** allows you to select so that the equipment continuously logs in memory. When the memory is full, the oldest data will be erased so that the most recent data can be saved.
- **Memory Full:** allows you to select the equipment to pause records when the internal memory has no more available space.

START MODE

- **Immediate Start:** allows you to select to have the logs started shortly after the equipment is reconfigured.
- **Date/Time:** allows configuring the date/time at which the logs are to be started.
- **By Keyboard:** allows you to enable a screen in the display where you can change the status of registrations to *enabled*. Therefore, the logs will be started at that time.
- **By Digital Input:** allows you to configure it so that the logs start from the digital input. This parameter is only available if the digital input is enabled and configured for Log Control, so that the logs are started the moment the digital input is triggered. The log edge shall be configured in the digital input parameters.
- **By Software:** provides permission for the logs to be started by a command from **LogChart-BLE** or **NXperience**.
- **Daily:** allows a schedule to be configured so that logs are started every day at the configured time. A Daily log start mode also requires a Daily log end mode.

STOP MODE

- **Memory Mode Only:** allows the configuration chosen for the Memory Mode to dictate the logs behavior: if Full Memory is chosen, the logs will end as soon as there is no more memory space; if Circular Memory is chosen, the logs will continue indefinitely.
- **Date/Time:** allows the user to configure the date/time at which the logs are to be stopped.
- **By Keyboard:** allows you to enable a screen in the display where you can change the status of registrations to *disabled*. Therefore, the logs will be stopped at that time.
- **By Digital Input:** allows you to configure so that the logs are stopped from the digital input. This parameter is only available if the digital input is enabled and configured for Log Control, so that the logs are stopped the moment the digital input is triggered. The log edge shall be configured in the digital input parameters.
- **By Software:** provides permission for the logs to be stopped by a command from **LogChart-BLE** or **NXperience**.
- **Daily:** allows a schedule to be configured so that logs are stopped every day at the configured time. A Daily log stop mode also requires a Daily log start mode.

The combinations allowed for starting and ending logs are as follows:

Start Mode	End Modes
Immediate	Memory Mode or Date/Time or Keyboard or Software or Digital Input
Date/Time	Memory or Date/Time or Keyboard or Software or Digital Input
Digital Input	Memory or Digital Input
Keyboard	Memory or Keyboard
Software	Memory or Software
Daily	Daily

Table 07 – Logs stop modes

10.4 DIAGNOSTICS

On the **LogBox-BLE** configuration screen (**NXperience** only), the Diagnostics option is available. By clicking on this screen, the software starts to monitor some states of the equipment to inform the user. The information update interval on the diagnostics screen is 1 second. Below is more detail of monitored information.

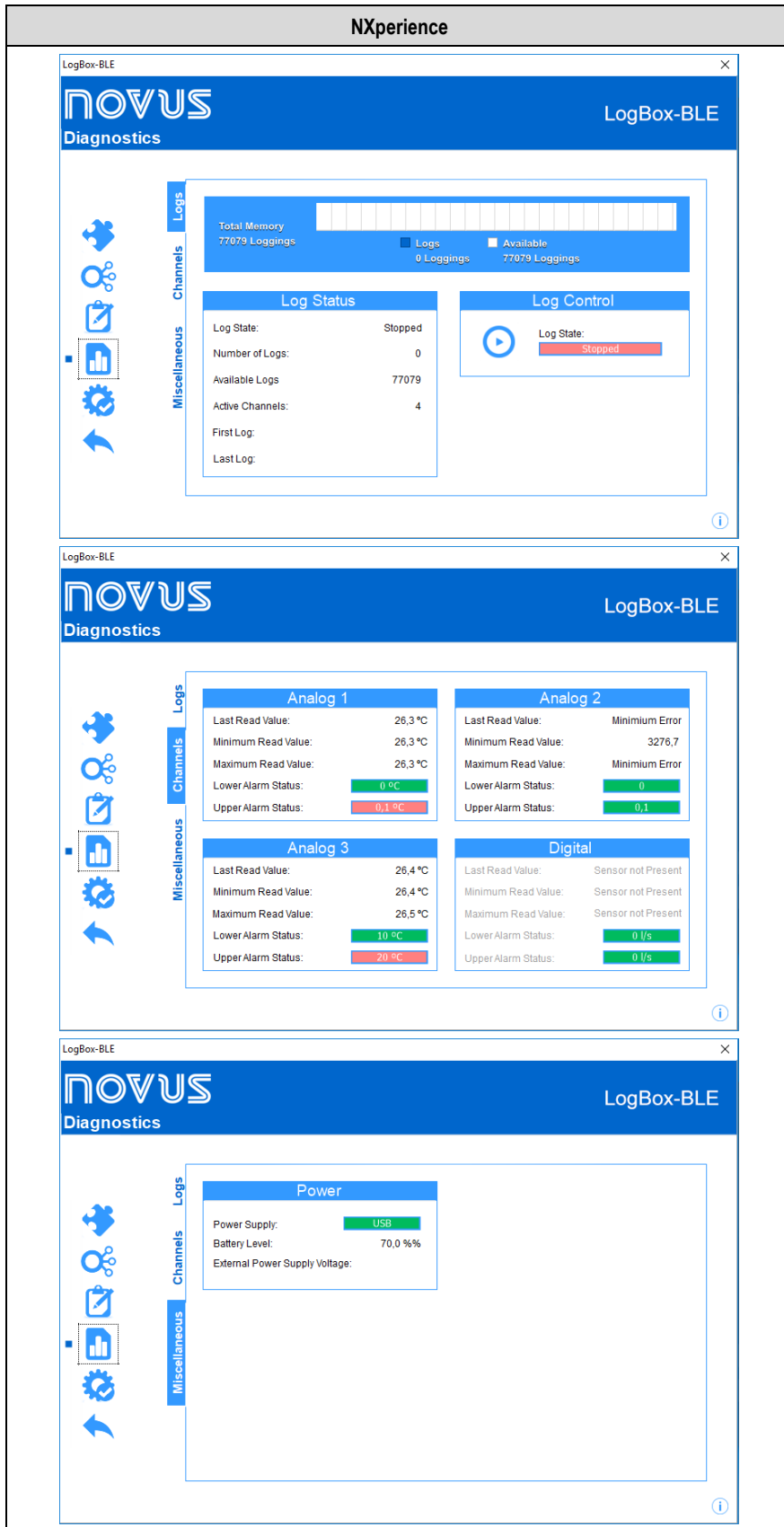

10.4.1 LOGS

- **Log Status:** Displays information about log status, such as number of logs recorded, available memory, number of active channels, and date of the first and last logs in the **LogBox-BLE** memory.
- **Log Control:** Allows the user to start or stop **LogBox-BLE** data logging. For this option to be active, the log start and/or stop mode must be configured with the By Software option.

10.4.2 CHANNELS

- **Analog Channels and Digital Channel:** Displays information about the acquisitions made by the equipment on the analog channel sensors and on the digital channel sensor.
 - **Last Read Value:** Displays the value of the last acquisition performed by the equipment on the corresponding channel sensor. The displayed value may have been updated by a display update frequency and not logged in the memory.
 - **Minimum Read Value:** Displays the minimum read value by the equipment on the corresponding channel sensor. The displayed value may have been read by a display update frequency and not logged in the memory.
 - **Maximum Read Value:** Displays the maximum value read by the equipment on the corresponding channel sensor. The displayed value may have been read by a display update frequency and not logged in the memory.
 - **Lower Alarm Status:** Displays the configured minimum alarm setpoint information and if the equipment has entered a minimum alarm condition on the corresponding channel. The alarm may have been detected by a display update frequency and not logged in the memory.
 - **Upper Alarm Status:** Displays the configured maximum alarm setpoint information and whether the equipment has entered the maximum alarm condition on the corresponding channel. The alarm may have been detected by a display update frequency and not logged in the memory.

10.4.3 MISCELLANEOUS

- **Power:** Displays power information monitored by the equipment.
 - **Power Supply:** Displays the current power supply of the equipment.
 - **Battery Level:** Displays the current battery level status. This information is updated in the logs frequency with a minimum frequency of 5 minutes.
 - **External Power Supply Voltage:** Displays the external power supply voltage of the equipment. This information is updated in the logs frequency with a minimum frequency of 5 minutes.

10.5 LOGCHART-BLE SPECIFIC FEATURES

10.5.1 INSTALLING THE APPLICATION

To install the app, search *Google Play Store* for **LogChart-BLE**. After the *download* is complete, open the application. If your smartphone does not support the BLE technology or runs an *Android™* version lower than 4.4, the app will not be available on *Google Play Store*.

10.5.2 APPLICATION OPERATION

Communication of the application with **LogBox-BLE** is done through the smartphone *Bluetooth* interface and, therefore, must be enabled in it. If *Bluetooth* has not been enabled, the application will ask for permission to enable it.

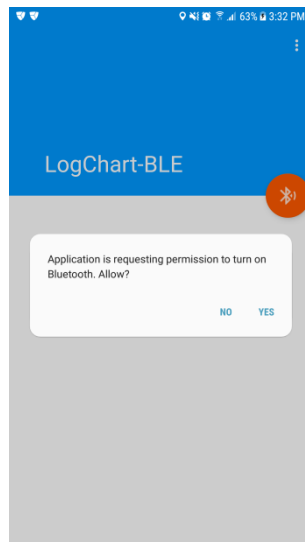



Fig. 02 – Permission to enable *Bluetooth*

The device's home screen basically consists of a configuration button in the upper right corner and a search button  which displays all devices available for connection:

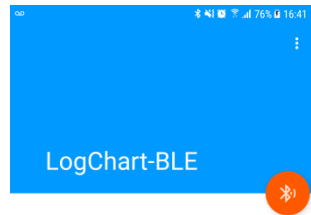

Fig. 03 – Application initial screen

To make the connection, the search button must be pressed, remembering that **LogChart-BLE** must be within the maximum allowed distance to the smartphone, the allowed distance is specified in chapter COMMUNICATION INTERFACES.

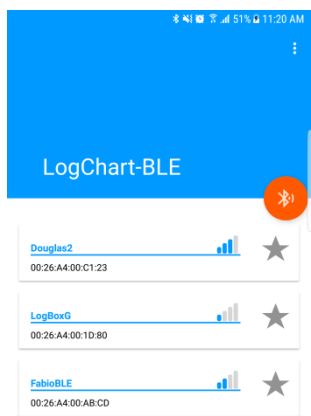

Fig. 04 – Devices selection for connecting

After the application has been started (see **Fig. 04**) it is possible to select the device to be connected. After selecting the device, it typically takes a few seconds for the connection to be made, which is very dependent on the *smartphone* model used.

In the device selection screen, a SSID will appear for each **LogBox-BLE**, which is the name given to the device. Below the SSID are the **LogBox-BLE Bluetooth MAC** and the *Bluetooth* signal quality.

You can also select a favorite device so that the connection is automatically made the next time you use the application. To do this, simply select the star next to the device ★.

To make the device no longer a favorite, plug it in and press the back button back to the home screen and press on the selected star as favorite and the icon will turn gray again, ★ thus, deselecting the device as a favorite.

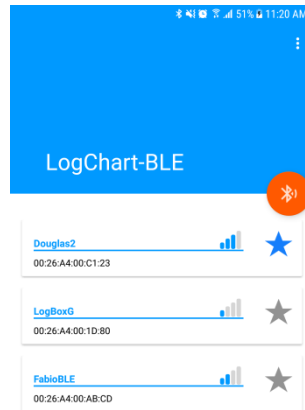

Fig. 05 – Favorite device

After equipment selection, the application will read the settings and make them available to the user in five screens as follows:

- **Device Status:** Provides information about the equipment, such as log status, number of logs available, serial number, equipment firmware version, etc.
- **Device Configuration:** Here you can configure the equipment parameters, create or change access passwords, start or stop logs.
- **Logs:** It gives the user the ability to perform data downloads from the memory of the connected equipment. These data are shown graphically and analytically, showing alarm events that occurred during the downloaded period.
 - **Events:** Shows alarm event information for each channel.
 - **Data Chart:** Shows the data downloaded in a chart.
- **Preferences:** Provides some application options for the user.
- **Dara Download Manager:** Tool to manage the performed downloads.

10.5.3 STATUS SCREEN

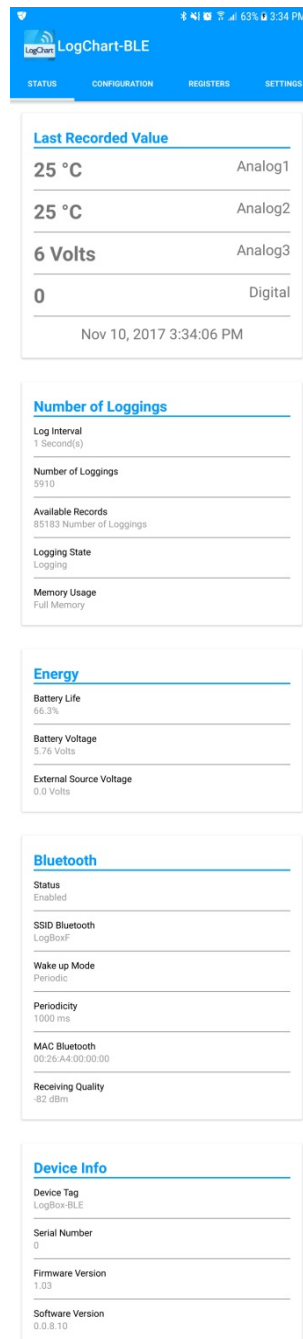

Fig. 06 – Status screen

- **Last Read Value:** Displays the value of the last acquisition performed by **LogBox-BLE** for each channel. The last acquisition may not have been recorded in memory
- **Logs:** Indicates basic information about **LogBox-BLE** logs.
 - **Interval between Logs:** Indicates the value for the configured log interval.
 - **Logs:** Number of logs made by **LogBox-BLE**.
 - **Log State:** Indicates if it is logging or stopped.
 - **Memory Mode:** Indicates the type of memory configured (full or circular).
- **Power:** Indicates information about the possible power supplies for **LogBox-BLE**.
 - **Battery Life:** Indicates the remaining battery percentage.
 - **Battery Voltage:** Indicates the battery voltage in Volts.
 - **External Power Supply Voltage:** Indicates external power supply voltage in Volts.

- **Bluetooth:** Show the *Bluetooth* configurations.
 - **Status:** To read the information through the application, the *Bluetooth* must be enabled, so, the status will always be enabled.
 - **SSID Bluetooth:** Displays the name given to the device for *Bluetooth* connection.
 - **Wake Up Mode:** Indicates whether the *Bluetooth* wake-up mode is via keyboard or periodic.
 - **Frequency:** Displays the configured frequency for the periodic wake up mode.
 - **MAC Bluetooth:** Shows the device's MAC address.
 - **Reception Quality:** Displays, in dBm, the signal power of the connected device (this value is obtained at the time of the search on the home screen, i.e., this value is not updated periodically).
- **Device Information:** Indicates specific **LogBox-BLE** information.
 - **Device Name:** Name configured by the user.
 - **Serial Number:** Serial Number factory-engraved.
 - **Firmware Version:** Device's *Firmware* Version.
 - **Software Version:** Application version.

10.5.4 CONFIGURATION SCREEN

All the configuration screens available through **LogChart-BLE** are common to the **NXperience** screens. Thus, they are explained in the CONFIGURING WITH NXperience / LogChart-BLE section.

10.5.5 LOG SCREEN

Upon moving to log screen, a new connection to **LogBox-BLE** will occur for data download purposes. If you accidentally opened the screen, simply slide your finger on it and the reconnection will be canceled automatically.

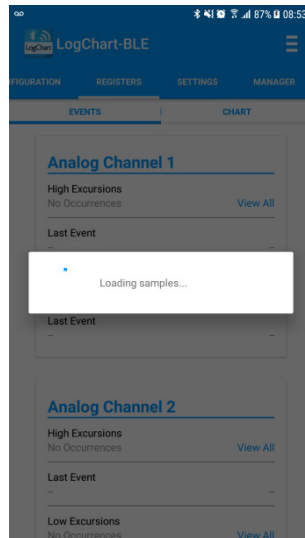

Fig. 07 – Log screen

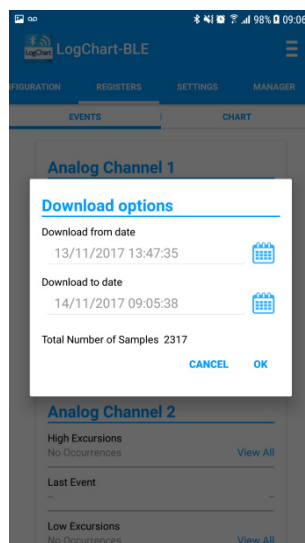

Fig. 08 – Period selection for connecting

After connecting to the device, a selection screen for the download period will be available. In the “Download from date” field, the application automatically fills in with the date/time of the first log and, in the “Download until date” field, the application is filled with the most recent log date/time. It is possible to change date dates freely as long as there are logs in the chosen period.

There is no log limit for the data download, however, the more logs downloaded, the longer the data download process takes and the greater the consumption of the equipment during download. This time depends on the quality of the *Bluetooth* connection between smartphone and **LogBox-BLE**. For a satisfactory experience, it is suggested to divide a very large data download into two or more steps.

A typical download, smaller than 3000 logs, lasts around 60 seconds. A full memory download, for example, can take more than 20 minutes to be completed. Both times of download duration depending on the *Bluetooth* signal quality. If the download is slow, it is recommended to bring the smartphone closer to the **LogBox-BLE** that is being downloaded.

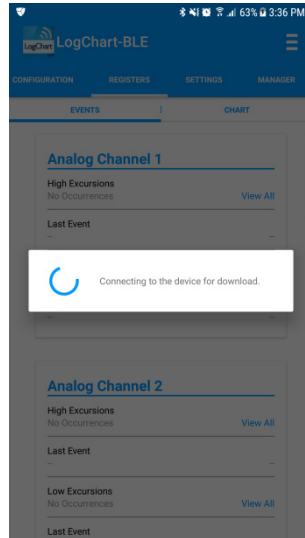

Fig. 09 – Collecting the LogBox-BLE

If **LogBox-BLE** does not have logs, the application displays the message shown below.

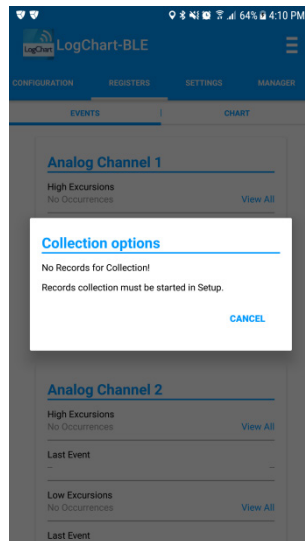

Fig. 10 – LogBox-BLE without logs

EVENTS

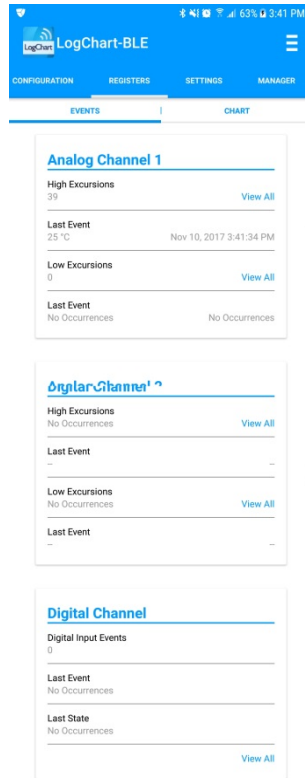

Fig. 11 – Event screen

For each channel enabled in **LogBox-BLE** you can view the following events:

- **High Excursions:** Allows you to view all records where the measured value has exceeded the maximum alarm setpoint.
- **Last Event:** Displays the time and value of the last occurrence above the maximum alarm setpoint.
- **Low Excursions:** Allows you to view all logs where the measured value has exceeded the minimum alarm setpoint.
- **Last Event:** Displays the time and value of the last occurrence below the minimum alarm setpoint.

OCCURRENCE SCREEN

By pressing the “See All” icon, the user can view all logs where the value was below the minimum alarm setpoint or above the maximum alarm setpoint, showing the value and time of the event/occurrence, as shown in **Fig. 12** and **Fig. 13**.

If there are no occurrences in High Excursions or Low Excursions, they will appear in the messages of **Fig. 14** and **Fig. 15**.

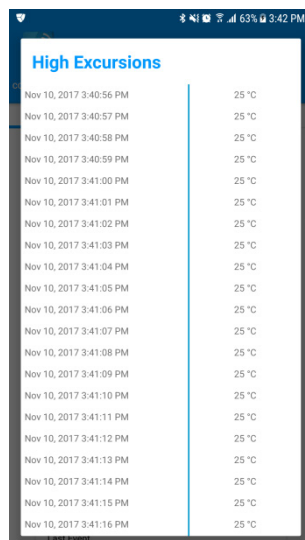

Fig. 12 – High temperature excursions occurrence screen

Timestamp	Temperature
Nov 10, 2017 3:43:39 PM	25 °C
Nov 10, 2017 3:43:40 PM	25 °C
Nov 10, 2017 3:43:41 PM	25 °C
Nov 10, 2017 3:43:42 PM	25 °C
Nov 10, 2017 3:43:43 PM	25 °C
Nov 10, 2017 3:43:44 PM	25 °C
Nov 10, 2017 3:43:45 PM	25 °C
Nov 10, 2017 3:43:46 PM	25 °C
Nov 10, 2017 3:43:47 PM	25 °C
Nov 10, 2017 3:43:48 PM	25 °C
Nov 10, 2017 3:43:49 PM	25 °C
Nov 10, 2017 3:43:50 PM	25 °C
Nov 10, 2017 3:43:51 PM	25 °C
Nov 10, 2017 3:43:52 PM	25 °C
Nov 10, 2017 3:43:53 PM	25 °C
Nov 10, 2017 3:43:54 PM	25 °C
Nov 10, 2017 3:43:55 PM	25 °C
Nov 10, 2017 3:43:56 PM	25 °C
Nov 10, 2017 3:43:57 PM	25 °C
Nov 10, 2017 3:43:58 PM	25 °C
Nov 10, 2017 3:43:59 PM	25 °C

Fig. 13 – Low temperature excursions occurrence screen

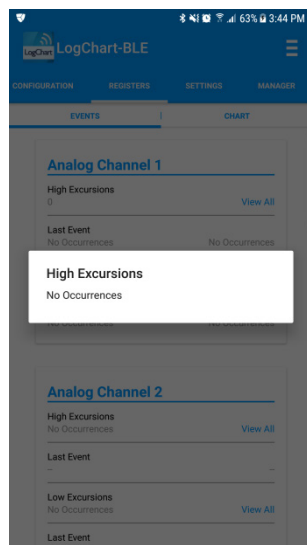

Fig. 14 – High excursions message “No Occurrences”

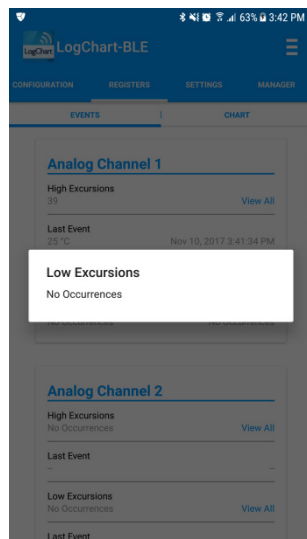

Fig. 15 – Low excursions message “No Occurrences”

CHART



Fig. 16 – Chart screen

This screen allows the user to view the data history at different time ranges in a graphical way. This screen also shows the maximum, minimum, and average recorded value of each channel in the downloaded period.

It is possible for the user to tap on a point on the chart and, thus, check the value and time at that point. The number of logs displayed in the chart is limited to allow better viewing on your smartphone. Each screen displays 500 acquisitions. To navigate the chart and view the other records, you must use the left and right arrows. They will allow you to roll back or advance through 500 acquisitions.

LOG SCREEN OPTION MENU

By pressing the menu icon, in the upper right corner of the screen, illustrated options and described below will appear.

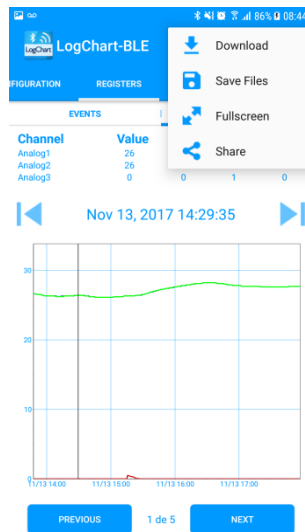



Fig. 17 – Log screen option

Download Logs: By pressing the  icon, the user can perform a data download again. Thus, the previously performed download will be discarded, updating the event and graphic screens, which will always display information from the last download made.

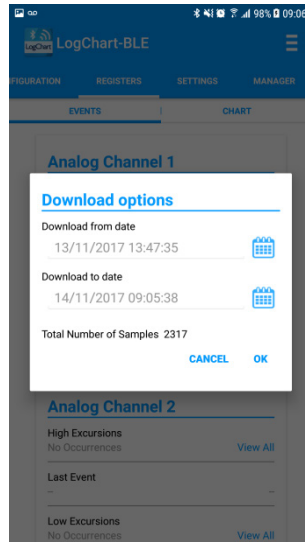



Fig. 18 – Download logs

Save Files: By pressing the  icon, the user can save the downloaded files in the *smartphone* memory. The application will send a message informing that the files have been saved.

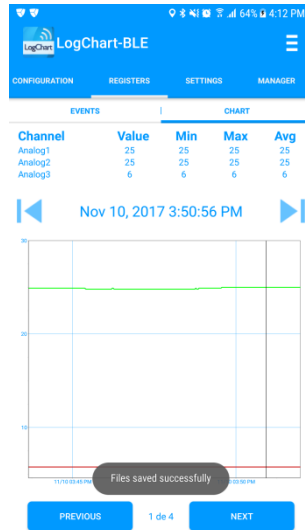

Fig. 19 – Files saved successfully

If the files are already saved in your *smartphone* memory, a message will be sent by the application.

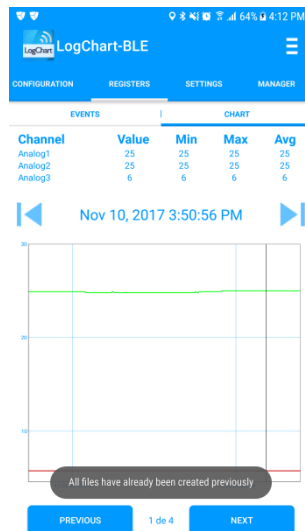



Fig. 20 – Previously created files

Full Screen: By pressing the  icon, the graphic is now displayed in full screen in the landscape format.

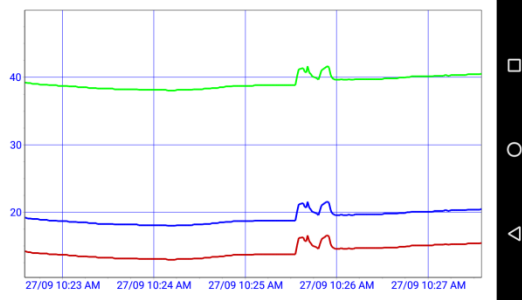



Fig. 21 – Full screen

Sharing: By pressing the  icon, the user can share the downloaded data using sharing applications already installed on the *smartphone*. It is also possible to publish on the **NOVUS Cloud** (this option requires creating an account).

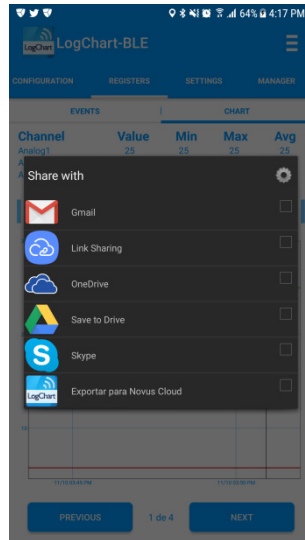

Fig. 22 – Data sharing screen

Just recalling that the files that will be downloaded, saved, and shared will obey the “Default Sharing Options” on **PREFERENCES** screen.

10.6 PREFERENCES SCREEN

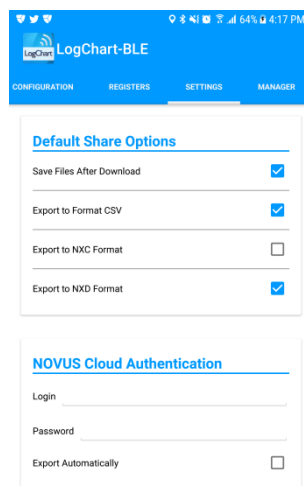

Fig. 23 – Preferences screen

- **Default Sharing Options:** In the preferences screen, the user can configure how they want to share the data downloaded from **LogBox-BLE** managed by **LogChart-BLE**.
 - **Save Files after Download:** Configures the application to save the downloaded files in the *smartphone* internal memory.
 - **Export to CSV format:** Configures the application to share a CSV extension file with all the logs from last download. This file can be opened by using *Microsoft Office Excel*.
 - **Export to NXperience NXC:** Configures the application to share a file with **LogBox-BLE** configuration in a format compatible with **NXperience** (.NXC).
 - **Export to NXperience NXD:** Configures the application to share a file with the downloaded data in a format compatible with **NXperience** (.NXD).

- **NOVUS Cloud Authentication:** Hire an account in the **NOVUS Cloud** to store the **LogBox-BLE** data. Enter your access credentials in the *Login* and *Password* fields to submit the data.
- **Export Automatically:** With this option selected, whenever data is downloaded from a device, the application will attempt to automatically send the data to the **NOVUS Cloud**.

10.7 DATA DOWNLOADS

This screen allows you to erase and share data from previously performed downloads. It displays a list containing all downloads performed and saved by the user, separated by the downloaded **LogBox-BLE** serial numbers. In this list you can select the desired files and share or delete them.

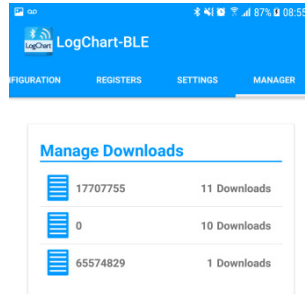

Fig. 24 – Data downloads

By clicking on the desired **LogBox-BLE**, identified by the serial number, **LogChart-BLE** will expand a list containing all saved downloads from that part.

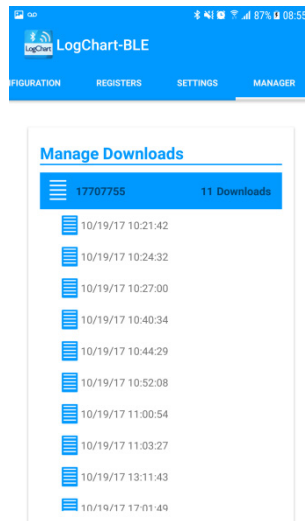

Fig. 25 – Data downloads

To share data, select the desired download file and the  button will be available.

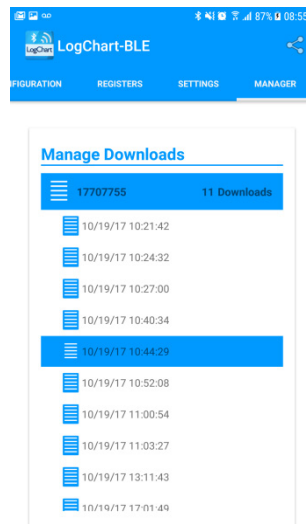



Fig. 26 – Download selection

After that, press the  sharing button and a screen will be opened, allowing you to select the method that you want to use to share the selected download file.

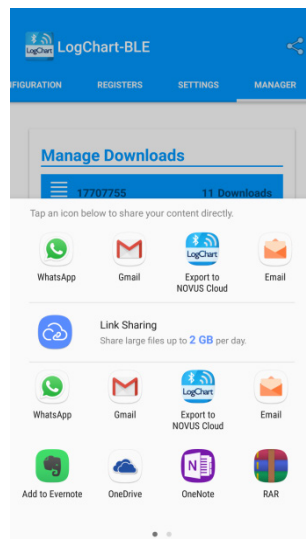



Fig. 27 – Downloaded sharing

To delete the selected item from the list, simply press and hold (long click) to open a *checkbox* to select the download file you want to delete. Once this is done, simply press the  button, for a dialog box to appear asking if the user is sure about the deletion of the selected download file.

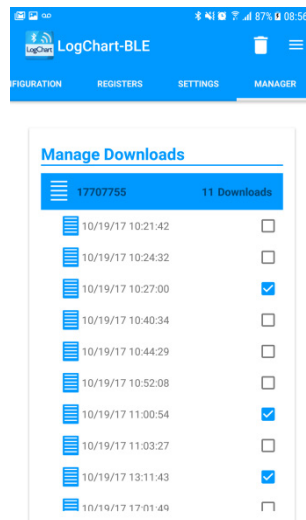



Fig. 28 – Data downloads screen

By pressing the  button, all downloads from the chosen serial number will be selected.

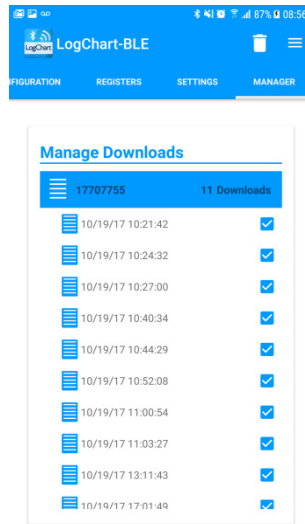

Fig. 29 – Selection of all downloads

It is still possible to delete all downloads from the selected device at the same time. To do this, simply press above the device serial number from which the user wants to delete *smartphone* memory and wait until the exclusion confirmation dialog appears.

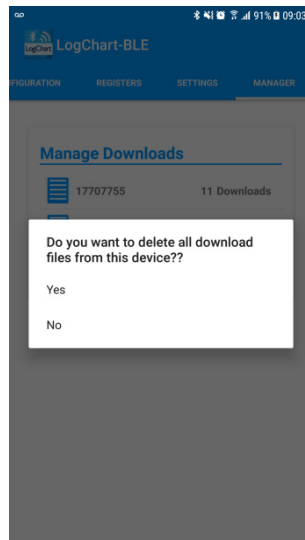

Fig. 30 – Exclusion confirmation

11. INSTALLATION

11.1 MECHANICAL INSTALLATION

LogBox-BLE has a high-quality enclosure built in ABS+PC with IP40 protection rating.

To facilitate the attachment of the **LogBox-BLE**, the product comes with a fixing bracket. It has three oblong holes, arranged in the shape of a triangle, which serve to fix the bracket through screws. This bracket was developed for fixation to any type of wall. Optionally, to facilitate the fixation on metal surfaces, it is possible to purchase a model of the **LogBox-BLE** that comes with a fixing bracket with magnetic inserts.

To assist in the installation aesthetics, two openings in the lower part of the fixing bracket can be used to pass the sensors that are connected to the equipment. In addition to that, this bracket has a ring that allows the placement of a padlock so that **LogBox-BLE** cannot be removed from the installed location.

With the help of two screwdrivers, it is possible to remove and attach the **LogBox-BLE** to the bracket by means of two lateral fittings.

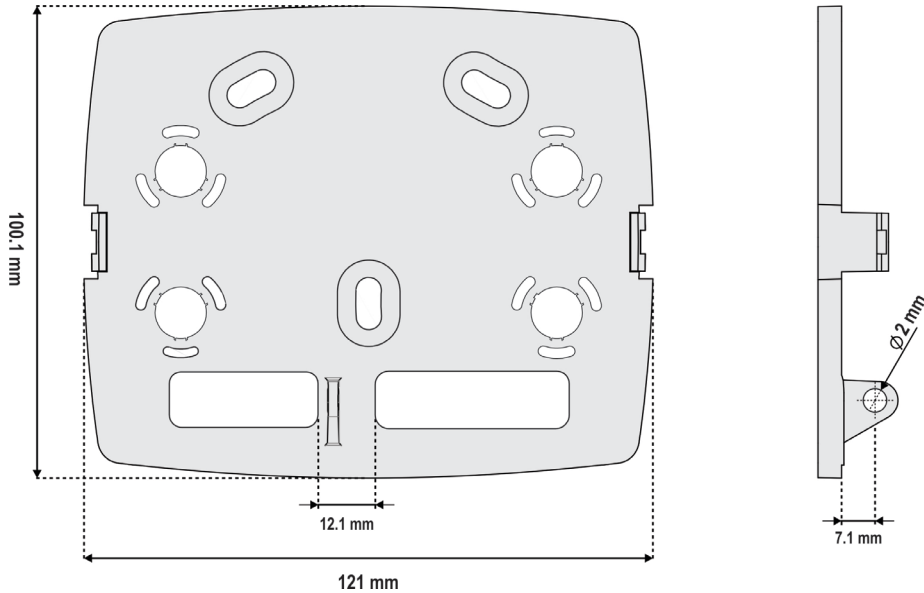

Fig. 31 – Mounting bracket

To improve equipment installation aesthetics, even in cases where several sensors are connected to terminals, **LogBox-BLE** comes with a protection cover for the connections that is dockable in the bottom, hiding the sensors. This protection cover has 4 detachable cavities to facilitate the sensors installation, as needed.

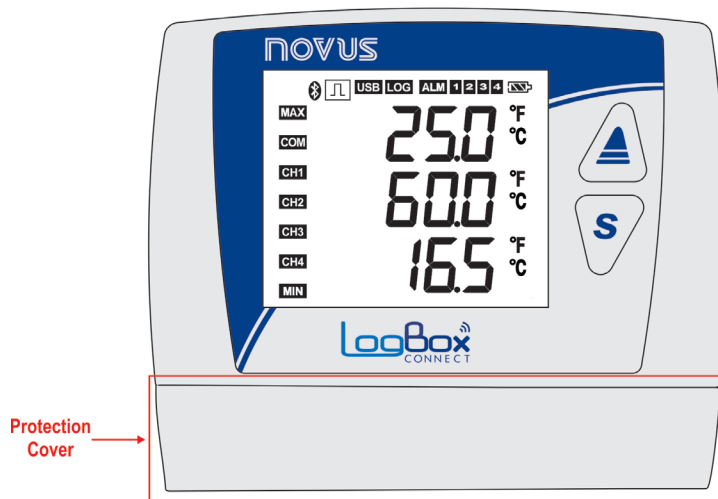

Fig. 32 – Connections protection cover

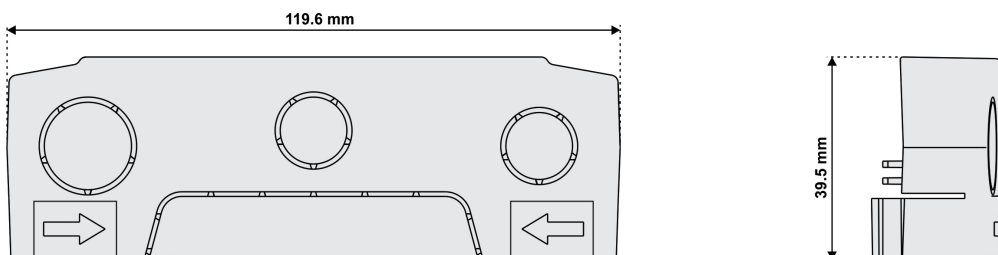

Fig. 33 – Dimensions of the detachable connections and cavities protection cover

To detach the protection cover, press the sides, next to the wall, one side at a time.

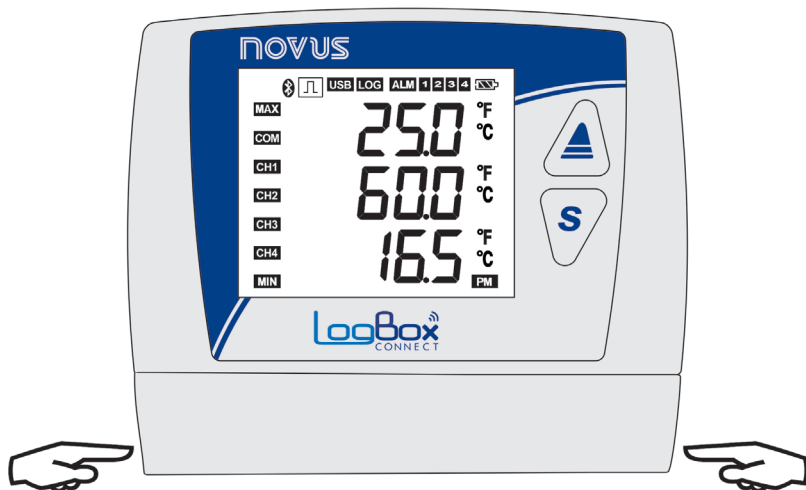

Fig. 34 – Removing the protection cover

To fit the protection cover, bring the cover closer to the product and press the area where the arrows are located by pushing it in from the outside in one side at a time.

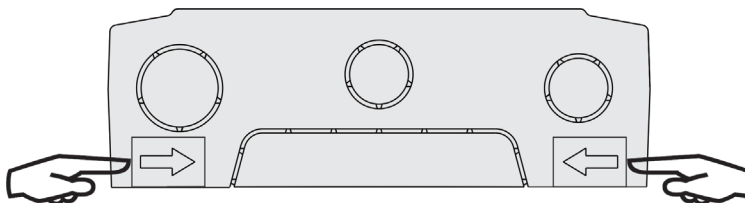

Fig. 35 – Fitting the protection cover

11.1.1 DIMENSIONS

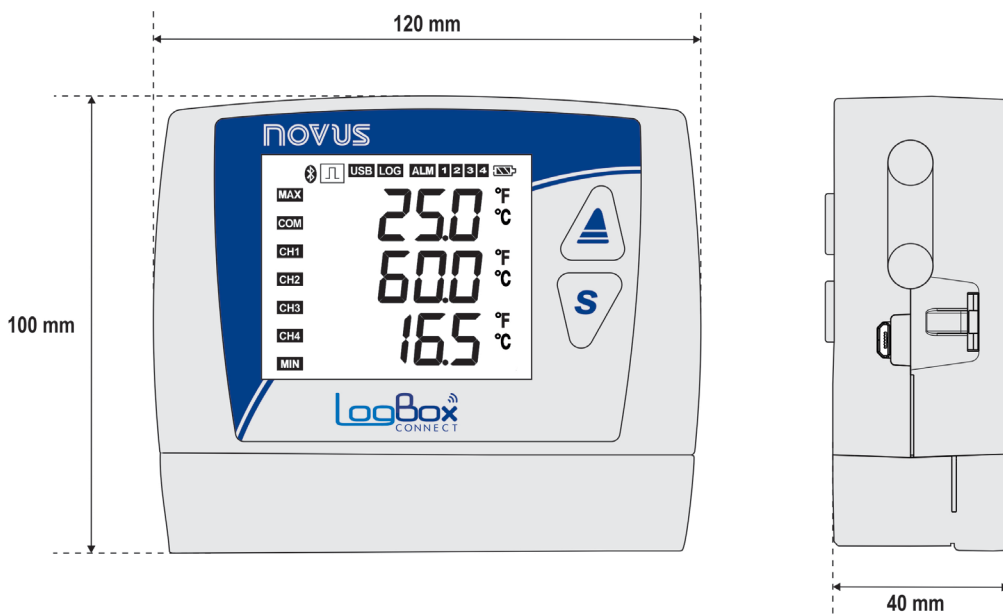

Fig. 36 – LogBox-BLE dimensions

Opening the batteries cover:

To open the battery compartment, press the cover in the arrows region and push in from the inside out.

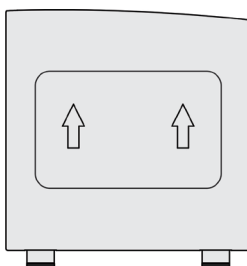

Fig. 37 – Batteries cover

11.2 ELECTRICAL INSTALLATION

11.2.1 INSTALLATION RECOMMENDATIONS

- Electronic and analog signal drivers must run the plant separately from the power supply and output conductors, if possible on grounded conduits.
- The power supply for the electronic instruments must come from a proper power grid for instrumentation.
- It is recommended to use RC FILTERS (noise suppressor) in contactor coils, solenoids, etc.
- In control applications, it is essential to consider what could happen when any part of the system fails. The equipment internal devices do not guarantee full protection.
- The electrical connections must be made with the equipment's marked connection terminals. Before connecting them, make sure that the connections have been made correctly.
- Remember to wrap all wires inside the desired openings for passageways before making any electrical connections.
- The power supply, digital output, digital input, and analog inputs terminals are not isolated from each other. Therefore, analog and digital signals from the same power supply must not be used, otherwise the equipment will malfunction.

11.2.2 SPECIAL CARE

Due to LogBox-BLE being an electronic module, it needs some handling care:

- When opening the cover that provides access to the connector for replacing the batteries, avoid contact with the connection terminals and the electronic circuit due to the risk of damage caused by static electricity.
- The equipment should not be opened due to the risk of damage caused by static electricity when the equipment is exposed to the electronic circuit.
- Pay close attention to the sensor wires, the digital input, the digital output, and the external power supply connections.

11.2.3 ELECTRICAL CONNECTIONS

LogBox-BLE has 4 detachable connection terminals for connection of external power supply, digital output load, digital input sensor, and analog sensors for each of the 3 available analog channels. Fig. 38 illustrates electrical connections in a basic way.

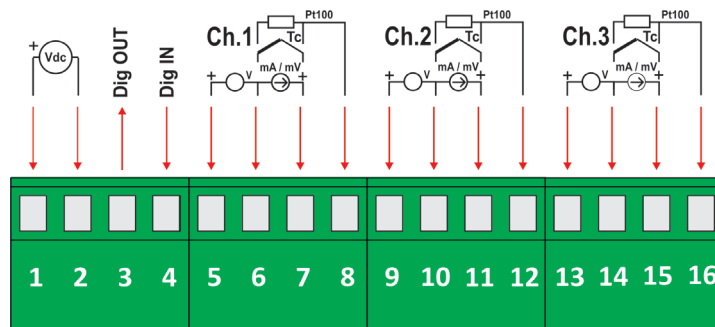

Fig. 38 – Electrical connections

For the sensors connection, it is recommended that the connection terminals be previously detached from the equipment. To streamline the sensors connection, use the enumeration printed on the connectors and the Electrical Connections image in Fig. 38, in the Quick Guide, and in the Connections Protection Cover.



The power supply, digital output, digital input, and analog inputs terminals are not isolated from each other! Therefore, analog and digital signals from the same power supply must not be used, otherwise the equipment will malfunction.

POWER SUPPLY

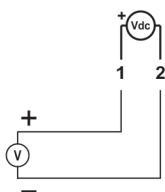

The connection to the Power Supply is made at the terminals according to the following image. The power supply used must be of the direct current type, with a voltage between 10 and 30 V and provide a minimum current of 15 mA when not connected to the digital output. If the load is connected to the digital output, the power supply used must be able to provide current compatible with the load used.

DIGITAL OUTPUT

Alarm Status Mode Connection

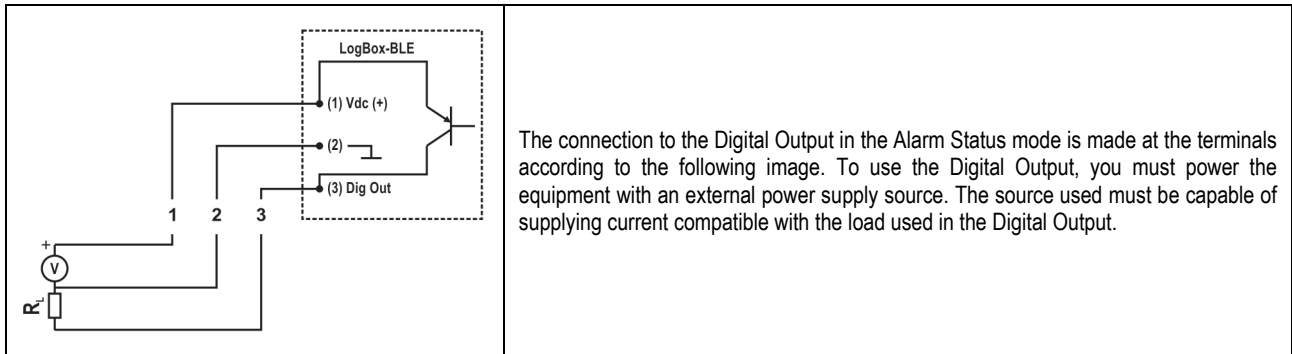

Auxiliary Electronic Switch Mode Connection

The connection to the Digital Output in the Auxiliary Electronic Switch Mode, used to power current transmitters, is made at the terminals according to the figure below. To use the Digital Output, you must power the equipment with an external power supply source. The source used must be able to provide current compatible with the number of transmitters used.

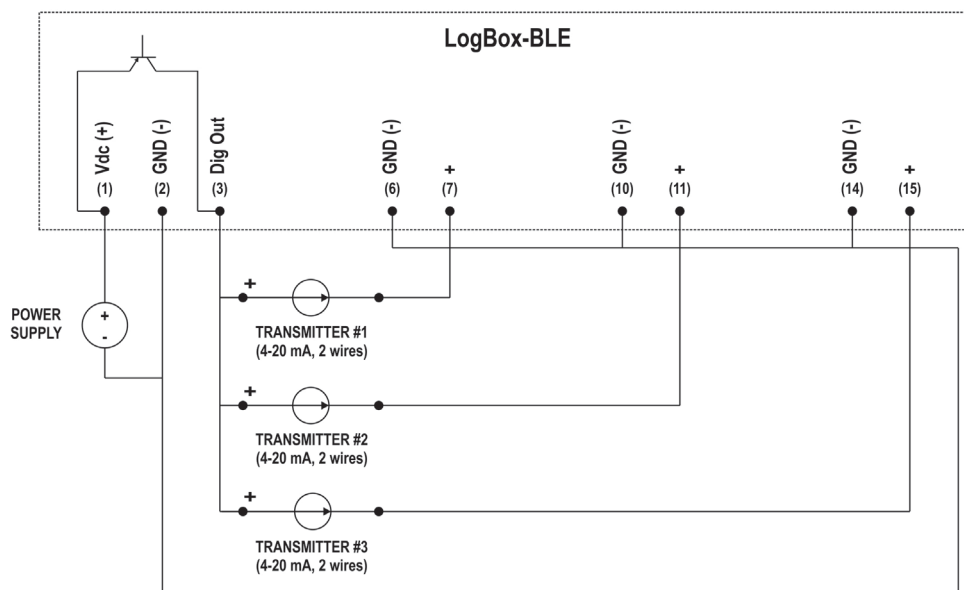
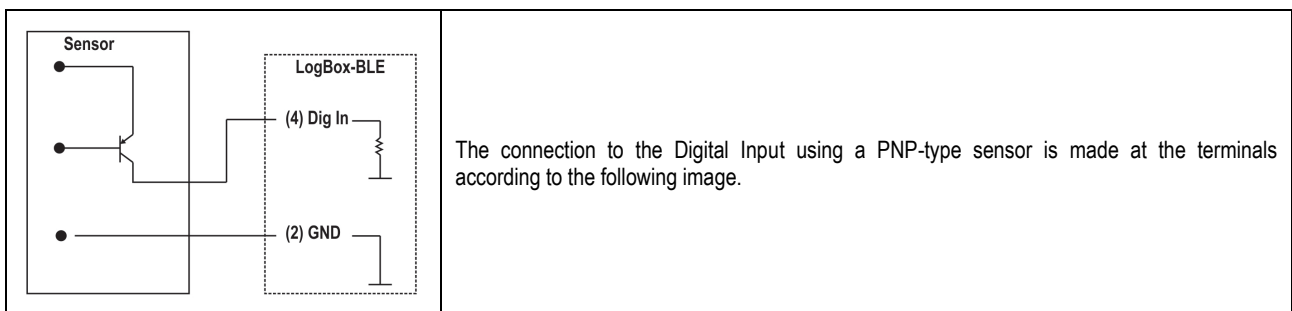

Fig. 39 – Auxiliary electronic switch mode connection

DIGITAL INPUT

PNP Connection



NPN Connection

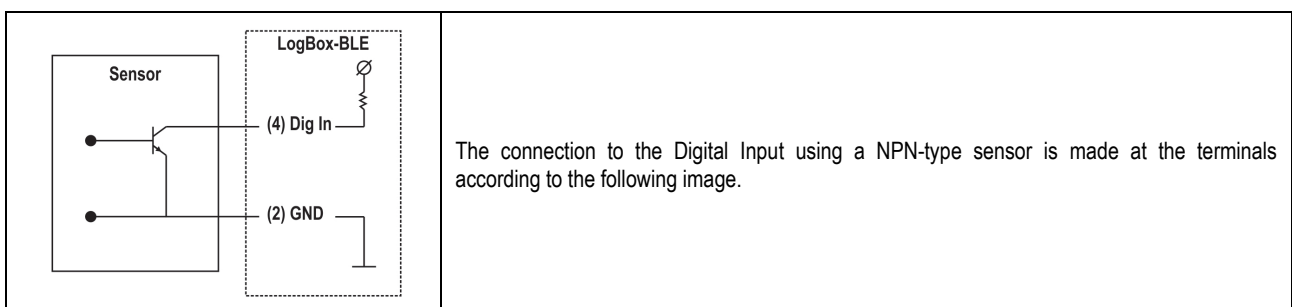

Dry Contact Connection

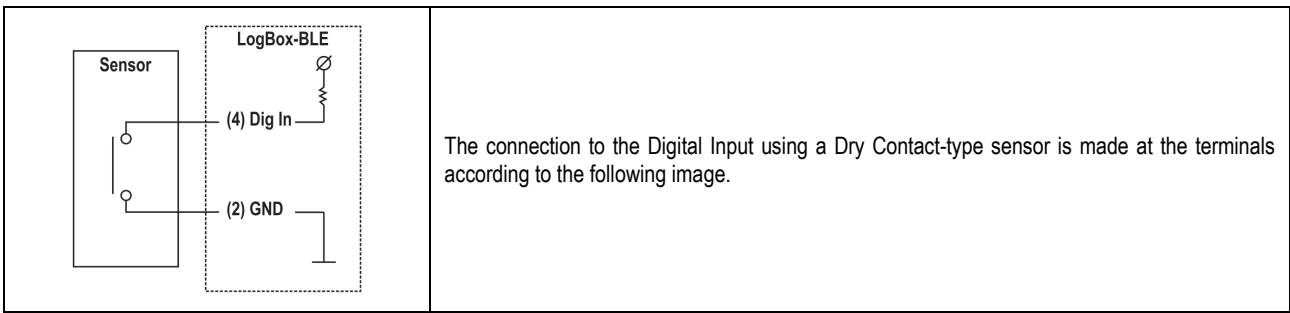

ANALOG INPUTS

Pt100 Connection

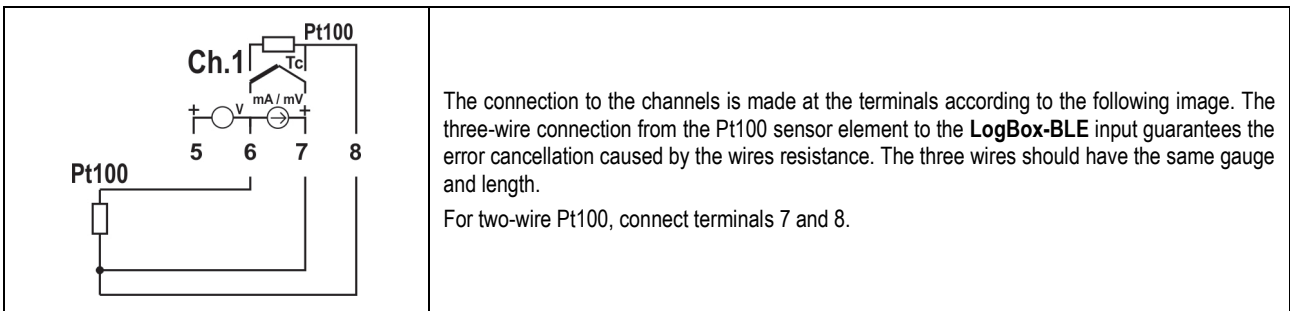

Thermocouples Connection

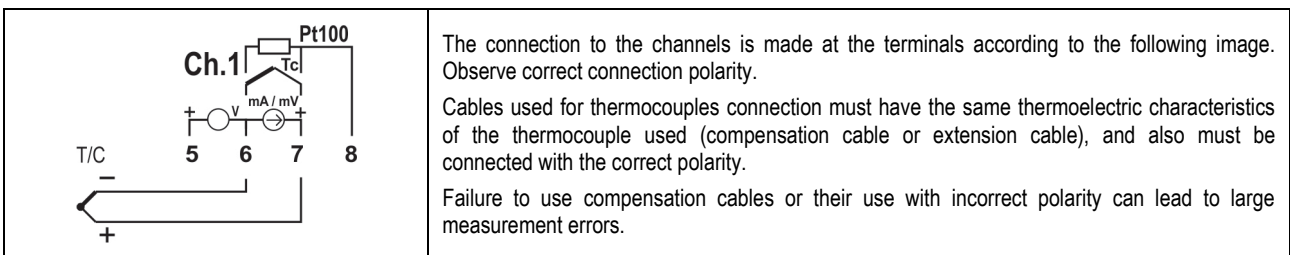

Voltage Connection (mV)

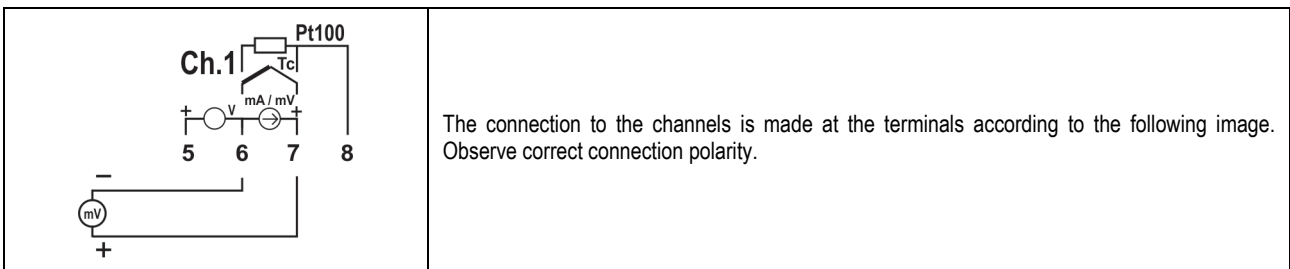

Current Connection (mA)

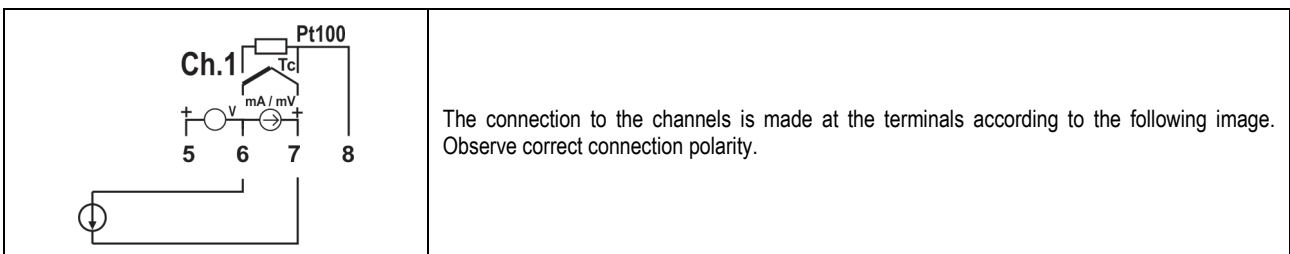

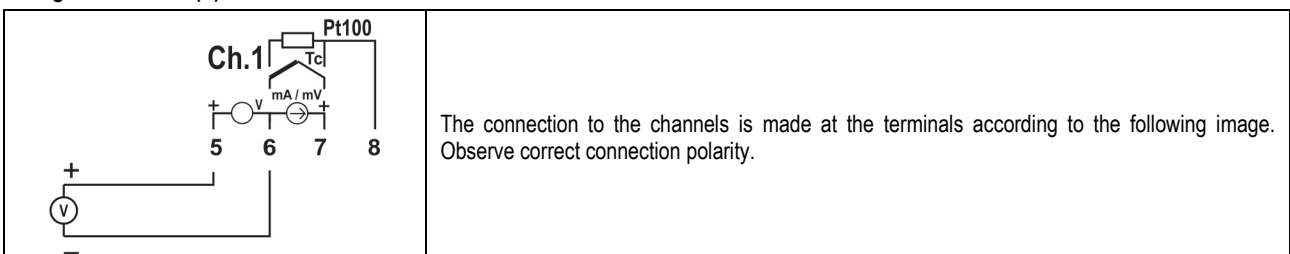

Voltage Connection (V)



12. COMMUNICATION INTERFACES

12.1 USB

The USB interface is the preferred interface for configuring, monitoring, and download equipment logs. It is the only interface which can never be disabled. To access it, you must first install **NXperience** for Windows to install the USB driver (see chapter CONFIGURATION SOFTWARE for more information), and then use a USB cable in the micro-USB standard (not supplied) for desktop or notebook connection. When connecting the USB cable, the icon should light up on the equipment display, indicating that the interface is ready for use. On the first use, wait for Windows to automatically install the driver that was already pre-installed by **NXperience**. The configuration, monitoring, and download of equipment logs via the USB interface must be performed by the **NXperience** software.

	<p>The USB interface is NOT insulated. Its purpose is temporary use during CONFIGURATION, MONITORING, and LOG DOWNLOAD. For people and equipment safety, it should only be used with the equipment completely disconnected from the external power supply input. Using the USB interface in any other connection condition is possible, but requires careful analysis by the person responsible for your installation.</p>
	

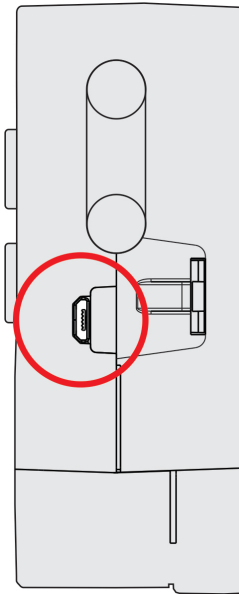

Fig. 40 – USB cable connection

12.2 BLUETOOTH

The **LogBox-BLE** has a *Bluetooth Low Energy* (BLE) interface, compatible with smartphones that have *Bluetooth* modules with a 4.1 or higher version, typically found on *smartphones* running Android 4.4 (KitKat) or higher.

Preferably, the first configuration of the BLE interface must be performed through **NXperience** via the USB interface. However, it is possible to make the first configuration through the **LogChart-BLE** application (see chapter CONFIGURATION SOFTWARE) via the *Bluetooth* interface. By default, **LogBox-BLE** will be factory-configured with a 1-second warning period and SSID "LogBox". Thus, on the first use, the device chosen in **LogChart-BLE** must be identified by the *Bluetooth* MAC on the device identification label, since all **LogBox-BLE** are initially configured with the same SSID.

The following configurations are available for the BLE interface:

- Enabling/Disabling the BLE interface;
- Configuring the device's SSID *Bluetooth* - name by which the device will be recognized by the *smartphone*;
- Configuring the BLE interface's Wake Up Mode:
 - Periodic: At configured frequency, the BLE interface will become available for the *smartphone* to connect to it;
 - Frequency: Configures how often the **LogBox-BLE** will make the BLE interface available for connection. A low frequency makes the connection faster, but increases the device consumption, reducing battery life.
 - Via keyboard - the BLE interface will only become available for your *smartphone* to connect to it after a key is pressed. This option can be selected to save energy.

If the BLE interface is enabled in periodic mode, the  symbol remains lit, indicating that the *Bluetooth* interface is available for connection or that some device is connected. If the interface is configured to wake up via keyboard, the symbol will only remain lit while the device is *advertising*.

To speed up the pairing, if the BLE interface wake-up mode is set to Periodic, every time a key is pressed in the **LogBox-BLE**, the BLE interface will have its frequency reduced to 100 ms for a 60 second interval. This allows the *smartphone* to pair faster with **LogBox-BLE** in this range.

The maximum *Bluetooth* signal range is up to 10 meters without obstacles. However, in order to have a good connection that provides quick data downloads, it is recommended to use a *smartphone* within a maximum distance of 5 meters.



Most smartphones have a *Bluetooth* module integrated with the Wi-Fi module. Thus, their *Bluetooth* interface shares the usage time with the Wi-Fi interface, making both interfaces unavailable for a few milliseconds, one at a time. For most equipment this is no problem, since they do not need to save energy, working with a very low availability frequency (100 ms). Since for the **LogBox-BLE** energy saving is fundamental, it works with a high periodicity (configurable with minimum period of 500 ms). This makes it possible for your *smartphone* to experience difficulties when pairing. In case problems are identified when connecting your *smartphone* to **LogBox-BLE**, two options may resolve the problem:

- Clicking on any product key so that **LogBox-BLE** stays at a low frequency for 60 seconds;
- Disconnecting the Wi-Fi interface from your *smartphone*.

13. TROUBLESHOOTING

Start/Stop Modes: Depending on the start/stop rule that the equipment is configured with, it may lose information if it has to continue or not registering when there is a power failure.

- Start/Stop by keyboard, Modbus command or Digital input may be lost when the equipment is powered up.
- Start/Stop Immediately, Date Hour or Daily will be resumed as soon as the equipment is powered up again and can resume the clock.

Clock: LogBox-BLE, when de-energized, cannot reconfigure the clock on its own. Thus, if the clock information is lost, it will remain not registering until someone sets the clock again.

Alarm Information: Alarm information, maximum and minimum values reached in each channel, as well as Date/Time of the last event are data that can be lost if the equipment is de-energized for more than 30 min. Unless a new configuration is applied or the user requests to clear the memory, only the data recorded in the logs interval or the digital input events (if it is configured for event log) are guaranteed not to be lost. **NXperience** and **LogChart-BLE** have the functionality of reporting the maximum and minimum values logged, as well as informing all logs that are in an alarm situation.

Bluetooth: Most smartphones have a *Bluetooth* module integrated with the Wi-Fi module. Thus, their *Bluetooth* interface shares the time of use with the Wi-Fi interface, making the *Bluetooth* interface unavailable for a few milliseconds while using Wi-Fi. For most equipment this is no problem, since they do not need to save energy, working with a very low availability frequency (100 ms). Since **LogBox-BLE** works at a high frequency (configurable with a minimum of 500 ms) to save energy, it is possible that your *smartphone* may experience difficulties when pairing. In case problems are identified when connecting your *smartphone* to **LogBox-BLE**, two options may resolve the problem: 1 - click on any product key so that **LogBox-BLE** stays at a low frequency for 30 seconds; 2 - Turn off the Wi-Fi interface of your *smartphone*.

Analog Inputs: When using any equipment on the analog inputs that are connected to the mains (e.g., thermocouple or voltage simulator), and it is not isolated, it is recommended to use a different reading interface than USB. In some cases, noise and read offsets have already been detected due to the influence of the USB cable connection, probably by ground loops.

Analog Inputs: The **LogBox-BLE**, when operated by batteries, keeps the entire analog circuit switched off while no acquisition is being made. This strategy is necessary so that it can operate for more than 2 years without needing to change the batteries. However, some analog signal simulators (e.g., thermocouple simulator, Pt100) may not be able to operate correctly with this characteristic, causing false offsets and oscillations in the readings. If such a problem is identified, it is recommended to power the **LogBox-BLE** via external power supply or via USB while using the simulator.

Analog Inputs: It is important to set the local power line frequency (50 Hz or 60 Hz) to improve the reading performance of the analog channels, even if the equipment is running on batteries. The power grid typically causes interference in the signal read from the sensors, which can be more easily mitigated if we know the frequency.

Unregistered Alarms: The alarm status information, as well as the maximum and minimum values reached in each channel, is updated by any events that trigger an acquisition, which may be a read in the log interval or in the display update interval. If a channel reaches a minimum or maximum value or an alarm condition during an acquisition other than the log interval, it may not be logged in the memory. Thus, statuses may indicate that the channel has already reached one of these situations and the information is not available in a data download. The log interval must be configured according to the maximum period allowed by the process being monitored, so that no important information is lost (no longer being logged).

14. WARRANTY

Warranty conditions are available on our website www.novusautomation.com/warranty.